

SAMSUNG **Flip**

Flip the future
of collaboration.



SAMSUNG Flip

Transform the modern meeting.

The meeting is the foundation of today's business world. It can also be one of its most challenging elements. Between preparing and moving supplies, finding a room and making sure every voice is heard, it's easy for game-changing ideas to get lost in the process.

Introducing the Samsung Flip, an interactive display that drives more productive and efficient collaboration without the hassle. With the Samsung Flip, meetings can take place anywhere and at any time, with everything you need always ready to go.

Business meeting logistics no longer need to be stressful and inefficient. The Samsung Flip can help you and your team work smarter, faster and better.





BALANCE SHEET

ASSETS		LIABILITIES	
NET ASSETS		CURRENT LIABILITIES	
Property, plant & equipment	\$20,763.00	Accounts payable	\$1,200.00
Goodwill	\$1,200.00	Accounts receivable	\$1,200.00
Intangible assets	\$1,200.00	Long-term debt	\$1,200.00
Other assets	\$1,200.00	Other liabilities	\$1,200.00
TOTAL ASSETS	\$14,562.00	TOTAL LIABILITIES	\$5,952.00

CURRENT RATIO 3.38 QUICK RATIO 2.91 DEBT TO EQUITY RATIO 0.24 WORKING CAPITAL \$3,761.00



BALANCE SHEET



FI!P Innovation

Whatever your collaborative needs, the Samsung Flip display can improve the quality of any meeting. See your ideas come to life in clear UHD picture quality. Activate the display through sensor recognition to ensure your meeting starts on time. And make any location a meeting space by adding a portable, wheel-based stand. Facilitators and participants can trust the Samsung Flip to enliven any conversation.

FI!P Display

Samsung Flip presents all critical ideas in a clear and consistent format. Regardless of annotation size or style, the Flip display maintains brilliant, eye-friendly UHD picture quality. In turn, you and your colleagues can follow the conversation and remain engaged at all times.



FI!P Touch

Samsung Flip is the ideal forum for simultaneous interaction. Up to four different meeting participants can make notes using the embedded pen or virtually any writing tool such as the blunt end of a pen or pencil. Additionally, you can sync and control content from your personal device to the central screen for efficient collaboration.



*Touch Out Control is available through a touch USB cable connection or UIBC-connected Android mobile device (2016 or later) and Windows 10 PC.

FI!P Design

Whether it's a quick discussion or a lengthy presentation, capturing everyone's ideas during a meeting can now be comfortable. You can customize and work within your ideal writing dimensions. Leverage the optimized pivot height to automatically align the Flip to an ideal level. Utilize the ergonomic 4.5 degree tilt in portrait mode for a more natural writing angle. And configure the display in portrait or landscape orientation to maximize available writing space.

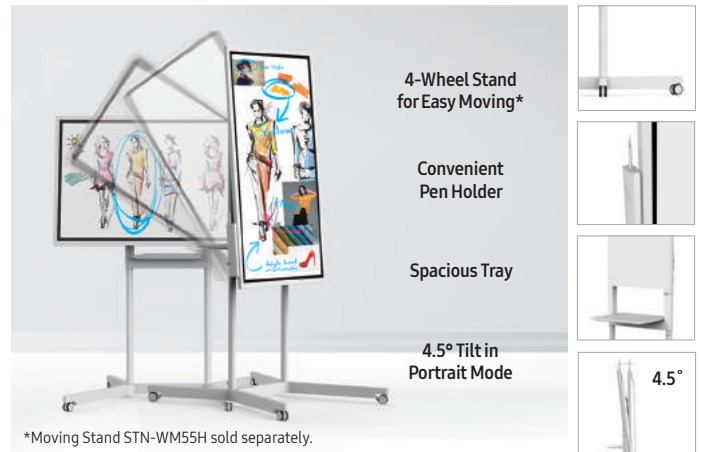

FI!P Solution

The workday is busy, and you can't afford to waste any time. The Samsung Flip helps ensure you aren't waiting for your display to activate, so meetings can start on time. Embedded sensors automatically activate the display when you approach or remove the pen from the holder. Samsung Flip also stores meeting notes in real-time, preventing the need to stop conversation to save each page.





Flip Experience

Take the traditional meeting to the next level. Through the Samsung Flip's mobile connectivity, you can add images, charts or other essential files directly to the Flip from your personal devices, all in a clear, easy-to-read format. The Samsung Flip also provides the same familiar writing experience as a standard analog white board or piece of paper, so you can expand your creativity without sacrificing comfort.

FI!P Notation

The Samsung Flip enables you and your colleagues to bring your unique style to the conversation. The display showcases smooth, fast writing in a variety of colors and depths, with compatibility for multiple writing tools. Need to erase a previous note? You can quickly clear either a small section or a full screen's worth of content using a hand swipe motion.



Passive Pen



Smooth and Fast



Flexible Erasing

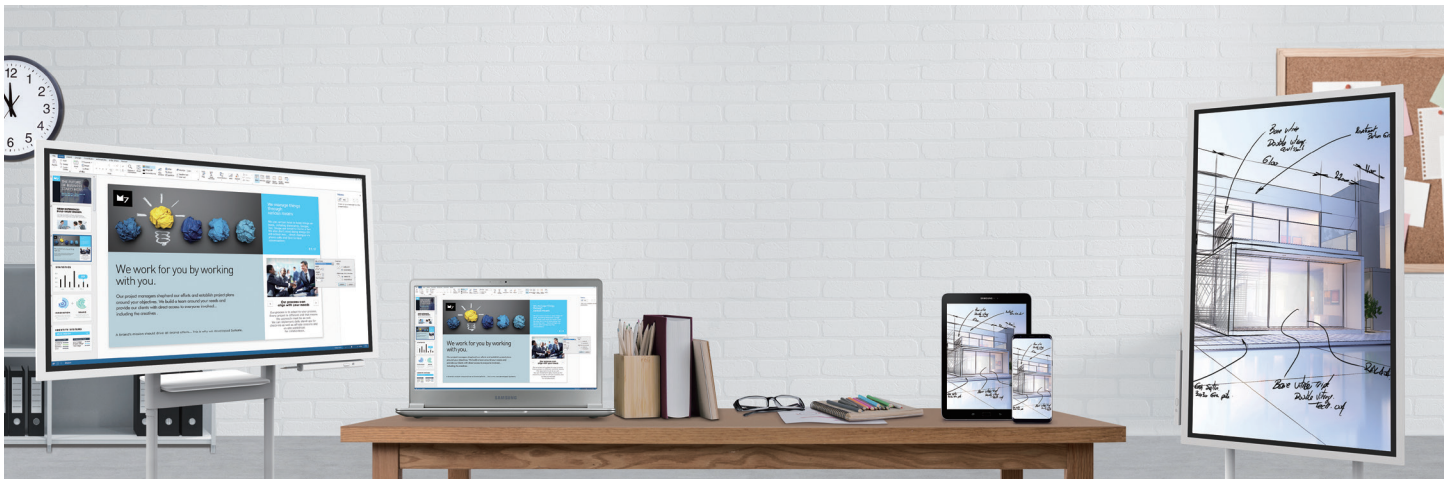
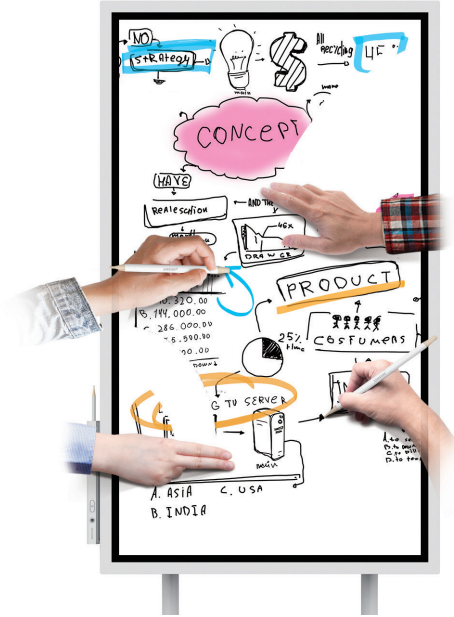

FI!P Connection

Standard meeting technologies make it difficult to locate the input sources required to connect external devices. Samsung Flip's versatile connectivity makes dedicated USB, Note PC, tablet and mobile device ports readily available, saving valuable meeting time while extending participation capabilities.



Note PC



Tablet



Mobile Phone



USB

FI!P Synchronization

Today's workers rely on their mobile devices to stay productive more than any other workplace tool. The Samsung Flip supports the mobile movement through extensive connectivity that makes onscreen content visible without interruption. Touch Out Control functionality¹ allows users to sync their personal devices to the Flip for real-time viewing and control. Changes made on the Flip will automatically transmit to the user's personal device and vice versa, for efficient, matched viewing.



Wireless Windows 10



Touch Out Control¹



NFC²



Screen Mirroring²

¹Touch Out Control is available through a touch USB cable connection or UIBC-connected Android mobile device (2016 or later) and Windows 10 PC.

²Samsung Galaxy Series devices (2016 or later) with an updated Android Oreo OS can launch screen mirroring via NFC tagging. Samsung Galaxy Note 8 and Galaxy Series devices (2016 or later) with an updated Android Oreo OS support full screen mirroring in portrait mode.



Flip Navigation

You and your colleagues no longer have to sort through stacks of paper charts to find specific ideas or conversations. Samsung Flip eliminates this tiresome process by housing all meeting notes in a central storage database, with convenient search and navigation functionalities capable of locating a specific item in seconds. Detailed previewing also shows how a recap will look before it's shared with live and remote participants.



Page Preview



Quick Finder



Capture and Annotation



FI!P Presentation

The Samsung Flip offers added flexibility for a flawless presentation in any format. Regardless of huddle room dynamics, your colleagues and you can showcase content in portrait or landscape mode, thanks to convenient pivot functionality. The Samsung Flip also adds simplified organization through clear page dividers, with the ability to quickly scroll through up to 20 pages at a time.

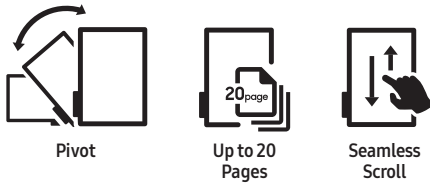

FI!P Distribution

If you've ever had to capture handwritten meeting notes or send a detailed recap to your team, you know how time-consuming and potentially frustrating it can be. Samsung Flip eliminates the need for this cumbersome process through easy storage and distribution. Now you can send accurate digital notes to your colleagues via email, printing*, and network or USB storage, saving time while also preventing important ideas from being lost.

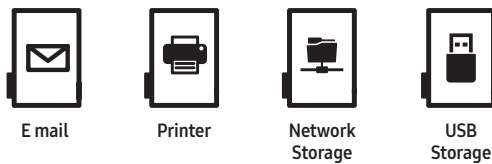

*Flip users can print notes only via a Windows 7 or 10 OS-powered server or machine. Server software is also available at www.samsung.com.

FI!P Protection

Although the Samsung Flip allows for many users and access points, it also ensures confidential meeting information remains in the right hands. The Flip's airtight, password-based security system will safeguard your most important documents. The result is a freer and more boundless exchange of ideas that can benefit any business.

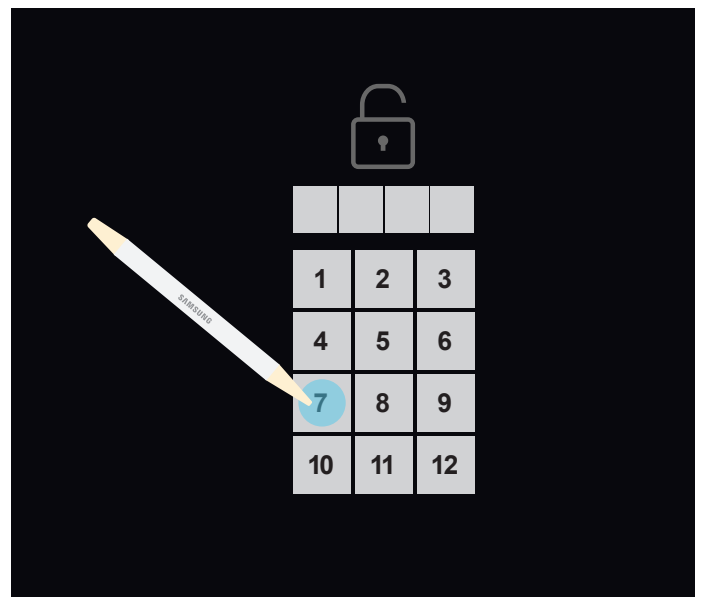
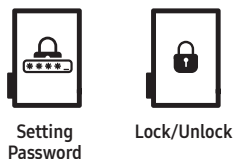



Flip Story

Regardless of your industry or work environment, the Samsung Flip is the perfect addition to any meeting style or environment. The Flip's diverse features and functions accommodate both creative and information-based businesses, promoting a more seamless and interactive team dynamic. Any team working in any industry stands to benefit from the faster, clearer and more organized exchange of ideas now made possible by the Samsung Flip.

FI!P Spaces

Communal Office

Transform any Space into a Huddle Room

For businesses with limited meeting space, Samsung's Flip display opens new avenues for idea generation. The display's portable stand* transforms any space into a meeting room, with a convenient wall mount also available for temporary installations. For added convenience, the Flip's central screen, push button and pen lift recognition immediately activate the display to ensure meetings start on time. A sleek, stylish design also brings performance and sophistication to any meeting environment.

*Moving Stand STN-WM55H sold separately.



FI!P Insights

Digital Marketing Agency

Condense Widespread Collaboration to a Single Space

For projects involving multiple stakeholders and documents, Samsung's Flip display drives more centralized and efficient teamwork. Up to four participants can write simultaneously, and facilitators and attendees can also share ideas and content from connected mobile devices. As meetings conclude, participants can digitally share and review notes, eliminating the need for a written recap.



FI!P Ideas

Design Boutique

Explore Unlimited Creative Possibilities

Samsung's interactive Flip display empowers creatively driven businesses to develop messages that resonate with colleagues and clients. Visual storytellers can customize text styles, colors and sizes, all while enjoying a familiar and comfortable writing experience. The Samsung Flip also offers sufficient writing space and centralized storage to ensure an uninterrupted exchange of game-changing ideas.



FI!P Views

Architect Office

Expand the Workspace in an All-in-One Format

Narrow work spaces and stacks of paper can prevent architects' ideas from reaching full potential. Through streamlined creativity and organization, Samsung's Flip display helps architects achieve more efficient design, presentation and supervision. Centralized storage prevents misplacement by housing all relevant documents in a single, easily accessible location. The Flip's pivot flexibility also expands available drawing space in both portrait and landscape modes.



Flip Specifications

Flip Display				
Panel	Diagonal Size		55"	
	Type		60Hz E-LED	
	Resolution		3,840 x 2,160 (Landscape) 2,160 x 3,840 (Portrait)	
	Brightness (Typ.)		300 (without glass), 220 (with glass)	
	Contrast Ratio (Typ.)		4700:1 (without glass)	
	Viewing Angle (H/V)		178:178	
	Response Time (G-to-G)		8ms (Typ.)	
Sound	Speaker Type		Built in Speaker (10W x 2)	
Connectivity	Input	Video	HDMI 1	
		USB	USB 2 (Ver 2.0 x 2, Side 1, Sensor Assy 1)	
	Output	Touch Out	Touch Out 1 (Side, USB Upstream Type)	
	Internal	Sensor	NFC, Acceleration Sensor, Proximity Sensor	
	External	Control	Touch Input RJ45 (Not for User Control)	
Touch	Type		Advanced IR	
	Number of Simultaneous Drawing		4 Users Drawing Simultaneously	
	Touch Pen Type		Passive Pen	
	Object Recognition Range		2mm / 4mm / 8mm / 50mm (0.08" / 0.16" / 0.32" / 1.2")	
	Touch Response Time		38ms ~ 46ms (According to number of Multi Drawings)	
Power	Type		Internal	
	Power Supply		AC 100~240V 50/60Hz	
	Power Consumption	Max (W/h)	165	
		Typical (W/h)	100	
		Rating (W/h)	150	
		Standby (W/h)	0.5	
	BTU (W/h)	562.65		
Mechanical	Dimensions	Display (W x H x D)	51.3" x 31.7" x 2.04"	
		Package (W x H x D)	57.8" x 36.4" x 8.3"	
	Weight	Display	63.7 lbs.	
		Package	76.9 lbs.	
	Color		Light Gray	
	VESA Mount		400 x 400	
	Protection Glass		Yes	
	Stand Type		Moving Stand (STN-WM55H Sold Separately), Wall Mount (WMN-6575SD Sold Separately)	
	Rotation		Available with Optional Moving Stand STN-WM55H (Rotation Cylinder Included)	
	Power Cable Length		3m	
	Operation	Operating Temperature		32° ~ 104°F
	Feature	Humidity		10~80%
		Key		Flip App
Special		H/W	Super Clear Coating, Temperature Sensor, Pivot Display, Clock Battery (168 hrs Clock Keeping), Built in Speaker (10W x 2), Wi-Fi Module Embedded	
		S/W	Flip S/W	
		Platform	Kant-M (Tizen 3.0)	
Internal Player (Embedded H/W)		Processor	CA72 Quadv(1.7GHz)	
		On-Chip Cache Memory	L1 (I/D): 32KB / 32KB L2 (Unified): 1MB	
		Clock Speed	1.7GHz CPU Quad	
		Main Memory Interface	LPDDR4 1400MHz 64bit 3GB	
		Graphics	2D and 3D Graphics Engine, Up to 1920 x 1080, 32 bpp, Supports OpenGL ES	
		Storage	8GB (2.65GB Occupied by O/S, 5.35GB Available)	
		Multimedia	Video Decoder: MPEG-1/2/4, H.263, H.264/AVC, UHD H.264/AVC, VC-1, AVS+, HEVC, JPEG, PNG, VP8, VP9 Audio Decoder: AC3 (DD), MPEG	
		IO Ports	USB 2.0	
Operating System		Samsung Proprietary OS (VD Linux)		
Accessories	Included		Passive Pen (2), Power Cable, Touch Out Cable (USB Upstream)	
	Optional	Stand	STN-WM55H	
		Mount	WMN-6575SD	

Flip Moving Stand (Sold Separately)			
Mechanical	Dimensions	Stand (W x H x D)	40.3" x 63.4" x 39.0"
		Package (W x H x D)	66.2" x 87" x 40.9"
	Weight	Stand	69.9 lbs.
		Package	92.2 lbs.
	Color		Light Gray
	VESA Mount		400 x 400
Rotation		Pivot Supports (90°)	
Connectivity	Extension Connectivity from Flip Set		HDMI1 / Touch Out 1 / RJ45 1 / Power 1
Accessories	Included		Installation Guide
Feature	Special	H/W	Rotation (4 Wheels) / Pivot (90°) / Pen and Note PC Tray (Rear)

Technical Drawing



Flip Landscape Dimension

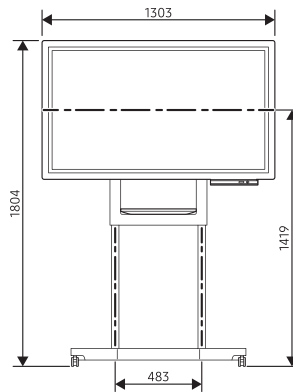

Flip Portrait Dimension

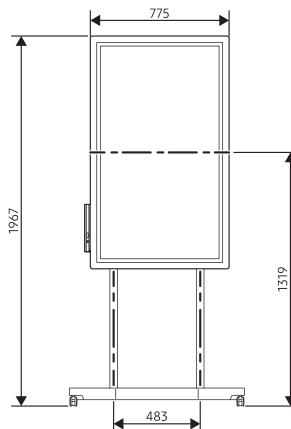

FIIP Installation Guide

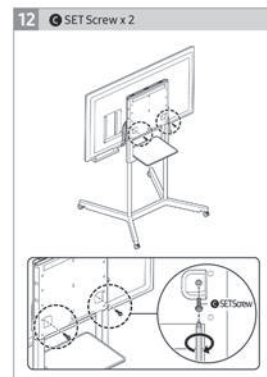
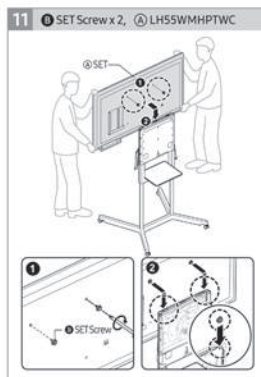
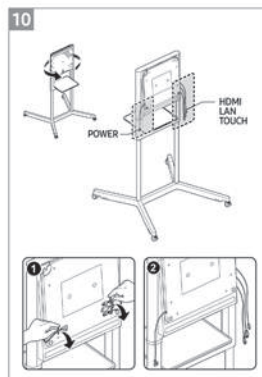
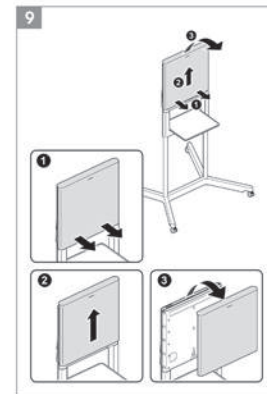
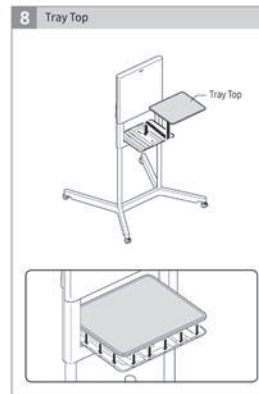
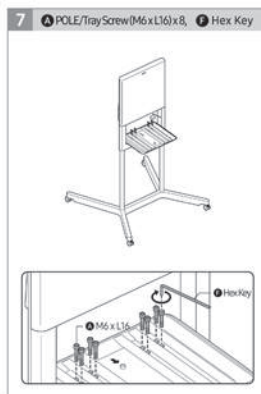
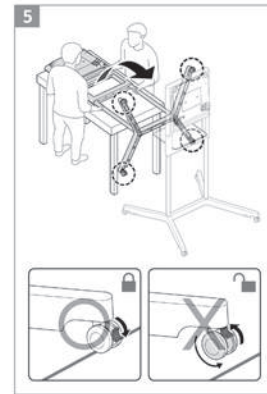
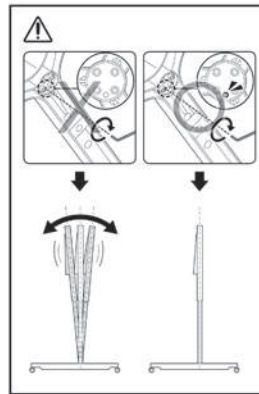
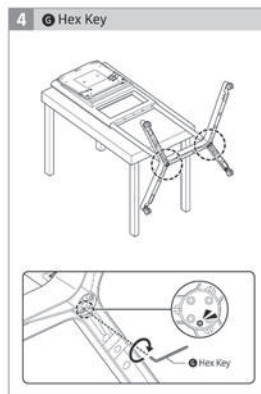
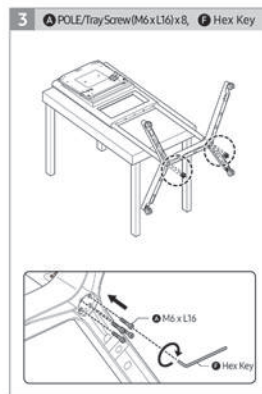
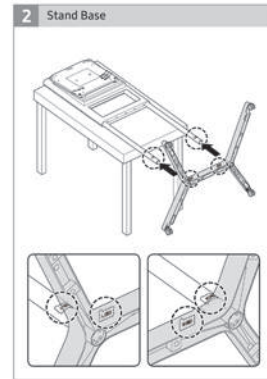
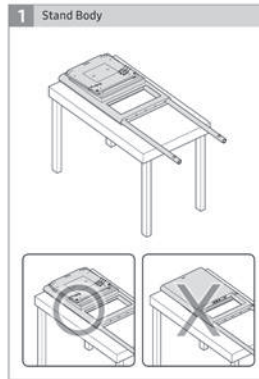
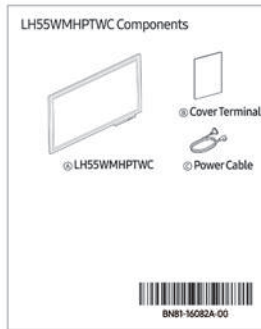
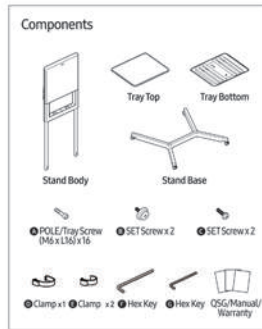

Quick Setup Guide

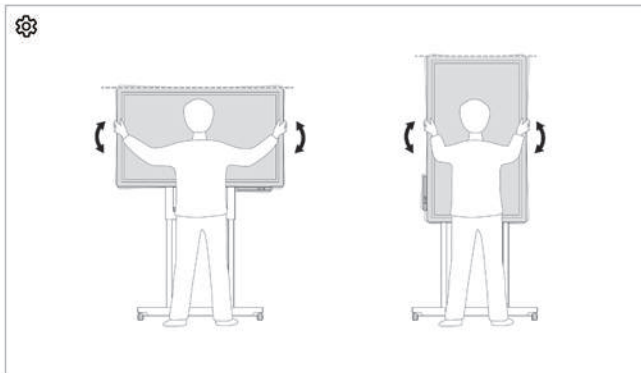
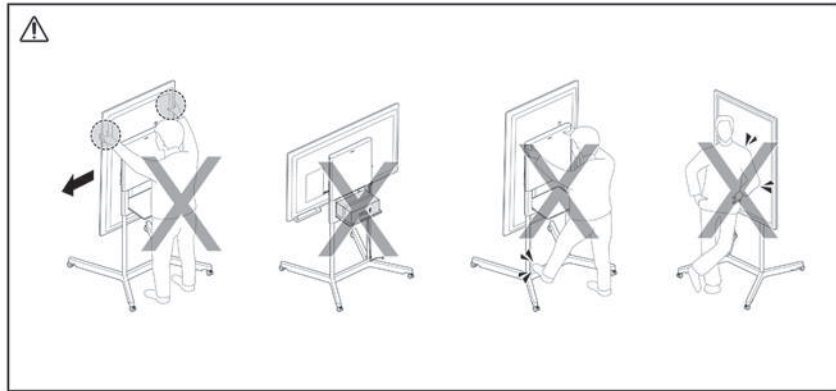
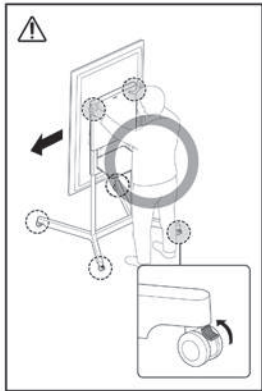
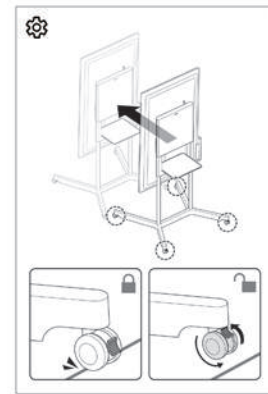
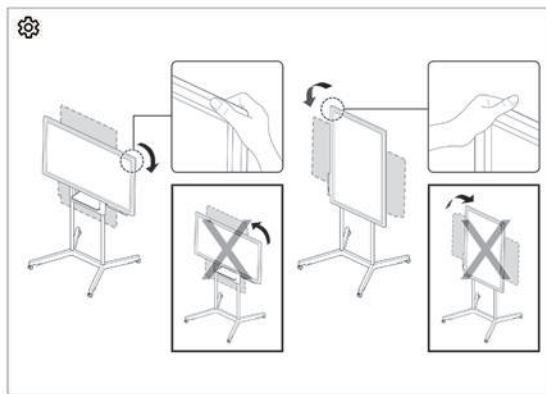
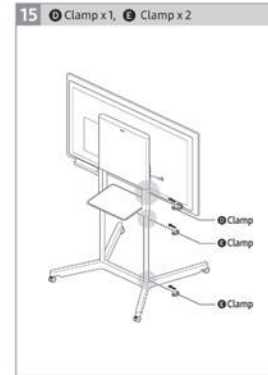
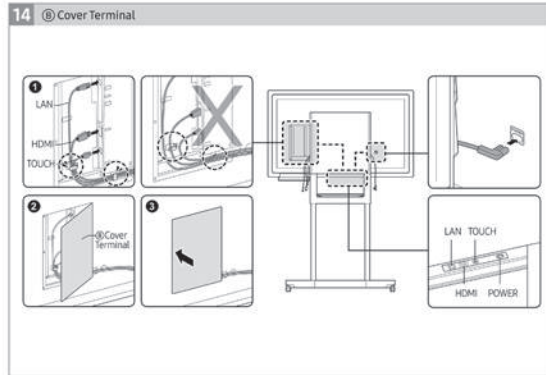
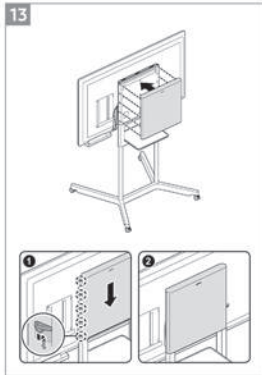



Model Name		STN-WM55H
Size (W x H x D)	(Without Flip)	1039 x 1622 x 1007 mm
	Landscape (With Flip)	1303 x 1804 x 1007 mm
	Portrait (With Flip)	1039 x 1967 x 1007 mm
Weight (Without Flip)		31.7 ±0.5 Kg
Packing Size (W x H x D)		1682 x 221 x 1038 mm
Packing Weight		41.8 ±0.5 Kg
Compatible model		LH55WMHPTWC

SAMSUNG Flip

For complete product information and accessories, visit samsung.com/business insights.samsung.com samsung.com/b2bdigitalsignage
Product support: 1-866-SAM4BIZ | Follow us:  youtube.com/samsungbizusa  [@SamsungBizUSA](https://twitter.com/SamsungBizUSA)

©2017 Samsung Electronics America, Inc. Samsung is a registered mark of Samsung Electronics Corp., Ltd. Specifications and design are subject to change without notice. Non-metric weights and measurements are approximate. Simulated screen images. All brand, product, service names and logos are trademarks and/or registered trademarks of their respective manufacturers and companies. See samsung.com for detailed information. Printed in U.S.A. on recycled (10% post-consumer waste) paper using soy inks. LFD-FLIPBRO-DEC17T

