



Electric Utility

ENERGY PRODUCTS FOR POWER GENERATION,
TRANSMISSION & DISTRIBUTION



Electric Utility

This catalog contains in-depth information on the most comprehensive line of utility products available today for the electric utility marketplace.

The product and technical sections have been developed with an easy-to-use “spec-on-a-page” format. They feature the latest information on electric utility products, from applications and construction to detailed technical and specification data. There’s also a user-friendly index.

From low-, medium-, high- and extra-high-voltage wire and cable for power generation, distribution and transmission, both overhead and underground, General Cable offers a broad spectrum of cables for electric utilities, rural electric co-ops and independent power producers.



All information in this catalog is presented solely as a guide to product selection and is believed to be reliable. All printing errors are subject to correction in subsequent releases of this catalog. Although General Cable has taken precautions to ensure the accuracy of the product specifications at the time of publication, the specifications of all products contained herein are subject to change without notice.

GENERAL CABLE, SILEC, BIFILL, CL, E3X, EMPOWR, FREP, MASTERPAK, NUAL, POWRNET, POWRPAK, POWRSERV, STRANDFILL, T-2, TRANSPWR, TRIFILL, ULTRAPOWR, UNIBLEND and VNTC are trademarks of General Cable Technologies Corporation.

General Cable’s patent website lists the products that are protected by the U.S. patents indicated, and may potentially be protected with additional U.S. patents, non-U.S. patents, and/or pending patent applications. It is possible that other products, not listed, may be protected by the patents indicated below and/or otherwise. Visit www.generalcable.com/patent.

© 2016. General Cable Technologies Corporation. Highland Heights, KY 41076
All rights reserved. Printed in USA.

What’s New?

REDUCE YOUR COSTS AND INCREASE YOUR POWER WITH E3X® TECHNOLOGY



Groundbreaking E3X Technology allows utilities to optimize the power grid by adding more capacity and controlling losses with significant first-cost and long-term operational savings. TransPowr® with E3X Technology features a thin, durable coating that is applied to the surface of any TransPowr overhead conductor. This heat-dissipating coating increases emissivity and reduces absorptivity, improving energy effectiveness and efficiency by allowing for a higher ampacity rating, reduced operating temperature and lower losses for a given conductor size or reduced conductor size for a given ampacity rating—transforming power grid sustainability, reliability, resilience and cost of ownership.

SILEC® BRAND HIGH- & EXTRA-HIGH-VOLTAGE CABLE SYSTEMS



The Silec Brand name has been synonymous with solid-dielectric extruded cable solutions for over fifty years. General Cable offers a fully integrated approach to providing a comprehensive range of quality Silec high- and extra-high-voltage cable systems. They are designed, engineered, manufactured and installed to ensure maximum service life and best-in-class performance while maintaining cost effectiveness.

EMPOWR® LINK CL™ ADVANTAGE



Medium-Voltage Collection System Cable – Generating Results through Innovation

EmPowr® Link CL™ Advantage Cable is the next step in medium-voltage technology to deliver industry-leading reliability and performance for solar and wind energy collection systems. General Cable’s EmPowr Link CL Advantage Cable offers superior physical protection to endure the rigors of today’s collection system installation methods. This cost-effective cable solution is built upon widely accepted electrical advances in Cross-linked Polyethylene (XLPE) jacketing and optimized neutral designs to provide a compact, lightweight cable delivering more *Advantage* than ever before. For more information, ask your sales representative.

FULL LINE CATALOGS



Building Wire

General Cable’s building copper wire and cable products include XHHW-2 and tri-rated USE-2. Canadian constructions such as RW90, RWU90 and T90 are also readily available. Our THHN copper products come in a variety of colors and offer a low-friction jacket designed to improve installation even under the most difficult conditions. For today’s solar energy projects, General Cable offers a complete line of SunGen® solar photovoltaic wire in copper constructions.

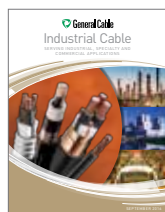

Industrial Cables

When you specify General Cable, not only are you assured of product excellence from legacy cables such as UniBlend®, FREP® and VNVC®, but you also have access to the most extensive line of high-quality innovative and commodity industrial low- and medium-voltage cables available anywhere in the industry. While most cable manufacturers try to fit your needs to their existing products, if you cannot find what you require within our thousands of cable constructions, General Cable will design and manufacture cables around your environment.



PRODUCT SELECTION LOCATOR

SECTION		PAGES
1	Low-Voltage Power Cable	1-13
2	Medium-Voltage Power Cable	14-43
3	High- and Extra-High-Voltage Transmission Cable	44-49
4	Overhead Conductors	50-134
5	Miscellaneous Products	135-142
6	Stock Program	143
7	Handling Recommendations and Packaging Information	144-146
8	Code Word Classifications and Index	147-150

Table of Contents

SECTION	PAGES
1 Low-Voltage Power Cable	1-13
PowrServ® Description	1
Underground Distribution Cable	
• USEI-75	2-3
• USEI-90	4-5
• USEB-90	6-7
Service Drop Cable Neutral-Supported	
• Duplex Type NS75	8
• Triplex Type NS75	9
• Quadruplex Type NS75	10
• Duplex Type NS75/NS90	11
• Triplex Type NS75/NS90	12
• Quadruplex Type NS75/NS90	13
2 Medium-Voltage Power Cable	14-43
EmPowr® Description	14-16
Concentric Neutral Underground Distribution Cable	
• 15 kV CU or AL Conductor	17-20
• 25 kV CU or AL Conductor	21-22
• 28 kV CU or AL Conductor	23-24
• 35 kV CU or AL Conductor	25-26
• EmPowr Link CL™	27-28
• EmPowr Link CL Advantage	29-30
• PowrPak®	31-32
Flat Strap – PILC Replacement Cable	
• 15 kV & 25 kV CU Conductor	33-34
Copper Tape Shielded Power Cable	
• 5 kV & 15 kV CU Conductor	35
• 5 kV & 15 kV AL Conductor	36
• 25 kV, 35 kV & 46 kV CU Conductor	37
• 25 kV, 35 kV & 46 kV AL Conductor	38
Longitudinally Applied Corrugated Tape (LACT) Shielded Power Cable	
• 15 kV CU Conductor	39
• 15 kV AL Conductor	40
• 25 kV & 35 kV CU Conductor	41
• 25 kV & 35 kV AL Conductor	42
3 High- and Extra-High-Voltage Transmission Cable	44-49
4 Overhead Conductors	50-134
TransPowr® Description	50-52
Bare Overhead	
• TransPowr with E3X® Technology	53-56
• A1 (ASC) Aluminum Stranded Conductor	57-62
• Compact (Smooth Body) ASC Aluminum Stranded Conductor	63-66
• AAC/TW Trapezoidal Aluminum Stranded Conductor	67-72
• A2 (AASC) Aluminum Alloy Stranded Conductor	73-76
• ACSR Aluminum Conductor Steel-Reinforced	77-86

Table of Contents

SECTION	PAGES	
4	Overhead Conductors (Cont'd.)	50-134
	<ul style="list-style-type: none"> • Compact (Smooth Body) ACSR Aluminum Conductor Steel-Reinforced87-90 • ACSR/TW Trapezoidal Aluminum Conductor Steel-Reinforced91-98 • ACSS Aluminum Conductor Steel-Supported99-108 • ACSS/TW Trapezoidal Aluminum Conductor Steel-Supported109-116 • ACSR/SD Self-Damping Aluminum Conductor Steel-Reinforced.....117-122 • ACCC®/TW Trapezoidal Aluminum Conductor Composite Core*123-126 	
	Covered Overhead Conductor — Line Wire	
	• Covered Overhead Conductor Line Wire — ACSR, ASC, MHD127-130	
	Covered Overhead Conductor — Tree Wire	
	• AAC — Single Layer 5 kV Tree Wire131	
	• AAC — Dual Layer 15 kV Tree Wire.....131	
	• AAAC — Single Layer 5 kV Tree Wire.....132	
	• AAAC — Dual Layer 15 kV Tree Wire132	
	• ACSR — Single Layer 5 kV Tree Wire133	
	• ACSR — Dual Layer 15 kV Tree Wire133	
	Aluminum Tie Wire	
	• Aluminum Tie Wire.....134	
5	Miscellaneous Products	135-142
	Miscellaneous Products Description.....135	
	• Bare Soft Copper Grounding Conductor136	
	• DSA CCS Copper Clad Steel Grounding Conductor137	
	• Steel Overhead Ground Wire and Steel Guy Wire.....138	
	• 600 V RW90 NUAL® Brand Aluminum Insulated Conductors139	
	• 600 V RW90 Copper Insulated Conductors140	
	• 1000 V RWU90 NUAL® Brand Aluminum Insulated Conductors141	
	• 1000 V RWU90 Copper Insulated Conductors142	
6	Stock Program	143
7	Handling Recommendations and Packaging Information	144-146
	• Recommended Reel Handling Procedures144-145	
	• Standard Package and Shipping Information146	
8	Code Word Classifications and Index	147-150

* ACCC is a registered trademark of CTC Global Corporation.

One Company Connecting The World

POWERFUL PRESENCE · PRODUCTS PERFORMANCE · PEOPLE

General Cable has been a wire and cable innovator for over 170 years, always dedicated to connecting and powering people's lives. We are one of the largest wire and cable manufacturers in the world.

Our company serves customers through a network of manufacturing facilities in our core markets and has worldwide sales representation and distribution. We are dedicated to the production of high-quality aluminum, copper and fiber optic wire and cable and systems solutions for the energy, construction, industrial, specialty and communications sectors. With a vast portfolio of products to meet thousands of diverse application requirements, we continue to invest in research and development in order to maintain and extend our technology leadership by developing new materials, designing new products, and creating new solutions to meet tomorrow's market challenges.

In addition to our strong brand recognition and strengths in technology and manufacturing, General Cable is also competitive in such areas as distribution and logistics, marketing, sales and customer service. This combination enables us to better serve our customers globally and as they expand into new geographic markets.

General Cable offers our customers all the strengths and value of a large company, but our people give us the agility and responsiveness of a small one. We service you globally and locally.



Visit our Website at
www.generalcable.com



Corporate Social Responsibility

CREATING SHARED VALUE

General Cable believes corporate social responsibility (CSR) is about creating shared value. That means keeping a dual focus in our business decisions: what is good for us as a company and what contributes to the greater good of the communities in which we live and work.



SAFETY

Working safer by working together

General Cable has one worldwide safety vision and goal – **ZERO & BEYOND**. We measure safety performance globally, share best practices and implement sound health and safety management systems. Many of our facilities worldwide are OHSAS 18001 (safety management system) certified. All North American facilities have implemented an equivalent health and safety management system. General Cable was a pioneer in obtaining the OHSAS 18001 Certificate for Occupational Health and Safety Management Systems in Europe and North Africa.



SUSTAINABILITY

Responsible practices in daily operations

As a global leader in the wire and cable industry, General Cable recognizes its role and responsibility in promoting sustainability. Our strongest business value is continuous improvement in all areas of our company. Across our many businesses, the quest to introduce new and better products through continuous improvement in environmental designs reflects our commitment to achieving industry-leading standards and responding proactively to global environmental issues. General Cable was the first cable manufacturer to obtain certification for its environmental management system, in accordance with the ISO 14001 and EMAS Standards.



CITIZENSHIP

A commitment to being good citizens

Being responsible citizens in our communities is of the utmost importance to us. Unequivocal honesty, integrity, forthrightness and fair dealing have long been part of General Cable's core values and are expected globally in all of our business relationships with our customers, employees, suppliers, neighbors and competitors. Our company leaders and employees strive to make a difference throughout a host of volunteer activities and financial support, improving the communities in which we live and work.



INNOVATION

Technologies that power and connect the world

General Cable is delivering innovation that matters. We are focusing on R&D expertise and investing in developing wire and cable solutions that meet the challenges confronting our customers and the world. In working together and using all the ingenuity and creativity we have, we will reach the goal of being the preeminent supplier of wire and cabling solutions in the industry, with both green constructions and designs for the ever-growing renewable energy market.



A commitment to achieving industry-leading standards and responding proactively to environmental global issues.

+1.859.572.8000
info@generalcable.com

Visit www.GeneralCableCSR.com
to learn more.



Notes

Low-Voltage Power Cable

PowrServ® Underground Secondary Distribution Cable

General Cable manufactures a complete line of insulated underground secondary cable. General Cable's PowrServ® service cables are intended to provide power from secondary power transformers that are pad-mounted.

General Cable's PowrServ® PE USEI-75 and PowrServ® XL USEI-90 underground service entrance cable consists of two, three, or four Class B compact 1350 aluminum conductors individually insulated with black PE insulation (USEI-75) or black RW90 XLPE insulation (USEI-90), jacketed with coloured PVC and twisted together. PowrServ® PE USEI-75 cables are rated for 75°C maximum conductor temperature under normal conditions. PowrServ® XL USEI-90 cables are rated for 90°C maximum conductor temperature under normal conditions.

General Cable's PowrServ® XL USEB-90 underground service entrance cable consists of two Class B compact 1350 aluminum conductors individually insulated with black RW90 XLPE insulation, laid in parallel, with a helical plain copper wire serving and an overall PVC jacket covering. PowrServ® XL USEB-90 cables are rated for 90°C maximum conductor temperature under normal conditions.

Underground secondary and service entrance cables are manufactured in accordance with CSA Standard C22.2 No. 52.

General Cable's PowrServ® service cables are available in numerous insulation types, conductor alloys and numbers of conductors to meet a customer's particular requirements. The most common styles are generally available from stock.

PowrServ® Underground Cable Options

- **Copper Conductor** – Primarily used when more ampacity is needed and/or there are limitations to the overall cable diameter.
- **Alloy 8000 Aluminum Conductor (ACM)** – NUAL® Brand
- **Reeless Package** – Supplied in coils without the wooden reel. Provides an environmentally friendly packaging option to avoid the disposal cost and save landfill space.
- **Other Phase Identification Methods** – Identified by coloured extruded stripes.
- **Combined Duct & Cable** – Designed for direct burial. The pre-installed system reduces the installation and repair cost. Various designs of wall thickness HDPE conduits are available.

PowrServ® Overhead Secondary Distribution Cable

General Cable manufactures a complete line of insulated products for overhead secondary distribution.

General Cable's PowrServ® overhead service cables are intended to provide power from secondary power transformers that are pole-mounted. The overhead service cables can also be used as pole line secondary with service splices at the pole or mid-span.

General Cable's PowrServ® overhead products consist of a Class A compact 1350-H19 aluminum conductor insulated with LLDPE (NS75) or XLPE (NS75/NS90) around a compact ACSR neutral and manufactured in accordance with CSA Standard C22.2 No. 129.

General Cable's PowrServ® overhead service cables are available in numerous insulation types, conductor alloys and numbers of conductors to meet a customer's particular requirements. The most common styles are generally available from stock.

PowrServ® Overhead Cable Options

- **Copper Conductor** – Primarily used when more ampacity is needed and/or there are environmental corrosion concerns.
- **FT1-Rated Cross-linked Polyethylene Insulation** – FT1-rated flame-retardant insulation.
- **Colour-Coded PVC Jacket** – Provides phase identification and FT1-rated flame retardancy.
- **A2 Messenger** – Concentric stranded Class A, 6101-T81 aluminum alloy stranded neutral messenger conductor (A2).
- **A2/S3A (AACSR) Messenger** – Concentric stranded Class A, 6101-T81 aluminum alloy – high strength steel-reinforced stranded neutral messenger conductor.
- **Other Phase Identification Methods** – Printed numbers on black coloured insulation or extruded coloured stripes.
- **Corrosion Inhibitor** – Conductor corrosion-resistant inhibitor treatment.
- **Reeless Package** – Supplied in coils without the wooden reel. Provides an environmentally friendly packaging option to avoid the disposal cost and save landfill space.

Index	Page
Underground Distribution Cable	
USEI-75	2-3
USEI-90	4-5
USEB-90	6-7
Service Drop Cable Neutral-Supported	
Duplex Type NS75	8
Triplex Type NS75	9
Quadruplex Type NS75	10
Duplex Type NS75/NS90	11
Triplex Type NS75/NS90	12
Quadruplex Type NS75/NS90	13



PowrServ® PE Underground Secondary Cable Type USEI-75

600 V, Aluminum Conductor, LLDPE Insulation, PVC Jacket

Product Construction:

Complete Cable:

USEI-75 Underground Service Entrance Cable consists of two, three, or four compact aluminum conductors individually insulated with 75°C black PE insulation, jacketed with coloured PVC and twisted together. The neutral conductor will be white. The product is CSA Certified and meets the USEI-75 cable requirements of CSA C22.2 No. 52.

Conductors:

The aluminum stranded conductors are Class B compact 1350 aluminum.

Insulation:

The insulation is a sunlight-resistant, black, Linear Low-Density Polyethylene (LLDPE) meeting the requirements of CSA C22.2 No. 52 for 75°C wet and dry rated polyethylene.

Jacket:

Over top of the insulation, a continuous layer of PVC is extruded. The jacket is a weather- and sunlight-resistant, non-sulphide-staining, cut-through-resistant, 75°C/-40°C FT1-rated material.

Neutral Conductor:

One of the insulated conductors is identified as a neutral conductor by the use of a white coloured PVC jacket. The neutral conductor may be the same size as the power conductor, or it may be reduced.

Phase Identification:

Phase identification is provided by means of jacket colour coding. Three conductor cable consists of a red and a black coloured power conductor and a white coloured neutral. Four conductor cable consists of a red, black, and blue coloured phase conductor and a white coloured neutral. All cables provided with sequential print marking.

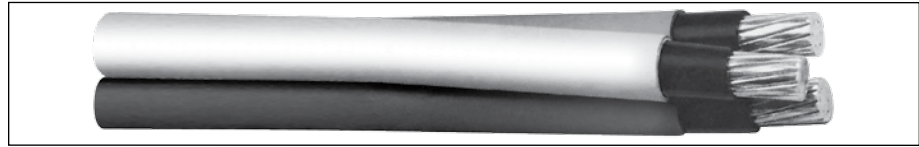

THREE CONDUCTOR TYPE USEI-75 – LLDPE/PVC – 600 VOLTS										
PHASE CONDUCTORS				FULL NEUTRAL CONDUCTOR				OVERALL		
SIZE (AWG OR kcmil)	NO. OF WIRES (1)	INS. THKN. (mm)	JACKET THKN. (mm)	SIZE (AWG OR kcmil)	NO. OF WIRES (1)	INS. THKN. (mm)	JACKET THKN. (mm)	EFFECTIVE DIAMETER (mm)	APPROX. WEIGHT (kg/km)	AMPACITY (2)
4	7	1.14	0.76	4	7	1.14	0.76	20	323	65
2	7	1.14	0.76	2	7	1.14	0.76	23	457	90
1	19	1.40	1.14	1	19	1.40	1.14	27	627	100
1/0	19	1.40	1.14	1/0	19	1.40	1.14	29	745	120
2/0	19	1.40	1.14	2/0	19	1.40	1.14	32	890	135
3/0	19	1.40	1.14	3/0	19	1.40	1.14	34	1067	155
4/0	19	1.40	1.14	4/0	19	1.40	1.14	37	1288	180
250	37	1.65	1.65	250	37	1.65	1.65	43	1625	205
350	37	1.65	1.65	350	37	1.65	1.65	48	2132	250
500	37	1.65	1.65	500	37	1.65	1.65	55	2867	310

(1) Actual number of wires may differ for compact round stranded aluminum conductors using single input wire (SIW) or compact round concentric-lay-stranded aluminum conductors.
 (2) The ampacity ratings are based on Table 4 of the 2015 Canadian Electric Code (C22.1) (75°C conductor temperature, 30°C ambient). Ampacity ratings may be used for single circuit applications of cables directly buried, in buried duct, in duct bank, or in conduit.

Dimensions and weights not designated minimum or maximum are nominal values and subject to manufacturing tolerances. In this context, weight means mass.

PowrServ® PE Underground Secondary Cable Type USEI-75

600 V, Aluminum Conductor, LLDPE Insulation, PVC Jacket

FOUR CONDUCTOR TYPE USEI-75 – LLDPE/PVC – 600 VOLTS										
PHASE CONDUCTORS				FULL NEUTRAL CONDUCTOR				OVERALL		
SIZE (AWG OR kcmil)	NO. OF WIRES (1)	INS. THKN. (mm)	JACKET THKN. (mm)	SIZE (AWG OR kcmil)	NO. OF WIRES (1)	INS. THKN. (mm)	JACKET THKN. (mm)	EFFECTIVE DIAMETER (mm)	APPROX. WEIGHT (kg/km)	AMPACITY (2)
4	7	1.14	0.76	4	7	1.14	0.76	22	431	65
2	7	1.14	0.76	2	7	1.14	0.76	26	610	90
1	19	1.40	1.14	1	19	1.40	1.14	31	835	100
1/0	19	1.40	1.14	1/0	19	1.40	1.14	33	993	120
2/0	19	1.40	1.14	2/0	19	1.40	1.14	35	1186	135
3/0	19	1.40	1.14	3/0	19	1.40	1.14	38	1422	155
4/0	19	1.40	1.14	4/0	19	1.40	1.14	42	1717	180
250	37	1.65	1.65	250	37	1.65	1.65	48	2167	205
350	37	1.65	1.65	350	37	1.65	1.65	54	2843	250
500	37	1.65	1.65	500	37	1.65	1.65	61	3823	310

(1) Actual number of wires may differ for compact round stranded aluminum conductors using single input wire (SIW) or compact round concentric-lay-stranded aluminum conductors.

(2) The ampacity ratings are based on Table 4 of the 2015 Canadian Electric Code (C22.1) (75°C conductor temperature, 30°C ambient). Ampacity ratings may be used for single circuit applications of cables directly buried, in buried duct, in duct bank, or in conduit.

Dimensions and weights not designated minimum or maximum are nominal values and subject to manufacturing tolerances. In this context, weight means mass.

Features and Benefits:

USEI-75 cables are suitable for direct burial or installed in ducts and are resistant to cut-through and sunlight. The cable is rated 600 V phase to phase, with a maximum conductor operating temperature of 75°C in wet or dry locations.

Applications:

CSA USEI-75 cable is intended for use in underground systems operating at 600 V or less. The cables are intended for underground installation, either directly buried or in duct systems, in accordance with the CEC (CSA C22.1) and CSA C22.3 No. 7 Underground Systems. Portions of the cable may be exposed to sunlight on termination poles and during storage.

Options:

- Class B stranded H16 compact ACM (series 8000) type aluminum alloy conductors
- Class B stranded compact copper conductors
- CSA C68.7 for distribution utilities

For more information, contact your General Cable sales representative or e-mail infoca@generalcable.com.



PowrServ® XL Underground Secondary Cable Type USEI-90

600 V, Aluminum Conductor, XLPE Insulation, PVC Jacket

Product Construction:

Complete Cable:

USEI-90 Underground Service Entrance Cable consists of two, three, or four compact aluminum conductors individually insulated with black RW90 XLPE insulation, a coloured PVC jacket, and twisted together. The neutral conductor will be white. The product is CSA Certified and meets the USEI-90 cable requirements of CSA C22.2 No. 52.

Conductors:

The aluminum stranded conductors are Class B compact 1350 aluminum.

Insulation:

The insulation is a sunlight-resistant, black Linear Low Density Polyethylene (LLDPE) meeting the requirements of CSA C22.2 No. 38 for Type RW90 insulation.

Jacket:

A continuous layer of PVC is extruded over the insulation. The jacket is a weather- and sunlight-resistant, non-sulphide-staining, cut-through-resistant, 90°C/-40°C FT1-rated material.

Neutral Conductor:

One of the insulated conductors is identified as a neutral conductor by the use of a white coloured PVC jacket. The neutral conductor may be the same size as the power conductor, or it may be reduced.

Phase Identification:

Phase identification is provided by means of jacket colour coding. Three conductor cable consists of a red and a black coloured power conductor and a white coloured neutral. Four conductor cable consists of a red, black, and blue coloured phase conductor and a white coloured neutral. All cables provided with sequential print marking.

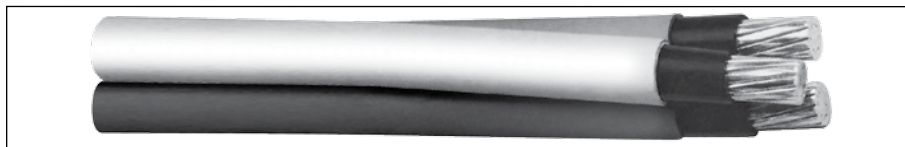

THREE CONDUCTOR TYPE USEI-90 - XLPE/PVC - 600 VOLTS

PHASE CONDUCTORS				FULL NEUTRAL CONDUCTOR				OVERALL		
SIZE (AWG OR kcmil)	NO. OF WIRES (1)	INS. THKN. (mm)	JACKET THKN. (mm)	SIZE (AWG OR kcmil)	NO. OF WIRES (1)	INS. THKN. (mm)	JACKET THKN. (mm)	EFFECTIVE DIAMETER (mm)	APPROX. WEIGHT (kg/km)	AMPACITY (2)
4	7	1.14	0.76	4	7	1.14	0.76	20	324	75
2	7	1.14	0.76	2	7	1.14	0.76	23	458	100
1	19	1.40	1.14	1	19	1.40	1.14	27	628	115
1/0	19	1.40	1.14	1/0	19	1.40	1.14	29	746	135
2/0	19	1.40	1.14	2/0	19	1.40	1.14	32	891	150
3/0	19	1.40	1.14	3/0	19	1.40	1.14	34	1068	175
4/0	19	1.40	1.14	4/0	19	1.40	1.14	37	1290	205
250	37	1.65	1.65	250	37	1.65	1.65	43	1628	230
350	37	1.65	1.65	350	37	1.65	1.65	48	2135	280
500	37	1.65	1.65	500	37	1.65	1.65	55	2871	350

REDUCED NEUTRAL CONDUCTOR

PHASE CONDUCTORS				REDUCED NEUTRAL CONDUCTOR				OVERALL		
SIZE (AWG OR kcmil)	NO. OF WIRES (1)	INS. THKN. (mm)	JACKET THKN. (mm)	SIZE (AWG OR kcmil)	NO. OF WIRES (1)	INS. THKN. (mm)	JACKET THKN. (mm)	EFFECTIVE DIAMETER (mm)	APPROX. WEIGHT (kg/km)	AMPACITY (2)
4	7	1.14	0.76	6	7	1.14	0.76	19	295	75
2	7	1.14	0.76	4	7	1.14	0.76	22	413	100
1	19	1.40	1.14	3	7	1.14	0.76	27	560	115
1/0	19	1.40	1.14	2	7	1.14	0.76	28	650	135
2/0	19	1.40	1.14	1	19	1.40	1.14	31	803	150
3/0	19	1.40	1.14	1/0	19	1.40	1.14	33	961	175
4/0	19	1.40	1.14	2/0	19	1.40	1.14	36	1157	205
250	37	1.65	1.65	3/0	19	1.40	1.14	41	1450	230
350	37	1.65	1.65	250	37	1.65	1.65	47	1966	280
500	37	1.65	1.65	350	37	1.65	1.65	53	2626	350

(1) Actual number of wires may differ for compact round stranded aluminum conductors using single input wire (SIW) or compact round concentric-lay-stranded aluminum conductors.

(2) The ampacity ratings are based on Table 4 of the 2015 Canadian Electric Code (C22.1) (90°C conductor temperature, 30°C ambient). Ampacity ratings may be used for single circuit applications of cables directly buried, in buried duct, in duct bank, or in conduit.

Dimensions and weights not designated minimum or maximum are nominal values and subject to manufacturing tolerances. In this context, weight means mass.

PowrServ® XL Underground Secondary Cable Type USEI-90

600 V, Aluminum Conductor, XLPE Insulation, PVC Jacket

FOUR CONDUCTOR TYPE USEI-90 – XLPE/PVC – 600 VOLTS										
PHASE CONDUCTORS				FULL NEUTRAL CONDUCTOR				OVERALL		
SIZE (AWG OR kcmil)	NO. OF WIRES (1)	INS. THKN. (mm)	JACKET THKN. (mm)	SIZE (AWG OR kcmil)	NO. OF WIRES (1)	INS. THKN. (mm)	JACKET THKN. (mm)	EFFECTIVE DIAMETER (mm)	APPROX. WEIGHT (kg/km)	AMPACITY (2)
4	7	1.14	0.76	4	7	1.14	0.76	22	432	75
2	7	1.14	0.76	2	7	1.14	0.76	26	611	100
1	19	1.40	1.14	1	19	1.40	1.14	31	837	115
1/0	19	1.40	1.14	1/0	19	1.40	1.14	33	995	135
2/0	19	1.40	1.14	2/0	19	1.40	1.14	35	1188	150
3/0	19	1.40	1.14	3/0	19	1.40	1.14	38	1425	175
4/0	19	1.40	1.14	4/0	19	1.40	1.14	42	1720	205
250	37	1.65	1.65	250	37	1.65	1.65	48	2170	230
350	37	1.65	1.65	350	37	1.65	1.65	54	2847	280
500	37	1.65	1.65	500	37	1.65	1.65	61	3828	350

PHASE CONDUCTORS				REDUCED NEUTRAL CONDUCTOR				OVERALL		
SIZE (AWG OR kcmil)	NO. OF WIRES (1)	INS. THKN. (mm)	JACKET THKN. (mm)	SIZE (AWG OR kcmil)	NO. OF WIRES (1)	INS. THKN. (mm)	JACKET THKN. (mm)	EFFECTIVE DIAMETER (mm)	APPROX. WEIGHT (kg/km)	AMPACITY (2)
4	7	1.14	0.76	6	7	1.14	0.76	22	403	75
2	7	1.14	0.76	4	7	1.14	0.76	25	566	100
1	19	1.40	1.14	3	7	1.14	0.76	31	770	115
1/0	19	1.40	1.14	2	7	1.14	0.76	31	899	135
2/0	19	1.40	1.14	1	19	1.40	1.14	34	1100	150
3/0	19	1.40	1.14	1/0	19	1.40	1.14	37	1317	175
4/0	19	1.40	1.14	2/0	19	1.40	1.14	40	1587	205
250	37	1.65	1.65	3/0	19	1.40	1.14	46	1984	230
350	37	1.65	1.65	250	37	1.65	1.65	52	2678	280
500	37	1.65	1.65	350	37	1.65	1.65	59	3582	350

(1) Actual number of wires may differ for compact round stranded aluminum conductors using single input wire (SIW) or compact round concentric-lay-stranded aluminum conductors.
 (2) The ampacity ratings are based on Table 4 of the 2015 Canadian Electric Code (C22.1) (90°C conductor temperature, 30°C ambient). Ampacity ratings may be used for single circuit applications of cables directly buried, in buried duct, in duct bank, or in conduit.

Dimensions and weights not designated minimum or maximum are nominal values and subject to manufacturing tolerances. In this context, weight means mass.

Features and Benefits:

The USEI-90 cables are suitable for direct burial or installed in ducts and are resistant to cut-through and sunlight. The cable is rated 600 V phase to phase, with a maximum conductor operating temperature of 90°C in wet or dry locations.

Applications:

CSA USEI-90 cable is intended for use in underground systems operating at 600 V or less. The cables are intended for underground installation, either directly buried or in duct systems, in accordance with the CEC (CSA C22.1) and CSA C22.3 No. 7 Underground Systems. Portions of the cable may be exposed to sunlight on termination poles and during storage.

Options:

- Class B stranded H16 compact ACM (series 8000) type aluminum alloy conductors
- Class B stranded compact copper conductors
- Two conductor USEI-90 cables
- CSA C68.7 for distribution utilities

For more information, contact your General Cable sales representative or e-mail infoca@generalcable.com.



PowrServ® XL Underground Secondary Cable Type USEB-90

600 V, Aluminum Conductor, XLPE Insulation, Overall PVC Jacket

Product Construction:

Complete Cable:

USEB-90 Underground Service Entrance Cable consists of two compact aluminum conductors individually insulated with RW90 XLPE insulation, laid in parallel, with a helical plain copper wire serving and an overall PVC jacket covering. The copper wire serving is the neutral. The product is CSA Certified and meets the USEB-90 cable requirements of CSA C22.2 No. 52.

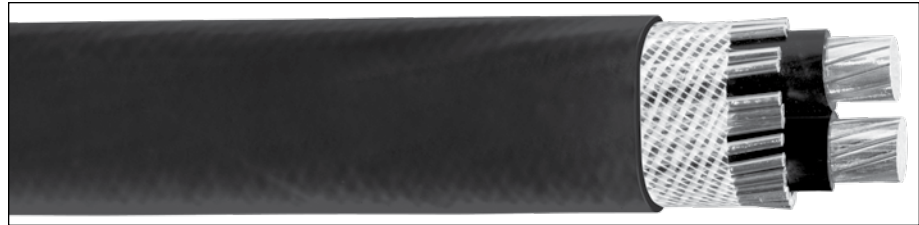

Conductors:

The aluminum stranded conductors are Class B compact 1350 aluminum.

Insulation:

The insulation is a sunlight-resistant, black Linear Low Density Polyethylene (LLDPE) meeting the requirements of CSA C22.2 No. 38 for Type RW90 insulation.

Neutral Conductor:

An annealed, plain copper wire serving is applied over top of the two power conductors. The neutral conductor may be equal to the equivalent copper AWG size of the power conductor, or it may be reduced.

Binder/Separator Tape:

A separator tape is applied overtop the helically applied neutral conductor wires.

Jacket:

Black PVC jacket is extruded over top of the cable assembly. The jacket is a weather-resistant, sunlight-resistant, 60°C/-40°C FT1-rated material.

Phase Identification:

Both of the XLPE insulated power conductors are black. One conductor will have a white coloured print legend on the surface of the insulation. The print legend includes the required CSA markings and General Cable manufacturing plant code, year marking, and "1-ONE-1" printed phase identifier. The other conductor will only have the "2-TWO-2" marking. All cables provided with sequential print marking.

TWO CONDUCTOR TYPE USEB-90 – XLPE/PVC – FULL NEUTRAL – 600 VOLTS								
PHASE CONDUCTORS				FULL NEUTRAL CONDUCTOR		OVERALL		
SIZE (AWG OR kcmil)	NO. OF WIRES (1)	INS. THKN. (mm)	JACKET THKN. (mm)	NO. OF WIRES x SIZE (AWG)	EQUIVALENT AWG SIZE	EFFECTIVE DIAMETER THKN. X WIDTH (mm)	APPROX. WEIGHT (kg/km)	AMPACITY (2)
4	7	1.14	2.03	11 x #16	6	15 x 22	456	75
2	7	1.14	2.03	17 x #16	4	16 x 25	632	100
1	19	1.40	2.03	21 x #16	3	17 x 28	770	115
1/0	19	1.40	2.03	26 x #16	2	18 x 30	916	135
2/0	19	1.40	2.03	33 x #16	1	19 x 32	1105	150
3/0	19	1.40	2.03	26 x #14	1/0	21 x 35	1340	175
4/0	19	1.40	2.03	33 x #14	2/0	22 x 37	1633	205
250	37	1.65	2.03	26 x #12	3/0	25 x 41	1969	230
300	37	1.65	2.79	21 x #10	300	30 x 47	2520	260
350	37	1.65	2.79	25 x #10	250	30 x 49	2985	280
500	37	1.65	2.79	34 x #10	350	33 x 55	3843	350

(1) Actual number of wires may differ for compact round stranded aluminum conductors using single input wire (SIW) or compact round concentric-lay-stranded aluminum conductors.

(2) The ampacity ratings are based on Table 4 of the 2015 Canadian Electric Code (C22.1) (90°C conductor temperature, 30°C ambient). Ampacity ratings may be used for single circuit applications of cables directly buried, in buried duct, in duct bank, or in conduit.

Dimensions and weights not designated minimum or maximum are nominal values and subject to manufacturing tolerances. In this context, weight means mass.

PowrServ® XL Underground Secondary Cable Type USEB-90

600 V, Aluminum Conductor, XLPE Insulation, Overall PVC Jacket

TWO CONDUCTOR TYPE USEB-90 – XLPE/PVC – REDUCED NEUTRAL – 600 VOLTS								
PHASE CONDUCTORS				REDUCED NEUTRAL CONDUCTOR		OVERALL		
SIZE (AWG OR kcmil)	NO. OF WIRES (1)	INS. THKN. (mm)	JACKET THKN. (mm)	NO. OF WIRES x SIZE (AWG)	EQUIVALENT AWG SIZE	EFFECTIVE DIAMETER THKN. x WIDTH (mm)	APPROX. WEIGHT (kg/km)	AMPACITY (2)
4	7	1.14	2.03	7 x #16	8	15 x 22	405	75
2	7	1.14	2.03	11 x #16	6	16 x 25	557	100
1	19	1.40	2.03	13 x #16	5	17 x 28	670	115
1/0	19	1.40	2.03	17 x #16	4	18 x 30	804	135
2/0	19	1.40	2.03	21 x #16	3	19 x 32	956	150
3/0	19	1.40	2.03	26 x #16	2	20 x 34	1143	175
4/0	19	1.40	2.03	21 x #14	1	24 x 39	1366	205
250	37	1.65	2.03	26 x #14	1/0	24 x 40	1651	230
300	37	1.65	2.79	21 x #12	4/0	29 x 46	2090	260
350	37	1.65	2.79	26 x #12	3/0	29 x 48	2436	280
500	37	1.65	2.79	25 x #10	250	33 x 55	3392	350

(1) Actual number of wires may differ for compact round stranded aluminum conductors using single input wire (SIW) or compact round concentric-lay-stranded aluminum conductors.

(2) The ampacity ratings are based on Table 4 of the 2015 Canadian Electric Code (C22.1) (90°C conductor temperature, 30°C ambient). Ampacity ratings may be used for single circuit applications of cables directly buried, in buried duct, in duct bank, or in conduit.

Dimensions and weights not designated minimum or maximum are nominal values and subject to manufacturing tolerances. In this context, weight means mass.

Features and Benefits:

The USEB-90 cables are suitable for direct burial or installed in ducts. The cable is rated 600 V phase to phase, with a maximum conductor operating temperature of 90°C in wet or dry locations.

Applications:

CSA USEB-90 cable is intended for use in underground systems operating at 600 V or less. The cables are intended for underground installation, either directly buried or in duct systems, in accordance with the CEC (CSA C22.1) and CSA C22.3 No. 7 Underground Systems. Portions of the cable may be exposed to sunlight on termination poles and during storage.

Options:

- Class B stranded H16 compact ACM (series 8000) type aluminum alloy conductors
- Class B stranded compact copper conductors
- CSA C68.7 for distribution utilities

For more information, contact your General Cable sales representative or e-mail infoca@generalcable.com.



PowrServ® OH Duplex Neutral-Supported Cable Type NS75

600 V, Aluminum Conductor, LLDPE Insulation, ACSR Neutral

Product Construction:

Complete Cable:

Duplex NS75 Service Drop Cable consists of one compact aluminum conductor insulated with Linear Low-Density Polyethylene (LLDPE), twisted around a bare compact ACSR stranded neutral conductor, which serves as a supporting neutral.

Triplex NS75 consists of two insulated conductors around a bare neutral.

Quadruplex NS75 consists of three insulated conductors around a bare neutral.

NS75 Service Drop Cable is CSA Certified and meets the requirements of CSA C22.2 No. 129 and CAN/CSA C61089 standards, as applicable.

Insulated Conductors:

The all-aluminum stranded conductors are Class A smooth body compact 1350-H19 (full hard) aluminum.

Insulation:

The standard product is a black, sunlight-resistant, -40°C rated Linear Low-Density Polyethylene (LLDPE).

Bare Neutral:

The Aluminum Conductor Steel Reinforced (ACSR) stranded neutral conductors are Class A smooth body compact stranded. The direction of lay of the outer layer is right-hand. ACSR neutral conductors 266.8 kcmil and larger are concentric round conductors per CAN/CSA C61089.

Phase Identification:

Phase identification is provided by means of white print legend markings on one of the black coloured phase conductors and three longitudinal red stripes on the second black coloured phase conductor. Quadruplex cables would be provided with three blue stripes on the third black coloured phase conductor. All cables provided with sequential print marking.

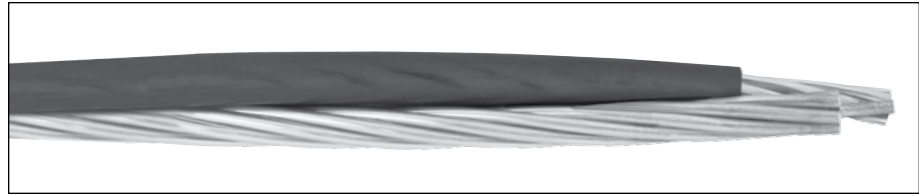

DUPLEX TYPE NS75 – LLDPE – ACSR FULL SIZE NEUTRAL – 600 VOLTS												
PHASE CONDUCTOR					ACSR COMPACT BARE NEUTRAL				OVERALL			
SIZE (AWG)	NO. OF WIRES	COND. O.D. (mm)	MIN. INS. THKN. (mm)	NOM. INS. O.D. (mm)	SIZE (AWG)	NO. OF WIRES (A1/S1A)	RATED STRENGTH kN (1)	COND. O.D. (mm)	EFFECTIVE O.D. (mm)	APPROX. WEIGHT (kg/km)	AMPACITY (2)	
6	7	4.29	1.04	6.63	6	6/1	5.18	5.0	12	111	80	
4	7	5.41	1.04	7.75	4	6/1	8.14	6.4	14	169	105	
2	7	6.88	1.04	9.14	2	6/1	12.4	8.1	17	260	140	
1/0	7	8.53	1.37	11.6	1/0	6/1	18.9	10.1	22	412	185	

(1) Rated strengths are based on CAN/CSA C49.2 standard calculation method.

(2) Ampacity rating is per 2015 CEC Table 36A, at 30°C ambient, with sun-radiated heat energy of 1025 W/m², a wind speed of 0.6 m/s, and maximum conductor temperature of 75°C.

Dimensions and weights not designated minimum or maximum are nominal values and subject to manufacturing tolerances. In this context, weight means mass.

PowrServ® OH Triplex Neutral-Supported Cable Type NS75

600 V, Aluminum Conductor, LLDPE Insulation, ACSR Neutral



Features and Benefits:

The insulated conductors of NS75 Service Drop cables are resistant to weathering, sunlight, abrasion, tearing, cutting and chemicals. The cable is rated 600 V with a maximum conductor operating temperature of 75°C for polyethylene insulation.

Applications:

Duplex and Triplex NS75 Service Drop Cable is intended to deliver single phase power from the secondary overhead power line or pole-mounted transformer to the service entrance conductors at the user's building or other structure.

Quadruplex NS75 Service Drop Cable is intended to deliver three phase power from the secondary overhead power line or pole-mounted transformers to the service entrance conductors at the user's building or other structure.

NS75 cable may also be used as pole line secondary with service splices at the pole (also refer to CEC rule 12-318).

NS75 cable is rated for use on systems having nominal voltages of 600 V or less.

Options:

- Reduced-size insulated conductor for use as a water heater control conductor
- Colour-coded PVC jackets which are used for phase identification and FT1-rated for flame retardancy
- Alternate phase identification by the use of printed numbers on the black coloured insulation
- Neutral conductor corrosion-resistant inhibitor treatment
- Neutral supported cable is available with annealed copper conductors
- Concentric stranded Class A, 6101-T81 aluminum alloy stranded neutral messenger conductor (A2)
- Concentric stranded Class A, 6101-T81 aluminum alloy – high strength steel-reinforced stranded neutral messenger conductor (A2/S3A, AACSR)
- CSA C68.8 for distribution utilities

For more information, contact your General Cable sales representative or e-mail infoca@generalcable.com.

TRIPLEX TYPE NS75 – LLDPE – ACSR FULL SIZE NEUTRAL – 600 VOLTS											
PHASE CONDUCTORS					ACSR COMPACT BARE NEUTRAL (4)				OVERALL		
SIZE (AWG OR kcmil)	NO. OF WIRES (1)	COND. O.D. (mm)	MIN. INS. THKN. (mm)	NOM. INS. O.D. (mm)	SIZE (AWG OR kcmil)	NO. OF WIRES (A1/S1A)	RATED STRENGTH kN (2)	COND. O.D. (mm)	EFFECTIVE O.D. (mm)	APPROX. WEIGHT (kg/km)	AMPACITY (3)
6	7	4.29	1.04	6.63	6	6/1	5.18	5.03	13	167	80
4	7	5.41	1.04	7.75	4	6/1	8.14	6.35	16	252	105
2	7	6.88	1.04	9.14	2	6/1	12.4	8.11	19	383	140
1/0	7	8.53	1.37	11.6	1/0	6/1	18.9	10.1	24	601	185
2/0	7	9.65	1.37	12.6	2/0	6/1	23.5	11.5	27	751	210
3/0	7	10.7	1.37	13.8	3/0	6/1	29.6	12.8	29	931	245
4/0	7	12.1	1.37	15.2	4/0	6/1	37.3	14.3	32	1157	280
266.8	19	13.6	1.83	17.7	266.8	26/7	50.1	16.3	38	1486	325
336.4	19	15.3	1.83	19.4	336.4	26/7	62.3	18.3	42	1844	375
397.5	19	16.7	1.83	20.8	397.5	26/7	71.6	19.9	45	2157	415
477	19	18.3	1.83	22.4	477	26/7	86.0	21.8	49	2565	460

TRIPLEX TYPE NS75 – LLDPE – ACSR REDUCED SIZE NEUTRAL – 600 VOLTS											
PHASE CONDUCTORS					ACSR COMPACT BARE NEUTRAL (4)				OVERALL		
SIZE (AWG OR kcmil)	NO. OF WIRES (1)	COND. O.D. (mm)	MIN. INS. THKN. (mm)	NOM. INS. O.D. (mm)	SIZE (AWG OR kcmil)	NO. OF WIRES (A1/S1A)	RATED STRENGTH kN (2)	COND. O.D. (mm)	EFFECTIVE O.D. (mm)	APPROX. WEIGHT (kg/km)	AMPACITY (3)
4	7	5.41	1.04	7.75	6	6/1	5.18	5.03	15	220	105
2	7	6.88	1.04	9.14	4	6/1	8.14	6.35	18	333	140
1/0	7	8.53	1.37	11.6	2	6/1	12.4	8.11	23	527	185
2/0	7	9.65	1.37	12.6	1	6/1	15.5	8.99	25	650	210
3/0	7	10.7	1.37	13.8	1/0	6/1	18.9	10.1	28	803	245
4/0	7	12.1	1.37	15.2	2/0	6/1	23.5	11.5	30	996	280
266.8	19	13.6	1.83	17.7	3/0	6/1	29.6	12.8	35	1282	325
336.4	19	15.3	1.83	19.4	4/0	6/1	37.3	14.3	39	1588	375
397.5	19	16.7	1.83	20.8	266.8	26/7	50.1	16.3	42	1890	415
477	19	18.3	1.83	22.4	336.4	26/7	62.3	18.3	46	2277	460

(1) For compact stranded constructions, the number of wires may be reduced as follows:

19-Wire Constructions – 18 Wires Minimum
37-Wire Constructions – 35 Wires Minimum

(2) Rated strengths are based on CAN/CSA C49.2 and C61089 standard calculation method.

(3) Ampacity rating is per 2015 CEC Table 36A, at 30°C ambient, with sun-radiated heat energy of 1025 W/m², a wind speed of 0.6 m/s, and maximum conductor temperature of 75°C.

(4) ACSR neutral conductors 266.8 kcmil and larger are concentric round conductors per CAN/CSA C61089.

Dimensions and weights not designated minimum or maximum are nominal values and subject to manufacturing tolerances. In this context, weight means mass.



PowrServ® OH Quadruplex Neutral-Supported Cable Type NS75

600 V, Aluminum Conductor, LLDPE Insulation, ACSR Neutral



QUADRUPLEX TYPE NS75 – LLDPE – ACSR FULL SIZE NEUTRAL – 600 VOLTS											
PHASE CONDUCTORS					ACSR COMPACT BARE NEUTRAL (4)				OVERALL		
SIZE (AWG OR kcmil)	NO. OF WIRES (1)	COND. O.D. (mm)	MIN. INS. THKN. (mm)	NOM. INS. O.D. (mm)	SIZE (AWG OR kcmil)	NO. OF WIRES (A1/S1A)	RATED STRENGTH kN (2)	COND. O.D. (mm)	EFFECTIVE O.D. (mm)	APPROX. WEIGHT (kg/km)	AMPACITY (3)
6	7	4.29	1.04	6.63	6	6/1	5.18	5.03	15	224	70
4	7	5.41	1.04	7.75	4	6/1	8.14	6.35	18	335	95
2	7	6.81	1.04	9.14	2	6/1	12.4	8.11	21	507	125
1/0	7	8.53	1.37	11.6	1/0	6/1	18.9	10.1	27	803	165
2/0	7	9.65	1.37	12.6	2/0	6/1	23.5	11.5	30	991	190
3/0	7	10.7	1.37	13.8	3/0	6/1	29.6	12.8	33	1224	220
4/0	7	12.1	1.37	15.2	4/0	6/1	37.3	14.3	36	1519	255
266.8	19	13.6	1.83	17.7	266.8	26/7	50.1	16.3	42	1955	290
336.4	19	15.3	1.83	19.4	336.4	26/7	62.3	18.3	46	2421	335
397.5	19	16.7	1.83	20.8	397.5	26/7	71.6	19.9	50	2828	370
477	19	18.3	1.83	22.4	477	26/7	86.0	21.8	54	3359	415

(1) For compact stranded constructions, the number of wires may be reduced as follows:
 19-Wire Constructions – 18 Wires Minimum
 37-Wire Constructions – 35 Wires Minimum

(2) Rated strengths are based on CAN/CSA C49.2 and C61089 standard calculation method.

(3) Ampacity rating is per 2015 CEC Table 36A, at 30°C ambient, with sun-radiated heat energy of 1025 W/m², a wind speed of 0.6 m/s, and maximum conductor temperature of 75°C.

(4) ACSR neutral conductors 266.8 kcmil and larger are concentric round conductors per CAN/CSA C61089. Dimensions and weights not designated minimum or maximum are nominal values and subject to manufacturing tolerances. In this context, weight means mass.

PowrServ® OH Duplex Neutral-Supported Cable Type NS75/NS90

600 V, Aluminum Conductor, XLPE Insulation, ACSR Neutral



Product Construction:

Complete Cable:

Duplex NS75/NS90 Service Drop Cable consists of one compact aluminum conductor insulated with Cross-linked Polyethylene (XLPE), twisted around a bare compact ACSR stranded neutral conductor, which serves as a supporting neutral.

Triplex NS75/NS90 consists of two insulated conductors around a bare neutral.

Quadruplex NS75/NS90 consists of three insulated conductors around a bare neutral.

NS75/NS90 Service Drop Cable is CSA Certified and meets the requirements of CSA C22.2 No. 129 and CAN/CSA C61089 standards, as applicable.

Insulated Conductors:

The all-aluminum stranded conductors are Class A smooth body compact 1350-H19 (full hard) aluminum.

Insulation:

The standard product is a black, sunlight-resistant, -40°C rated extruded Cross-linked Polyethylene (XLPE).

Bare Neutral:

The aluminum conductor steel reinforced (ACSR) stranded neutral conductors are Class A smooth body compact stranded. The direction of lay of the outer layer is right-hand. ACSR neutral conductors 266.8 kcmil and larger are concentric round conductors per CAN/CSA C61089.

Phase Identification:

Phase identification is provided by means of white print legend markings on one of the black coloured phase conductors and three longitudinal red stripes on the second black coloured phase conductor. Quadruplex cables would be provided with three blue stripes on the third black coloured phase conductor. All cables provided with sequential print marking.

DUPLIX TYPE NS75/NS90 – XLPE – ACSR FULL SIZE NEUTRAL – 600 VOLTS												
PHASE CONDUCTORS					ACSR COMPACT BARE NEUTRAL				OVERALL			
SIZE (AWG)	NO. OF WIRES	COND. O.D. (mm)	MIN. INS. THKN. (mm)	NOM. INS. O.D. (mm)	SIZE (AWG)	NO. OF WIRES (A1/S1A)	RATED STRENGTH kN (1)	COND. O.D. (mm)	EFFECTIVE O.D. (mm)	APPROX. WEIGHT (kg/km)	AMPACITY (2)	
6	7	4.29	1.04	6.63	6	6/1	5.18	5.0	12	111	95	
4	7	5.41	1.04	7.75	4	6/1	8.14	6.4	14	169	125	
2	7	6.88	1.04	9.14	2	6/1	12.4	8.1	17	260	165	
1/0	7	8.53	1.37	11.6	1/0	6/1	18.9	10.1	22	412	220	

(1) Rated strengths are based on CAN/CSA C49.2 standard calculation method.
 (2) Ampacity rating is per 2015 CEC Table 36A, at 30°C ambient, with sun-radiated heat energy of 1025 W/m², a wind speed of 0.6 m/s, and maximum conductor temperature of 90°C.
 Dimensions and weights not designated minimum or maximum are nominal values and subject to manufacturing tolerances. In this context, weight means mass.



PowrServ® OH Triplex Neutral-Supported Cable Type NS75/NS90

600 V, Aluminum Conductor, XLPE Insulation, ACSR Neutral

Features and Benefits:

The insulated conductors of NS75/NS90 Service Drop Cables are resistant to weathering, sunlight, abrasion, tearing, cutting and chemicals. The cable is rated 600 V with a maximum conductor operating temperature of 90°C for Cross-linked Polyethylene insulation, which allows for higher ampacity compared to NS75 cable.



Applications:

Duplex and Triplex NS75/NS90 Service Drop Cable is intended to deliver single phase power from the secondary overhead power line or pole-mounted transformer to the service entrance conductors at the user's building or other structure.

Quadruplex NS75/NS90 Service Drop Cable is intended to deliver three phase power from the secondary overhead power line or pole-mounted transformers to the service entrance conductors at the user's building or other structure.

NS75/NS90 cable may also be used as pole line secondary with service splices at the pole (also refer to CEC rule 12-318).

NS75/NS90 cable is rated for use on systems having nominal voltages of 600 V or less.

Options:

- Reduced-size insulated conductor for use as a water heater control conductor
- Colour-coded PVC jackets which are used for phase identification and FT1-rated for flame retardancy
- Alternate phase identification by the use of printed numbers on the black coloured insulation
- Neutral conductor corrosion-resistant inhibitor treatment
- FT1-rated flame-retardant insulation
- Neutral-supported cable is available with annealed copper conductors
- Concentric stranded Class A, 6101-T81 aluminium alloy stranded neutral messenger conductor (A2)
- Concentric stranded Class A, 6101-T81 aluminium alloy – high strength steel-reinforced stranded neutral messenger conductor (A2/S3A, AACSR)
- CSA C68.8 for distribution utilities

For more information, contact your General Cable sales representative or e-mail infoca@generalcable.com.

TRIPLEX TYPE NS75/NS90 – XLPE – ACSR FULL SIZE NEUTRAL – 600 VOLTS											
PHASE CONDUCTORS					ACSR COMPACT BARE NEUTRAL (4)				OVERALL		
SIZE (AWG OR kcmil)	NO. OF WIRES (1)	COND. O.D. (mm)	MIN. INS. THKN. (mm)	NOM. INS. O.D. (mm)	SIZE (AWG OR kcmil)	NO. OF WIRES (A1/S1A)	RATED STRENGTH kN (2)	COND. O.D. (mm)	EFFECTIVE O.D. (mm)	APPROX. WEIGHT (kg/km)	AMPACITY (3)
6	7	4.29	1.04	6.63	6	6/1	5.18	5.03	13	167	95
4	7	5.41	1.04	7.75	4	6/1	8.14	6.35	16	252	125
2	7	6.88	1.04	9.14	2	6/1	12.4	8.11	19	383	165
1/0	7	8.53	1.37	11.6	1/0	6/1	18.9	10.1	24	601	220
2/0	7	9.65	1.37	12.6	2/0	6/1	23.5	11.5	27	751	255
3/0	7	10.7	1.37	13.8	3/0	6/1	29.6	12.8	29	931	290
4/0	7	12.1	1.37	15.2	4/0	6/1	37.3	14.3	32	1157	335
266.8	19	13.6	1.83	17.7	266.8	26/7	50.1	16.3	38	1486	390
336.4	19	15.3	1.83	19.4	336.4	26/7	62.3	18.3	42	1844	450
397.5	19	16.7	1.83	20.8	397.5	26/7	71.6	19.9	45	2157	500
477	19	18.3	1.83	22.4	477	26/7	86.0	21.8	49	2565	560

TRIPLEX TYPE NS75/NS90 – XLPE – ACSR REDUCED SIZE NEUTRAL – 600 VOLTS											
PHASE CONDUCTORS					ACSR COMPACT BARE NEUTRAL (4)				OVERALL		
SIZE (AWG OR kcmil)	NO. OF WIRES (1)	COND. O.D. (mm)	MIN. INS. THKN. (mm)	NOM. INS. O.D. (mm)	SIZE (AWG OR kcmil)	NO. OF WIRES (A1/S1A)	RATED STRENGTH kN (2)	COND. O.D. (mm)	EFFECTIVE O.D. (mm)	APPROX. WEIGHT (kg/km)	AMPACITY (3)
4	7	5.41	1.04	7.75	6	6/1	5.18	5.03	15	220	125
2	7	6.88	1.04	9.14	4	6/1	8.14	6.35	18	333	165
1/0	7	8.53	1.37	11.6	2	6/1	12.4	8.11	23	527	220
2/0	7	9.65	1.37	12.6	1	6/1	15.5	8.99	25	650	255
3/0	7	10.7	1.37	13.8	1/0	6/1	18.9	10.1	28	803	290
4/0	7	12.1	1.37	15.2	2/0	6/1	23.5	11.5	30	996	335
266.8	19	13.6	1.83	17.7	3/0	6/1	29.6	12.8	35	1282	390
336.4	19	15.3	1.83	19.4	4/0	6/1	37.3	14.3	39	1588	450
397.5	19	16.7	1.83	20.8	266.8	26/7	50.1	16.3	42	1890	500
477	19	18.3	1.83	22.4	336.4	26/7	62.3	18.3	46	2277	560

(1) For compact stranded constructions, the number of wires may be reduced as follows:
 19-Wire Constructions – 18 Wires Minimum
 37-Wire Constructions – 35 Wires Minimum

(2) Rated strengths are based on CAN/CSA C61089 standard calculation method.

(3) Ampacity rating is per 2015 CEC Table 36A, at 30°C ambient, with sun-radiated heat energy of 1025 W/m², a wind speed of 0.6 m/s, and maximum conductor temperature of 90°C.

(4) ACSR neutral conductors 266.8 kcmil and larger are concentric round conductors per CAN/CSA C61089. Dimensions and weights not designated minimum or maximum are nominal values and subject to manufacturing tolerances. In this context, weight means mass.



PowerServ® OH Quadruplex Neutral-Supported Cable Type NS75/NS90

600 V, Aluminum Conductor, XLPE Insulation, ACSR Neutral



QUADRUPLEX TYPE NS75/NS90 – XLPE – ACSR FULL SIZE NEUTRAL – 600 VOLTS

PHASE CONDUCTORS					ACSR COMPACT BARE NEUTRAL (4)				OVERALL		
SIZE (AWG OR kcmil)	NO. OF WIRES (1)	COND. O.D. (mm)	MIN. INS. THKN. (mm)	NOM. INS. O.D. (mm)	SIZE (AWG OR kcmil)	NO. OF WIRES (A1/S1A)	RATED STRENGTH kN (2)	COND. O.D. (mm)	EFFECTIVE O.D. (mm)	APPROX. WEIGHT (kg/km)	AMPACITY (3)
6	7	4.29	1.04	6.63	6	6/1	5.18	5.03	15	224	85
4	7	5.41	1.04	7.75	4	6/1	8.14	6.35	18	335	110
2	7	6.81	1.04	9.14	2	6/1	12.4	8.11	21	507	150
1/0	7	8.53	1.37	11.6	1/0	6/1	18.9	10.1	27	803	200
2/0	7	9.65	1.37	12.6	2/0	6/1	23.5	11.5	30	991	230
3/0	7	10.7	1.37	13.8	3/0	6/1	29.6	12.8	33	1224	265
4/0	7	12.1	1.37	15.2	4/0	6/1	37.3	14.3	36	1519	305
266.8	19	13.6	1.83	17.7	266.8	26/7	50.1	16.3	42	1955	355
336.4	19	15.3	1.83	19.4	336.4	26/7	62.3	18.3	46	2421	410
397.5	19	16.7	1.83	20.8	397.5	26/7	71.6	19.9	50	2828	455
477	19	18.3	1.83	22.4	477	26/7	86.0	21.8	54	3359	510

(1) For compact stranded constructions, the number of wires may be reduced as follows:
 19-Wire Constructions – 18 Wires Minimum
 37-Wire Constructions – 35 Wires Minimum

(2) Rated strengths are based on CAN/CSA C61089 standard calculation method.

(3) Ampacity rating is per 2015 CEC Table 36A, at 30°C ambient, with sun-radiated heat energy of 1025 W/m², a wind speed of 0.6 m/s, and maximum conductor temperature of 90°C.

(4) ACSR neutral conductors 266.8 kcmil and larger are concentric round conductors per CAN/CSA C61089. Dimensions and weights not designated minimum or maximum are nominal values and subject to manufacturing tolerances. In this context, weight means mass.



Medium-Voltage Power Cable

EmPowr® Underground Distribution and Shielded Power Cables

General Cable's EmPowr® underground distribution and shielded power cables are manufactured and tested in accordance with CSA C68.5 for copper concentric neutral, copper flat strap, copper wire, copper tape and longitudinally applied corrugated copper tape (LACT) shielded power cable designs for distribution utilities. Other shielded power cable designs manufactured and tested in accordance with CSA C68.10 are available. Our cables may also meet the latest requirements of AEIC CS8 as applicable.

Stranded conductors are Class B compact (4 AWG to 1000 kcmil) 3/4 to full hard 1350 aluminum. Conductors are also available in solid, class B compressed or compact concentric-lay-stranded aluminum or copper, meeting the appropriate requirements of ASTM and CSA. Stranded conductors can be blocked to prevent longitudinal penetration of water along the cable. When applicable, STRANDFILL® conductors are tested in accordance with ICEA T-31-610.

Exceptional measures are taken during the materials handling and extrusion processes to ensure our cable delivers the reliability and longevity expected by our customers. All compounds are received and handled in an ultra-clean environment. Compounds are received in specially designed ultra-clean containers (protective outer box with a sealed removable inner lining) and handled within Class 10,000 conditions. In addition to the special materials handling, the conductor shield, insulation and insulation shield are applied using triple extrusion technology. These extra measures provide our customers with the highest-quality cable products available in the industry.

Designs are manufactured with either lead-free Tree-Retardant Cross-linked Polyethylene (TRXLPE), Ethylene Propylene Rubber (EPR) or lead-free EAM insulation. Our EmPowr® Link TRXLPE insulated cables offer high dielectric strength with extremely low dielectric loss characteristics. TRXLPE insulation is an economical option for the high-volume usage in underground residential systems. Our EmPowr® Fill EPR insulated cables are flexible for easy handling and exhibit excellent heat and moisture resistance. The physical and thermal characteristics of EPR insulation result in a high resistance to deformation. EPR insulation is typically specified for heavily loaded circuits such as feeders and network systems.

Cables are available with various metallic shields that include round wires (16 AWG or larger), helically applied copper tape, flat copper straps or longitudinally applied corrugated copper tape. Combinations of water-swellable tapes and powders applied between the insulation shield and jacket provide maximum moisture migration protection. When applicable, BIFILL® water-blocked cables are tested in accordance with ICEA T-34-664.

Standard designs are manufactured with black, non-conducting, sunlight-resistant Linear Low-Density Polyethylene (LLDPE). Jacketed cables are rated for 90°C maximum conductor temperature under normal conditions. General Cable's EmPowr® Link CL™ TRXLPE insulated XLPE jacketed cables allow reduced-size copper concentric neutrals while still providing fault current of an LLDPE jacket, leading to cooler operation and lower line losses. EmPowr® Link CL™ maintains the same physical properties of EmPowr® Link LLDPE jacket constructions but with enhanced thermomechanical performance providing excellent resistance to deformation. EmPowr® Link CL™ meets the latest requirements of CSA C68.5 and AEIC CS8 as applicable for TRXLPE. EmPowr® Link CL™ is rated for 105°C maximum conductor temperature under normal conditions in accordance with CSA C68.5. This design option has been particularly successful for renewable energy collection systems.

A growing alternative to direct buried cable or pulling cable in rigid conduit is purchasing cable pre-installed in flexible duct. Our Combined Duct & Cable offers mechanical protection comparable to rigid polyethylene duct and saves the labor of pulling cable into rigid duct. Combined Duct and Cable can also save considerable costs associated with cable replacement as compared to direct buried cable installations.

General Cable provides a number of underground cables designed to meet special applications. For example, our PowrPak® cables are intended for use in today's aging and expanding urban underground distribution systems of utilities where PILC has been used previously. Our unique PowrPak® design and special manufacturing techniques allow a diameter reduction of more than 15 percent relative to standard CSA solid dielectric cables. The smaller diameter permits PowrPak® to be installed into existing ductwork, which is not always possible with other types of PILC replacement cable.

While General Cable manufactures a complete range of primary concentric neutral power cables, only the most popular designs are described in the following section. Details of other constructions and sizes are available upon request.

General Cable provides technical assistance and advice on any challenges associated with cable design, installation, or application. Engineering services are available for specification review, specification development, and cable application inquiries. For further information, contact your nearest General Cable sales representative or e-mail infoca@generalcable.com.

Medium-Voltage Options:

- **STRANDFILL®** – Limits the ingress of water into the conductor during cable manufacture, storage, installation and after service failure.
- **BIFILL®** – Limits the ingress of water into the conductor and underneath the outer cable jacket during cable manufacture, storage, installation and after service failure.
- **EPR Type III 105°C rating** – Allows a slightly higher ampacity of the cable for a given installation condition.
- **TRXLPE Type III 105°C rating** – Allows a slightly higher ampacity of the cable for a given installation condition.
- **Dry cure for EPR insulated cables** – More of a preference.
- **TRXLPE 100% pellet inspection** – 100% new generation optical pellet inspection of TRXLPE insulation. The optical pellet inspection systems are dual pass units. Insulation pellets are inspected twice, utilizing a dual array of high resolution cameras for detection and a dual array of high speed air ejectors for rejection of contaminants.
- **Flat strap neutrals** – Reduce the overall cable diameter and can provide more protective coverage over the extruded cable core.
- **Red stripes** – Used for identifying medium-voltage power cables.
- **Semiconducting jackets** – Provide an electrical connection with the earth in direct burial applications, which allows a reduction of ground rods per mile in accordance with the CEC.
- **PVC jacket** – PVC can provide a flame-retardant cable design but is susceptible to degradation by some hydrocarbons, ketones, esters, and chlorinated hydrocarbons. This option should not be applied in applications where these materials can come in contact with the cable jacket. PVC cable jackets require a separator tape under the jacket to protect the extruded semiconducting insulation shield from plasticizers.
- **Deformation-resistant Polypropylene (PP)** – Used in applications requiring an outer jacket that is more deformation-resistant at higher temperatures and/or provides better mechanical protection during installation.
- **CL™ Jacket** – Allows reduced-size copper concentric neutrals while still providing the fault current of an LLDPE jacket, leading to cooler operation and lower line losses.
- **CL™ Advantage** – Further enhances the CL™ cable design by incorporating a flat strap neutral in place of traditional round neutral wires.
- **Combined Duct & Cable** – Used for applications where future cable replacement is anticipated and access to the cable is prohibited. Combined Duct and Cable can also help protect the cable during direct burial installation.
- **Dual Rated UL Type MV-90 or MV-105** – Used in applications where UL Listed cable is required for NEC installations.
- **UltraPowr®** – A super-smooth and extra-clean thermoset conductor shield compound that provides a smoother interface with the insulation. This type of conductor shield is only used with TRXLPE insulated cables.
- **Low strip insulation shield (TRXLPE only)** – An easier-stripping insulation shield, with adhesion to the insulation in the 3-10 lb range at room temperature.
- **Triplexed or paralleled** – Provides the user with all three phases on one reel for easier installation set-up.
- **Three conductor cable with an overall jacket** – More of a preference.
- **Class C stranded copper conductor** – Provides a more flexible conductor than the standard Class B stranding.
- **Reduced insulation wall** – A reduced wall insulation thickness is only recommended when a compact conductor, reduced extruded shield thickness, flat strap neutral and reduced outer jacket thickness have not reduced the overall cable diameter enough for adequate duct clearance during installation. Mainly used for replacement of PILC cables.

Index	Page
Concentric Neutral Underground Distribution	
15 – 46 kV TRXLPE Insulation	17-26
Flat Strap – PILC Replacement	
15 – 25 kV EPR Insulation	33-34
Copper Tape Shielded Power	
5 – 46 kV TRXLPE Insulation	35-38
Longitudinally Applied Corrugated Tape (LACT) Shielded Power	
15 – 35 kV TRXLPE Insulation	39-42



Medium-Voltage Power Cable

Insulation Level Definitions

Several years ago, the terms used to identify the insulation thickness of medium-voltage cable for the various voltage ratings were “Grounded” and “Ungrounded”. These terms led the electrical industry to a common but erroneous belief that the type of system grounding determined the insulation level required. The terms were later replaced in the cable standards with “100% insulation level” and “133% insulation level” respectively, which are selected based on the “ground fault protection” of the system. The longer the fault remains on an electrical system, the longer the cable is electrically stressed. An effective way of minimizing the stress is by increasing the insulation thickness to the next level (e.g., 100% to 133%). The relationship of “ground fault protection” to the “insulation level” is best remembered as follows:

- 100% insulation level for fault clearing within one minute
- 133% insulation level for fault clearing between one minute and one hour
- 173% insulation level for indefinite periods

Voltage Rating

The designed, continuous operation, line to line (phase to phase) voltage rating for power cables is printed on the surface of the cable jacket. Rating examples are: 15 kV, 25 kV, 35 kV, etc. During conditions when the actual applied line voltage exceeds the cable rated voltage, General Cable's power cable products, in accordance with industry standards, are designed to withstand a continuous overvoltage of up to 5% during normal operation and up to 10% during contingency conditions lasting no longer than 15 minutes.

EmPowr® Link Underground Distribution Cable 15-46 kV

Copper Conductor TRXLPE Insulation Concentric Neutral LLDPE Jacket

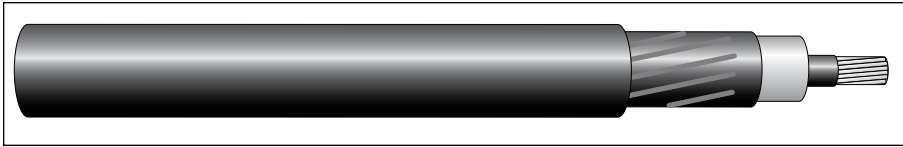

COPPER UNDERGROUND DISTRIBUTION CABLE - 15 kV - TYPE URD - FULL NEUTRAL													
COMPACT CONDUCTOR		COPPER NEUTRAL		DIAMETER (2) (mm)				NOM. JACKET THKN. (2) (mm)	APPROX. WEIGHT (kg/km)			AMPACITY (3)	
SIZE (AWG OR kcmil)	NO. OF WIRES (1)	NO. OF WIRES	WIRE SIZE (AWG)	INS.	INS. SHIELD	NEUT. WIRES	ENCAP LLDPE JACKET		CU COND.	CU NEUT. WIRES	TOTAL	DIRECT BURIED	IN DUCT
4.45 mm (175 mils) NOMINAL TRXLPE INSULATION - 100% INSULATION LEVEL													
2	7	16	14	16.6	18.4	21.3	24.1	1.4	305	317	996	240	175
1	19	20	14	17.4	19.2	22.1	24.9	1.4	385	396	1166	275	200
1/0	19	26	14	18.3	20.1	23.1	25.9	1.4	485	515	1398	315	225
2/0	19	20	12	19.4	21.1	24.9	27.7	1.4	612	628	1688	360	255
3/0	19	26	12	20.5	22.3	26.1	28.9	1.4	771	817	2050	410	295
4/0	19	32	12	21.9	23.6	27.5	30.3	1.4	972	1006	2457	465	330

COPPER UNDERGROUND DISTRIBUTION CABLE - 15 kV - TYPE UD - 1/3 NEUTRAL													
COMPACT CONDUCTOR		COPPER NEUTRAL		DIAMETER (2) (mm)				NOM. JACKET THKN. (2) (mm)	APPROX. WEIGHT (kg/km)			AMPACITY (4)	
SIZE (AWG OR kcmil)	NO. OF WIRES (1)	NO. OF WIRES	WIRE SIZE (AWG)	INS.	INS. SHIELD	NEUT. WIRES	ENCAP LLDPE JACKET		CU COND.	CU NEUT. WIRES	TOTAL	DIRECT BURIED	IN DUCT
4.45 mm (175 mils) NOMINAL TRXLPE INSULATION - 100% INSULATION LEVEL													
2	7	9	16	16.6	18.4	20.7	23.5	1.4	305	112	790	230	200
1	19	11	16	17.4	19.2	21.5	24.3	1.4	385	137	910	265	225
1/0	19	9	14	18.3	20.1	23.1	25.9	1.4	485	178	1096	300	255
2/0	19	11	14	19.4	21.1	24.1	26.9	1.4	612	218	1286	340	290
3/0	19	14	14	20.5	22.3	25.3	28.1	1.4	771	278	1531	385	325
4/0	19	18	14	21.9	23.6	26.6	29.4	1.4	972	357	1839	435	360
250	37	21	14	23.2	25.0	27.9	30.7	1.4	1149	417	2106	475	385
350	37	18	12	25.7	27.4	31.2	34.0	1.4	1609	566	2808	555	440
500	37	26	12	28.7	31.0	34.8	37.6	1.4	2298	818	3842	635	485
750	61	25	10	33.3	35.6	40.4	44.5	2.0	3447	1250	5666	710	540
1000	61	32	10	37.1	39.4	44.3	48.4	2.0	4596	1601	7257	760	585

(1) For compact stranded constructions, the number of wires may be reduced as follows:
 19-Wire Constructions - 18 Wires Minimum
 37-Wire Constructions - 35 Wires Minimum
 61-Wire Constructions - 58 Wires Minimum

(2) Extruded layer thicknesses are in accordance with CSA C68.5 for Primary Shielded and Concentric Neutral Cable for Distribution Utilities.

(3) Ampacities based on earth thermal resistivity of 90°C-cm/watt, 90°C conductor temperature, 20°C earth ambient temperature, 75% load factor, and 36" depth of burial. Values based on single phase operation, with full current return in the neutral wires. Ducts sized for 40% fill. For specific ampacities, contact your General Cable sales representative.

(4) Ampacities based on earth thermal resistivity of 90°C-cm/watt, 90°C conductor temperature, 20°C earth ambient temperature, 75% load factor, and 36" depth of burial. Values based on one three phase circuit, one conductor per phase, in flat adjacent configuration with neutral wires bonded at each end. Ducts sized for 40% fill. For specific ampacities, contact your General Cable sales representative.

Dimensions and weights not designated minimum or maximum are nominal values and subject to manufacturing tolerances. In this context, weight means mass.

Product Construction:

Complete Cable:

Cross-linked semi-conducting conductor shield, insulation and semi-conducting insulation shield are extruded over a solid or stranded aluminum or copper conductor and cured in a single operation. Uncoated copper neutral wires (helicly applied) and extruded-to-fill black jacket are applied over the cable core.

Conductor:

Class B concentric lay stranded compact annealed uncoated copper or compact 3/4 to full hard 1350 aluminum (all sizes). The stranded conductors are longitudinally water blocked (STRANDFILL®) and tested in accordance with ICEA T-31-610.

Conductor Shield:

Extruded semi-conducting thermosetting polymeric stress control layer.

Insulation:

Extruded, unfilled Tree Retardant Cross-linked Polyethylene (TRXLPE) as defined in CSA C68.5.

Insulation Shield:

Extruded semi-conducting thermosetting layer, clean and free stripping from insulation.

Metallic Shield:

Helicly applied, annealed, solid bare copper wires sized in accordance with CSA C68.5.

Jacket:

Black, non-conducting, sunlight-resistant Linear Low-Density Polyethylene (LLDPE) extruded-to-fill spaces between neutral wires. Three extruded red stripes are incorporated into the cable jacket to provide visual identification of a jacketed power cable.

Features and Benefits:

- CSA C68.5 listed
- 90°C/-40°C (LTGG)
- Triple extruded for clean interfaces
- Dry nitrogen cure for enhanced performance
- Class 10,000 environment utilized for material handling
- Excellent moisture resistance
- High dielectric strength
- Low dielectric loss
- Excellent resistance to treeing
- Clean stripping insulation shield
- Sequential meter marking
- Sunlight-resistant



EmPowr® Link Underground Distribution Cable 15-46 kV

Aluminum Conductor TRXLPE Insulation Concentric Neutral LLDPE Jacket

Temperature Rating:

- Normal..... 90°C
- Emergency* 130°C
- Short Circuit..... 250°C

*Operation at the emergency overload temperature shall not exceed 1500 hours cumulative during the lifetime of the cable.

Specifications:

General Cable utility products concentric neutral power cables meet the latest requirements of CSA C68.5 as applicable for Tree Retardant Cross-linked Polyethylene (TRXLPE) insulated concentric neutral power cable.

Applications:

EmPowr® Link cables are intended for use in dry or wet locations for distribution of single or three phase medium voltage power. Cables with a full neutral are designed for use on single phase Underground Distribution (UD) applications. Cables with a 1/3rd neutral are designed for use with three phase UD applications. The Full neutral cable is sometimes referred to as an Underground Residential Distribution (URD) cable. These cables may be installed in ducts or direct buried.

Options:

- Compressed aluminum conductor
- Compressed copper conductor
- BIFILL® blocked conductor and cable core/jacket. Tested in accordance with ICEA T-34-664
- UltraPowr® smoother and cleaner semi-conducting conductor shield
- Low strip insulation shield
- Flat strap concentric neutral
- Semi-conducting thermoplastic jacket
- Overlaying PVC jacket (FT1) with separator tape
- Available with lead-free EAM insulation
- Available with EPR insulation
- Available with metric (mm²) conductor sizes
- Combined Duct & Cable
- 3 X 1/C triplex or parallel assembly
- AEIC CS8
- CL™ jacket
- 100% pellet inspection

For more information, or information on conductor sizes or voltage ratings not shown in the tables, contact your General Cable sales representative or e-mail infoca@generalcable.com.

ALUMINUM UNDERGROUND DISTRIBUTION CABLE – 15 kV – TYPE URD – FULL NEUTRAL													
COMPACT CONDUCTOR		COPPER NEUTRAL		DIAMETER (2) (mm)				NOM. JACKET THKN. (2) (mm)	APPROX. WEIGHT (kg/km)			AMPACITY (3)	
SIZE (AWG OR kcmil)	NO. OF WIRES (1)	NO. OF WIRES	WIRE SIZE (AWG)	INS.	INS. SHIELD	NEUT. WIRES	ENCAP LLDPE JACKET		AL COND.	CU NEUT. WIRES	TOTAL	DIRECT BURIED	IN DUCT

4.45 mm (175 mils) NOMINAL TRXLPE INSULATION – 100% INSULATION LEVEL

2	1	10	14	16.4	18.1	21.1	23.9	1.4	91	198	665	190	130
2	7	10	14	16.6	18.4	21.3	24.1	1.4	93	198	677	190	130
1	1	13	14	17.1	18.9	21.9	24.7	1.4	115	258	762	215	150
1	19	13	14	17.4	19.2	22.1	24.9	1.4	117	258	774	215	150
1/0	1	16	14	18.1	19.8	22.8	25.6	1.4	145	317	870	240	170
1/0	19	16	14	18.3	20.1	23.1	25.9	1.4	147	317	883	240	170
2/0	19	20	14	19.4	21.1	24.1	26.9	1.4	186	397	1020	275	195
3/0	19	16	12	20.5	22.3	26.1	28.9	1.4	235	503	1233	315	220
4/0	19	20	12	21.9	23.6	27.5	30.3	1.4	296	629	1444	360	250

ALUMINUM UNDERGROUND DISTRIBUTION CABLE – 15 kV – TYPE UD – 1/3 NEUTRAL													
COMPACT CONDUCTOR		COPPER NEUTRAL		DIAMETER (2) (mm)				NOM. JACKET THKN. (2) (mm)	APPROX. WEIGHT (kg/km)			AMPACITY (4)	
SIZE (AWG OR kcmil)	NO. OF WIRES (1)	NO. OF WIRES	WIRE SIZE (AWG)	INS.	INS. SHIELD	NEUT. WIRES	ENCAP LLDPE JACKET		AL COND.	CU NEUT. WIRES	TOTAL	DIRECT BURIED	IN DUCT

4.45 mm (175 mils) NOMINAL TRXLPE INSULATION – 100% INSULATION LEVEL

2	1	7	16	16.4	18.1	20.4	23.2	1.4	91	87	543	170	130
2	7	7	16	16.6	18.4	20.7	23.5	1.4	93	87	555	170	130
1	1	8	16	17.1	18.9	21.2	24.0	1.4	115	100	598	195	150
1	19	8	16	17.4	19.2	21.5	24.3	1.4	117	100	609	195	150
1/0	1	9	16	18.1	19.8	22.1	24.9	1.4	145	112	662	225	170
1/0	19	9	16	18.3	20.1	22.4	25.2	1.4	147	112	675	225	170
2/0	19	11	16	19.4	21.1	23.4	26.2	1.4	186	137	763	255	200
3/0	19	9	14	20.5	22.3	25.3	28.1	1.4	235	179	906	290	225
4/0	19	11	14	21.9	23.6	26.6	29.4	1.4	296	218	1039	330	255
250	37	14	14	23.2	25.0	27.9	30.7	1.4	349	278	1181	365	280
350	37	18	14	25.7	27.4	30.4	33.2	1.4	490	357	1459	440	340
500	37	25	14	28.7	31.0	33.9	36.7	1.4	697	496	1906	530	420
750	61	24	12	33.3	35.6	39.4	43.4	2.0	1047	755	2755	640	510
1000	61	31	12	37.1	39.4	43.2	47.3	2.0	1394	976	3530	730	595

(1) For compact stranded constructions, the number of wires may be reduced as follows:
 19-Wire Constructions – 18 Wires Minimum
 37-Wire Constructions – 35 Wires Minimum
 61-Wire Constructions – 58 Wires Minimum

(2) Extruded layer thicknesses are in accordance with CSA C68.5 for Primary Shielded and Concentric Neutral Cable for Distribution Utilities.

(3) Ampacities based on earth thermal resistivity of 90°C-cm/watt, 90°C conductor temperature, 20°C earth ambient temperature, 75% load factor, and 36" depth of burial. Values based on single phase operation, with full current return in the neutral wires. Ducts sized for 40% fill. For specific ampacities, contact your General Cable sales representative.

(4) Ampacities based on earth thermal resistivity of 90°C-cm/watt, 90°C conductor temperature, 20°C earth ambient temperature, 75% load factor, and 36" depth of burial. Values based on one three phase circuit, one conductor per phase, in flat adjacent configuration with neutral wires bonded at each end. Ducts sized for 40% fill. For specific ampacities, contact your General Cable sales representative.

Dimensions and weights not designated minimum or maximum are nominal values and subject to manufacturing tolerances. In this context, weight means mass.



EmPowr® Link Underground Distribution Cable 15-46 kV

Copper Conductor TRXLPE Insulation Concentric Neutral LLDPE Jacket

COPPER UNDERGROUND DISTRIBUTION CABLE – 15 kV – TYPE URD – FULL NEUTRAL

COMPACT CONDUCTOR		COPPER NEUTRAL		DIAMETER (2) (mm)				NOM. JACKET THKN. (2) (mm)	APPROX. WEIGHT (kg/km)			AMPACITY (3)	
SIZE (AWG OR kcmil)	NO. OF WIRES (1)	NO. OF WIRES	WIRE SIZE (AWG)	INS.	INS. SHIELD	NEUT. WIRES	ENCAP LLDPE JACKET		CU COND.	CU NEUT. WIRES	TOTAL	DIRECT BURIED	IN DUCT
5.59 mm (220 mils) NOMINAL TRXLPE INSULATION – 133% INSULATION LEVEL													
2	7	16	14	18.9	20.7	23.6	26.4	1.4	305	317	1082	240	175
1	19	20	14	19.7	21.5	24.4	27.2	1.4	385	396	1254	275	200
1/0	19	26	14	20.6	22.4	25.3	28.1	1.4	485	516	1489	315	225
2/0	19	20	12	21.6	23.4	27.2	30.0	1.4	612	629	1785	360	255
3/0	19	26	12	22.8	24.6	28.4	31.2	1.4	771	818	2152	410	295
4/0	19	32	12	24.2	25.9	29.7	32.5	1.4	972	1006	2563	465	330

COPPER UNDERGROUND DISTRIBUTION CABLE – 15 kV – TYPE UD – 1/3 NEUTRAL

COMPACT CONDUCTOR		COPPER NEUTRAL		DIAMETER (2) (mm)				NOM. JACKET THKN. (2) (mm)	APPROX. WEIGHT (kg/km)			AMPACITY (4)	
SIZE (AWG OR kcmil)	NO. OF WIRES (1)	NO. OF WIRES	WIRE SIZE (AWG)	INS.	INS. SHIELD	NEUT. WIRES	ENCAP LLDPE JACKET		CU COND.	CU NEUT. WIRES	TOTAL	DIRECT BURIED	IN DUCT
5.59 mm (220 mils) NOMINAL TRXLPE INSULATION – 133% INSULATION LEVEL													
2	7	9	16	18.9	20.7	23.0	25.8	1.4	305	112	873	230	200
1	19	11	16	19.7	21.5	23.7	26.5	1.4	385	137	996	265	225
1/0	19	9	14	20.6	22.4	25.3	28.1	1.4	485	178	1187	300	255
2/0	19	11	14	21.6	23.4	26.4	29.2	1.4	612	218	1380	340	290
3/0	19	14	14	22.8	24.6	27.6	30.4	1.4	771	278	1629	385	325
4/0	19	18	14	24.2	25.9	28.9	31.7	1.4	972	357	1941	435	360
250	37	21	14	25.5	27.3	30.2	33.0	1.4	1149	417	2213	475	385
350	37	18	12	27.9	30.2	34.0	36.8	1.4	1609	566	2959	555	440
500	37	26	12	31.0	33.3	37.1	39.9	1.4	2298	818	3973	635	485
750	61	25	10	35.6	37.8	42.7	46.8	2.0	3447	1250	5820	710	540
1000	61	32	10	39.4	42.5	47.3	51.4	2.0	4596	1601	7493	760	585

(1) For compact stranded constructions, the number of wires may be reduced as follows:

- 19-Wire Constructions – 18 Wires Minimum
- 37-Wire Constructions – 35 Wires Minimum
- 61-Wire Constructions – 58 Wires Minimum

(2) Extruded layer thicknesses are in accordance with CSA C68.5 for Primary Shielded and Concentric Neutral Cable for Distribution Utilities.

(3) Ampacities based on earth thermal resistivity of 90°C-cm/watt, 90°C conductor temperature, 20°C earth ambient temperature, 75% load factor, and 36" depth of burial. Values based on single phase operation, with full current return in the neutral wires. Ducts sized for 40% fill. For specific ampacities, contact your General Cable sales representative.

(4) Ampacities based on earth thermal resistivity of 90°C-cm/watt, 90°C conductor temperature, 20°C earth ambient temperature, 75% load factor, and 36" depth of burial. Values based on one three phase circuit, one conductor per phase, in flat adjacent configuration with neutral wires bonded at each end. Ducts sized for 40% fill. For specific ampacities, contact your General Cable sales representative.

Dimensions and weights not designated minimum or maximum are nominal values and subject to manufacturing tolerances. In this context, weight means mass.



EmPowr® Link Underground Distribution Cable 15-46 kV

Aluminum Conductor TRXLPE Insulation Concentric Neutral LLDPE Jacket

ALUMINUM UNDERGROUND DISTRIBUTION CABLE – 15 kV – TYPE URD – FULL NEUTRAL

COMPACT CONDUCTOR		COPPER NEUTRAL		DIAMETER (2) (mm)				NOM. JACKET THKN. (2) (mm)	APPROX. WEIGHT (kg/km)			AMPACITY (3)	
SIZE (AWG OR kcmil)	NO. OF WIRES (1)	NO. OF WIRES	WIRE SIZE (AWG)	INS.	INS. SHIELD	NEUT. WIRES	ENCAP LLDPE JACKET		AL COND.	CU NEUT. WIRES	TOTAL	DIRECT BURIED	IN DUCT

5.59 mm (220 mils) NOMINAL TRXLPE INSULATION – 133% INSULATION LEVEL

2	1	10	14	18.6	20.4	23.4	26.2	1.4	91	198	750	190	130
2	7	10	14	18.9	20.7	23.6	26.4	1.4	93	198	763	190	130
1	1	13	14	19.4	21.2	24.2	26.9	1.4	115	258	850	215	150
1	19	13	14	19.7	21.5	24.4	27.2	1.4	117	258	862	215	150
1/0	1	16	14	20.3	22.1	25.1	27.9	1.4	145	317	960	240	170
1/0	19	16	14	20.6	22.4	25.3	28.1	1.4	147	317	974	240	170
2/0	19	20	14	21.6	23.4	26.4	29.2	1.4	186	397	1114	275	195
3/0	19	16	12	22.8	24.6	28.4	31.2	1.4	235	503	1334	315	220
4/0	19	20	12	24.2	25.9	29.7	32.5	1.4	296	629	1549	360	250

ALUMINUM UNDERGROUND DISTRIBUTION CABLE – 15 kV – TYPE UD – 1/3 NEUTRAL

COMPACT CONDUCTOR		COPPER NEUTRAL		DIAMETER (2) (mm)				NOM. JACKET THKN. (2) (mm)	APPROX. WEIGHT (kg/km)			AMPACITY (4)	
SIZE (AWG OR kcmil)	NO. OF WIRES (1)	NO. OF WIRES	WIRE SIZE (AWG)	INS.	INS. SHIELD	NEUT. WIRES	ENCAP LLDPE JACKET		AL COND.	CU NEUT. WIRES	TOTAL	DIRECT BURIED	IN DUCT

5.59 mm (220 mils) NOMINAL TRXLPE INSULATION – 133% INSULATION LEVEL

2	1	8	16	18.6	20.4	22.7	25.5	1.4	91	100	637	170	130
2	7	8	16	18.9	20.7	23.0	25.8	1.4	93	100	650	170	130
1	1	9	16	19.4	21.2	23.5	26.3	1.4	115	112	694	195	150
1	19	9	16	19.7	21.5	23.7	26.5	1.4	117	112	706	195	150
1/0	1	9	16	20.3	22.1	24.4	27.2	1.4	145	112	750	225	170
1/0	19	9	16	20.6	22.4	24.7	27.5	1.4	147	112	764	225	170
2/0	19	11	16	21.6	23.4	25.7	28.5	1.4	186	137	855	255	200
3/0	19	9	14	22.8	24.6	27.6	30.4	1.4	235	179	1005	290	225
4/0	19	11	14	24.2	25.9	28.9	31.7	1.4	296	218	1141	330	255
250	37	14	14	25.5	27.3	30.2	33.0	1.4	349	278	1288	365	280
350	37	18	14	27.9	30.2	33.2	36.0	1.4	490	357	1606	440	340
500	37	25	14	31.0	33.3	36.2	39.0	1.4	697	496	2034	530	420
750	61	24	12	35.6	37.8	41.7	45.7	2.0	1047	756	2905	640	510
1000	61	31	12	39.4	42.5	46.3	50.3	2.0	1394	977	3760	730	595

(1) For compact stranded constructions, the number of wires may be reduced as follows:

- 19-Wire Constructions – 18 Wires Minimum
- 37-Wire Constructions – 35 Wires Minimum
- 61-Wire Constructions – 58 Wires Minimum

(2) Extruded layer thicknesses are in accordance with CSA C68.5 for Primary Shielded and Concentric Neutral Cable for Distribution Utilities.

(3) Ampacities based on earth thermal resistivity of 90°C-cm/watt, 90°C conductor temperature, 20°C earth ambient temperature, 75% load factor, and 36" depth of burial. Values based on single phase operation, with full current return in the neutral wires. Ducts sized for 40% fill. For specific ampacities, contact your General Cable sales representative.

(4) Ampacities based on earth thermal resistivity of 90°C-cm/watt, 90°C conductor temperature, 20°C earth ambient temperature, 75% load factor, and 36" depth of burial. Values based on one three phase circuit, one conductor per phase, in flat adjacent configuration with neutral wires bonded at each end. Ducts sized for 40% fill. For specific ampacities, contact your General Cable sales representative.

Dimensions and weights not designated minimum or maximum are nominal values and subject to manufacturing tolerances. In this context, weight means mass.



EmPowr® Link Underground Distribution Cable 15-46 kV

Copper Conductor TRXLPE Insulation Concentric Neutral LLDPE Jacket

COPPER UNDERGROUND DISTRIBUTION CABLE – 25 kV – TYPE URD – FULL NEUTRAL

COMPACT CONDUCTOR		COPPER NEUTRAL		DIAMETER (2) (mm)				NOM. JACKET THKN. (2) (mm)	APPROX. WEIGHT (kg/km)			AMPACITY (3)	
SIZE (AWG OR kcmil)	NO. OF WIRES (1)	NO. OF WIRES	WIRE SIZE (AWG)	INS.	INS. SHIELD	NEUT. WIRES	ENCAP LLDPE JACKET		CU COND.	CU NEUT. WIRES	TOTAL	DIRECT BURIED	IN DUCT
6.60 mm (260 mils) NOMINAL TRXLPE INSULATION – 100% INSULATION LEVEL													
1	19	20	14	21.7	23.5	26.4	29.2	1.4	385	397	1339	275	200
1/0	19	26	14	22.7	24.4	27.4	30.2	1.4	485	516	1577	315	225
2/0	19	20	12	23.7	25.5	29.3	32.1	1.4	612	630	1879	360	255
3/0	19	26	12	24.9	26.6	30.5	33.2	1.4	771	819	2249	410	295
4/0	19	32	12	26.2	28.0	31.8	34.6	1.4	972	1008	2665	465	330

COPPER UNDERGROUND DISTRIBUTION CABLE – 25 kV – TYPE UD – 1/3 NEUTRAL

COMPACT CONDUCTOR		COPPER NEUTRAL		DIAMETER (2) (mm)				NOM. JACKET THKN. (2) (mm)	APPROX. WEIGHT (kg/km)			AMPACITY (4)	
SIZE (AWG OR kcmil)	NO. OF WIRES (1)	NO. OF WIRES	WIRE SIZE (AWG)	INS.	INS. SHIELD	NEUT. WIRES	ENCAP LLDPE JACKET		CU COND.	CU NEUT. WIRES	TOTAL	DIRECT BURIED	IN DUCT
6.60 mm (260 mils) NOMINAL TRXLPE INSULATION – 100% INSULATION LEVEL													
1	19	11	16	21.7	23.5	25.8	28.6	1.4	385	137	1079	260	225
1/0	19	9	14	22.7	24.4	27.4	30.2	1.4	485	179	1275	295	255
2/0	19	11	14	23.7	25.5	28.4	31.2	1.4	612	218	1471	335	290
3/0	19	14	14	24.9	26.6	29.6	32.4	1.4	771	278	1723	380	325
4/0	19	18	14	26.2	28.0	30.9	33.7	1.4	972	358	2039	430	360
250	37	21	14	27.5	29.8	32.8	35.6	1.4	1149	417	2347	470	400
350	37	18	12	30.0	32.3	36.1	38.9	1.4	1609	567	3073	555	445
500	37	26	12	33.0	35.3	39.1	43.2	2.0	2298	819	4175	635	495
750	61	25	10	37.6	39.9	44.8	48.8	2.0	3447	1251	5963	715	550
1000	61	32	10	41.5	44.5	49.4	53.4	2.0	4596	1602	7651	765	595

(1) For compact stranded constructions, the number of wires may be reduced as follows:

- 19-Wire Constructions – 18 Wires Minimum
- 37-Wire Constructions – 35 Wires Minimum
- 61-Wire Constructions – 58 Wires Minimum

(2) Extruded layer thicknesses are in accordance with CSA C68.5 for Primary Shielded and Concentric Neutral Cable for Distribution Utilities.

(3) Ampacities based on earth thermal resistivity of 90°C-cm/watt, 90°C conductor temperature, 20°C earth ambient temperature, 75% load factor, and 36" depth of burial. Values based on single phase operation, with full current return in the neutral wires. Ducts sized for 40% fill. For specific ampacities, contact your General Cable sales representative.

(4) Ampacities based on earth thermal resistivity of 90°C-cm/watt, 90°C conductor temperature, 20°C earth ambient temperature, 75% load factor, and 36" depth of burial. Values based on one three phase circuit, one conductor per phase, in flat adjacent configuration with neutral wires bonded at each end. Ducts sized for 40% fill. For specific ampacities, contact your General Cable sales representative.

Dimensions and weights not designated minimum or maximum are nominal values and subject to manufacturing tolerances. In this context, weight means mass.



EmPowr® Link Underground Distribution Cable 15-46 kV

Aluminum Conductor TRXLPE Insulation Concentric Neutral LLDPE Jacket

ALUMINUM UNDERGROUND DISTRIBUTION CABLE – 25 kV – TYPE URD – FULL NEUTRAL

COMPACT CONDUCTOR		COPPER NEUTRAL		DIAMETER (2) (mm)				NOM. JACKET THKN. (2) (mm)	APPROX. WEIGHT (kg/km)			AMPACITY (3)	
SIZE (AWG OR kcmil)	NO. OF WIRES (1)	NO. OF WIRES	WIRE SIZE (AWG)	INS.	INS. SHIELD	NEUT. WIRES	ENCAP LLDPE JACKET		AL COND.	CU NEUT. WIRES	TOTAL	DIRECT BURIED	IN DUCT

6.60 mm (260 mils) NOMINAL TRXLPE INSULATION – 100% INSULATION LEVEL

1	1	13	14	21.5	23.2	26.2	29.0	1.4	115	258	934	215	150
1	19	13	14	21.7	23.5	26.4	29.2	1.4	117	258	946	215	150
1/0	1	16	14	22.4	24.2	27.1	29.9	1.4	145	318	1047	240	170
1/0	19	16	14	22.7	24.4	27.4	30.2	1.4	147	318	1062	240	170
2/0	19	20	14	23.7	25.5	28.4	31.2	1.4	186	397	1205	275	195
3/0	19	16	12	24.9	26.6	30.5	33.2	1.4	235	504	1431	315	220
4/0	19	20	12	26.2	28.0	31.8	34.6	1.4	296	630	1650	360	250

ALUMINUM UNDERGROUND DISTRIBUTION CABLE – 25 kV – TYPE UD – 1/3 NEUTRAL

COMPACT CONDUCTOR		COPPER NEUTRAL		DIAMETER (2) (mm)				NOM. JACKET THKN. (2) (mm)	APPROX. WEIGHT (kg/km)			AMPACITY (4)	
SIZE (AWG OR kcmil)	NO. OF WIRES (1)	NO. OF WIRES	WIRE SIZE (AWG)	INS.	INS. SHIELD	NEUT. WIRES	ENCAP LLDPE JACKET		AL COND.	CU NEUT. WIRES	TOTAL	DIRECT BURIED	IN DUCT

6.60 mm (260 mils) NOMINAL TRXLPE INSULATION – 100% INSULATION LEVEL

1	1	9	16	21.5	23.2	25.5	28.3	1.4	115	112	776	195	150
1	19	9	16	21.7	23.5	25.8	28.6	1.4	117	112	789	195	150
1/0	1	9	16	22.4	24.2	26.4	29.2	1.4	145	112	835	220	170
1/0	19	9	16	22.7	24.4	26.7	29.5	1.4	147	112	849	220	170
2/0	19	11	16	23.7	25.5	27.7	30.5	1.4	186	137	943	250	200
3/0	19	14	16	24.9	26.6	28.9	31.7	1.4	235	175	1065	290	225
4/0	19	11	14	26.2	28.0	30.9	33.7	1.4	296	218	1239	330	255
250	37	14	14	27.5	29.8	32.8	35.6	1.4	349	278	1422	360	280
350	37	18	14	30.0	32.3	35.2	38.0	1.4	490	358	1717	435	340
500	37	25	14	33.0	35.3	38.3	41.0	1.4	697	497	2154	525	420
750	61	24	12	37.6	39.9	43.7	47.8	2.0	1047	756	3045	640	510
1000	61	31	12	41.5	44.5	48.3	52.4	2.0	1394	977	3807	730	595

(1) For compact stranded constructions, the number of wires may be reduced as follows:

- 19-Wire Constructions – 18 Wires Minimum
- 37-Wire Constructions – 35 Wires Minimum
- 61-Wire Constructions – 58 Wires Minimum

(2) Extruded layer thicknesses are in accordance with CSA C68.5 for Primary Shielded and Concentric Neutral Cable for Distribution Utilities.

(3) Ampacities based on earth thermal resistivity of 90°C-cm/watt, 90°C conductor temperature, 20°C earth ambient temperature, 75% load factor, and 36" depth of burial. Values based on single phase operation, with full current return in the neutral wires. Ducts sized for 40% fill. For specific ampacities, contact your General Cable sales representative.

(4) Ampacities based on earth thermal resistivity of 90°C-cm/watt, 90°C conductor temperature, 20°C earth ambient temperature, 75% load factor, and 36" depth of burial. Values based on one three phase circuit, one conductor per phase, in flat adjacent configuration with neutral wires bonded at each end. Ducts sized for 40% fill. For specific ampacities, contact your General Cable sales representative.

Dimensions and weights not designated minimum or maximum are nominal values and subject to manufacturing tolerances. In this context, weight means mass.



EmPowr® Link Underground Distribution Cable 15-46 kV

Copper Conductor TRXLPE Insulation Concentric Neutral LLDPE Jacket

COPPER UNDERGROUND DISTRIBUTION CABLE – 28 kV – TYPE URD – FULL NEUTRAL													
COMPACT CONDUCTOR		COPPER NEUTRAL		DIAMETER (2) (mm)				NOM. JACKET THKN. (2) (mm)	APPROX. WEIGHT (kg/km)			AMPACITY (3)	
SIZE (AWG OR kcmil)	NO. OF WIRES (1)	NO. OF WIRES	WIRE SIZE (AWG)	INS.	INS. SHIELD	NEUT. WIRES	ENCAP LLDPE JACKET		CU COND.	CU NEUT. WIRES	TOTAL	DIRECT BURIED	IN DUCT

7.11 mm (280 mils) NOMINAL TRXLPE INSULATION – 100% INSULATION LEVEL

1	19	20	14	22.7	24.5	27.5	30.3	1.4	385	397	1383	275	200
1/0	19	26	14	23.7	25.5	28.4	31.2	1.4	485	516	1623	315	225
2/0	19	20	12	24.7	26.5	30.3	33.1	1.4	612	630	1927	360	255
3/0	19	26	12	25.9	27.7	31.5	34.3	1.4	771	819	2299	410	295
4/0	19	32	12	27.2	29.5	33.3	36.1	1.4	972	1008	2749	465	330

COPPER UNDERGROUND DISTRIBUTION CABLE – 28 kV – TYPE UD – 1/3 NEUTRAL													
COMPACT CONDUCTOR		COPPER NEUTRAL		DIAMETER (2) (mm)				NOM. JACKET THKN. (2) (mm)	APPROX. WEIGHT (kg/km)			AMPACITY (4)	
SIZE (AWG OR kcmil)	NO. OF WIRES (1)	NO. OF WIRES	WIRE SIZE (AWG)	INS.	INS. SHIELD	NEUT. WIRES	ENCAP LLDPE JACKET		CU COND.	CU NEUT. WIRES	TOTAL	DIRECT BURIED	IN DUCT

7.11 mm (280 mils) NOMINAL TRXLPE INSULATION – 100% INSULATION LEVEL

1	19	11	16	22.7	24.5	26.8	29.6	1.4	385	137	1122	260	225
1/0	19	14	16	23.7	25.5	27.7	30.5	1.4	485	175	1288	295	255
2/0	19	11	14	24.7	26.5	29.4	32.2	1.4	612	218	1518	335	290
3/0	19	14	14	25.9	27.7	30.6	33.4	1.4	771	278	1772	380	325
4/0	19	18	14	27.2	29.5	32.4	35.2	1.4	972	358	2122	430	360
250	37	21	14	28.5	30.8	33.8	36.6	1.4	1149	417	2401	470	400
350	37	18	12	31.0	33.3	37.1	39.9	1.4	1609	567	3131	555	445
500	37	26	12	34.0	36.3	40.1	44.2	2.0	2298	819	4240	635	495
750	61	25	10	38.6	40.9	45.8	49.8	2.0	3447	1251	6037	715	550
1000	61	32	10	42.5	45.5	50.4	54.5	2.0	4596	1603	7731	765	595

(1) For compact stranded constructions, the number of wires may be reduced as follows:

- 19-Wire Constructions – 18 Wires Minimum
- 37-Wire Constructions – 35 Wires Minimum
- 61-Wire Constructions – 58 Wires Minimum

(2) Extruded layer thicknesses are in accordance with CSA C68.5 for Primary Shielded and Concentric Neutral Cable for Distribution Utilities.

(3) Ampacities based on earth thermal resistivity of 90°C-cm/watt, 90°C conductor temperature, 20°C earth ambient temperature, 75% load factor, and 36" depth of burial. Values based on single phase operation, with full current return in the neutral wires. Ducts sized for 40% fill. For specific ampacities, contact your General Cable sales representative.

(4) Ampacities based on earth thermal resistivity of 90°C-cm/watt, 90°C conductor temperature, 20°C earth ambient temperature, 75% load factor, and 36" depth of burial. Values based on one three phase circuit, one conductor per phase, in flat adjacent configuration with neutral wires bonded at each end. Ducts sized for 40% fill. For specific ampacities, contact your General Cable sales representative.

Dimensions and weights not designated minimum or maximum are nominal values and subject to manufacturing tolerances. In this context, weight means mass.



EmPowr® Link Underground Distribution Cable 15-46 kV

Aluminum Conductor TRXLPE Insulation Concentric Neutral LLDPE Jacket

ALUMINUM UNDERGROUND DISTRIBUTION CABLE – 28 kV – TYPE URD – FULL NEUTRAL

COMPACT CONDUCTOR		COPPER NEUTRAL		DIAMETER (2) (mm)				NOM. JACKET THKN. (2) (mm)	APPROX. WEIGHT (kg/km)			AMPACITY (3)	
SIZE (AWG OR kcmil)	NO. OF WIRES (1)	NO. OF WIRES	WIRE SIZE (AWG)	INS.	INS. SHIELD	NEUT. WIRES	ENCAP LLDPE JACKET		AL COND.	CU NEUT. WIRES	TOTAL	DIRECT BURIED	IN DUCT

7.11 mm (280 mils) NOMINAL TRXLPE INSULATION – 100% INSULATION LEVEL

1	1	13	14	22.5	24.3	27.2	30.0	1.4	115	258	978	215	150
1	19	13	14	22.7	24.5	27.5	30.3	1.4	117	258	991	215	150
1/0	1	16	14	23.4	25.2	28.1	30.9	1.4	145	318	1092	240	170
1/0	19	16	14	23.7	25.5	28.4	31.2	1.4	147	318	1108	240	170
2/0	19	20	14	24.7	26.5	29.4	32.2	1.4	186	397	1253	275	195
3/0	19	16	12	25.9	27.7	31.5	34.3	1.4	235	504	1481	315	220
4/0	19	20	12	27.2	29.5	33.3	36.1	1.4	296	630	1735	360	250

ALUMINUM UNDERGROUND DISTRIBUTION CABLE – 28 kV – TYPE UD – 1/3 NEUTRAL

COMPACT CONDUCTOR		COPPER NEUTRAL		DIAMETER (2) (mm)				NOM. JACKET THKN. (2) (mm)	APPROX. WEIGHT (kg/km)			AMPACITY (4)	
SIZE (AWG OR kcmil)	NO. OF WIRES (1)	NO. OF WIRES	WIRE SIZE (AWG)	INS.	INS. SHIELD	NEUT. WIRES	ENCAP LLDPE JACKET		AL COND.	CU NEUT. WIRES	TOTAL	DIRECT BURIED	IN DUCT

7.11 mm (280 mils) NOMINAL TRXLPE INSULATION – 100% INSULATION LEVEL

1	1	10	16	22.5	24.3	26.5	29.3	1.4	115	125	830	195	150
1	19	10	16	22.7	24.5	26.8	29.6	1.4	117	125	843	195	150
1/0	1	10	16	23.4	25.2	27.5	30.3	1.4	145	125	890	220	170
1/0	19	10	16	23.7	25.5	27.7	30.5	1.4	147	125	906	220	170
2/0	19	11	16	24.7	26.5	28.8	31.5	1.4	186	137	990	250	200
3/0	19	14	16	25.9	27.7	29.9	32.7	1.4	235	175	1113	290	225
4/0	19	11	14	27.2	29.5	32.4	35.2	1.4	296	218	1322	330	255
250	37	14	14	28.5	30.8	33.8	36.6	1.4	349	278	1476	360	280
350	37	18	14	31.0	33.3	36.2	39.0	1.4	490	358	1775	435	340
500	37	25	14	34.0	36.3	39.3	43.3	2.0	697	497	2295	525	420
750	61	24	12	38.6	40.9	44.7	48.8	2.0	1047	756	3117	640	510
1000	61	31	12	42.5	45.5	49.3	53.4	2.0	1394	977	3886	730	595

(1) For compact stranded constructions, the number of wires may be reduced as follows:

- 19-Wire Constructions – 18 Wires Minimum
- 37-Wire Constructions – 35 Wires Minimum
- 61-Wire Constructions – 58 Wires Minimum

(2) Extruded layer thicknesses are in accordance with CSA C68.5 for Primary Shielded and Concentric Neutral Cable for Distribution Utilities.

(3) Ampacities based on earth thermal resistivity of 90°C-cm/watt, 90°C conductor temperature, 20°C earth ambient temperature, 75% load factor, and 36" depth of burial. Values based on single phase operation, with full current return in the neutral wires. Ducts sized for 40% fill. For specific ampacities, contact your General Cable sales representative.

(4) Ampacities based on earth thermal resistivity of 90°C-cm/watt, 90°C conductor temperature, 20°C earth ambient temperature, 75% load factor, and 36" depth of burial. Values based on one three phase circuit, one conductor per phase, in flat adjacent configuration with neutral wires bonded at each end. Ducts sized for 40% fill. For specific ampacities, contact your General Cable sales representative.

Dimensions and weights not designated minimum or maximum are nominal values and subject to manufacturing tolerances. In this context, weight means mass.



EmPowr® Link Underground Distribution Cable 15-46 kV

Copper Conductor TRXLPE Insulation Concentric Neutral LLDPE Jacket

COPPER UNDERGROUND DISTRIBUTION CABLE – 35 kV – TYPE URD – FULL NEUTRAL

COMPACT CONDUCTOR		COPPER NEUTRAL		DIAMETER (2) (mm)				NOM. JACKET THKN. (2) (mm)	APPROX. WEIGHT (kg/km)			AMPACITY (3)	
SIZE (AWG OR kcmil)	NO. OF WIRES (1)	NO. OF WIRES	WIRE SIZE (AWG)	INS.	INS. SHIELD	NEUT. WIRES	ENCAP LLDPE JACKET		CU COND.	CU NEUT. WIRES	TOTAL	DIRECT BURIED	IN DUCT
8.76 mm (345 mils) NOMINAL TRXLPE INSULATION – 100% INSULATION LEVEL													
1/0	19	26	14	27.0	29.3	32.2	35.0	1.4	485	516	1814	315	225
2/0	19	20	12	28.0	30.3	34.1	36.9	1.4	612	630	2129	360	255
3/0	19	26	12	29.2	31.5	35.3	38.1	1.4	771	819	2508	410	295
4/0	19	32	12	30.5	32.8	36.6	39.4	1.4	972	1008	2933	465	330

COPPER UNDERGROUND DISTRIBUTION CABLE – 35 kV – TYPE UD – 1/3 NEUTRAL

COMPACT CONDUCTOR		COPPER NEUTRAL		DIAMETER (2) (mm)				NOM. JACKET THKN. (2) (mm)	APPROX. WEIGHT (kg/km)			AMPACITY (4)	
SIZE (AWG OR kcmil)	NO. OF WIRES (1)	NO. OF WIRES	WIRE SIZE (AWG)	INS.	INS. SHIELD	NEUT. WIRES	ENCAP LLDPE JACKET		CU COND.	CU NEUT. WIRES	TOTAL	DIRECT BURIED	IN DUCT
8.76 mm (345 mils) NOMINAL TRXLPE INSULATION – 100% INSULATION LEVEL													
1/0	19	14	16	27.0	29.3	31.5	34.3	1.4	485	175	1475	295	255
2/0	19	11	14	28.0	30.3	33.2	36.0	1.4	612	219	1714	335	290
3/0	19	14	14	29.2	31.5	34.4	37.2	1.4	771	278	1976	380	325
4/0	19	18	14	30.5	32.8	35.7	38.5	1.4	972	358	2301	430	360
250	37	21	14	31.9	34.1	37.1	39.9	1.4	1149	417	2586	470	400
350	37	18	12	34.3	36.6	40.4	44.5	2.0	1609	567	3414	555	445
500	37	26	12	37.3	39.6	43.4	47.5	2.0	2298	819	4462	635	495
750	61	25	10	41.9	45.0	49.8	53.9	2.0	3447	1252	6359	715	550
1000	61	32	10	45.8	48.8	53.7	57.8	2.0	4596	1603	8004	765	595

(1) For compact stranded constructions, the number of wires may be reduced as follows:

- 19-Wire Constructions – 18 Wires Minimum
- 37-Wire Constructions – 35 Wires Minimum
- 61-Wire Constructions – 58 Wires Minimum

(2) Extruded layer thicknesses are in accordance with CSA C68.5 for Primary Shielded and Concentric Neutral Cable for Distribution Utilities.

(3) Ampacities based on earth thermal resistivity of 90°C-cm/watt, 90°C conductor temperature, 20°C earth ambient temperature, 75% load factor, and 36" depth of burial. Values based on single phase operation, with full current return in the neutral wires. Ducts sized for 40% fill. For specific ampacities, contact your General Cable sales representative.

(4) Ampacities based on earth thermal resistivity of 90°C-cm/watt, 90°C conductor temperature, 20°C earth ambient temperature, 75% load factor, and 36" depth of burial. Values based on one three phase circuit, one conductor per phase, in flat adjacent configuration with neutral wires bonded at each end. Ducts sized for 40% fill. For specific ampacities, contact your General Cable sales representative.

Dimensions and weights not designated minimum or maximum are nominal values and subject to manufacturing tolerances. In this context, weight means mass.



EmPowr® Link Underground Distribution Cable 15-46 kV

Aluminum Conductor TRXLPE Insulation Concentric Neutral LLDPE Jacket

ALUMINUM UNDERGROUND DISTRIBUTION CABLE – 35 kV – TYPE URD – FULL NEUTRAL

COMPACT CONDUCTOR		COPPER NEUTRAL		DIAMETER (2) (mm)				NOM. JACKET THKN. (2) (mm)	APPROX. WEIGHT (kg/km)			AMPACITY (3)	
SIZE (AWG OR kcmil)	NO. OF WIRES (1)	NO. OF WIRES	WIRE SIZE (AWG)	INS.	INS. SHIELD	NEUT. WIRES	ENCAP LLDPE JACKET		AL COND.	CU NEUT. WIRES	TOTAL	DIRECT BURIED	IN DUCT

8.76 mm (345 mils) NOMINAL TRXLPE INSULATION – 100% INSULATION LEVEL

1/0	1	16	14	26.7	29.0	31.9	34.7	1.4	145	318	1281	240	170
1/0	19	16	14	27.0	29.3	32.2	35.0	1.4	147	318	1298	240	170
2/0	19	20	14	28.0	30.3	33.2	36.0	1.4	186	397	1449	275	195
3/0	19	16	12	29.2	31.5	35.3	38.1	1.4	235	504	1689	315	220
4/0	19	20	12	30.5	32.8	36.6	39.4	1.4	296	630	1918	360	250

ALUMINUM UNDERGROUND DISTRIBUTION CABLE – 35 kV – TYPE UD – 1/3 NEUTRAL

COMPACT CONDUCTOR		COPPER NEUTRAL		DIAMETER (2) (mm)				NOM. JACKET THKN. (2) (mm)	APPROX. WEIGHT (kg/km)			AMPACITY (4)	
SIZE (AWG OR kcmil)	NO. OF WIRES (1)	NO. OF WIRES	WIRE SIZE (AWG)	INS.	INS. SHIELD	NEUT. WIRES	ENCAP LLDPE JACKET		AL COND.	CU NEUT. WIRES	TOTAL	DIRECT BURIED	IN DUCT

8.76 mm (345 mils) NOMINAL TRXLPE INSULATION – 100% INSULATION LEVEL

1/0	1	11	16	26.7	29.0	31.3	34.1	1.4	145	137	1087	220	170
1/0	19	11	16	27.0	29.3	31.5	34.3	1.4	147	137	1104	220	170
2/0	19	12	16	28.0	30.3	32.6	35.4	1.4	186	150	1194	250	200
3/0	19	14	16	29.2	31.5	33.8	36.6	1.4	235	175	1312	290	225
4/0	19	17	16	30.5	32.8	35.1	37.9	1.4	296	212	1459	330	255
250	37	21	16	31.9	34.1	36.4	39.2	1.4	349	262	1610	360	280
350	37	18	14	34.3	36.6	39.5	43.6	2.0	490	358	2052	435	340
500	37	25	14	37.3	39.6	42.6	46.6	2.0	697	497	2513	525	420
750	61	24	12	41.9	45.0	48.8	52.8	2.0	1047	757	3432	640	510
1000	61	31	12	45.8	48.8	52.6	56.7	2.0	1394	977	4154	730	595

(1) For compact stranded constructions, the number of wires may be reduced as follows:

- 19-Wire Constructions – 18 Wires Minimum
- 37-Wire Constructions – 35 Wires Minimum
- 61-Wire Constructions – 58 Wires Minimum

(2) Extruded layer thicknesses are in accordance with CSA C68.5 for Primary Shielded and Concentric Neutral Cable for Distribution Utilities.

(3) Ampacities based on earth thermal resistivity of 90°C-cm/watt, 90°C conductor temperature, 20°C earth ambient temperature, 75% load factor, and 36" depth of burial. Values based on single phase operation, with full current return in the neutral wires. Ducts sized for 40% fill. For specific ampacities, contact your General Cable sales representative.

(4) Ampacities based on earth thermal resistivity of 90°C-cm/watt, 90°C conductor temperature, 20°C earth ambient temperature, 75% load factor, and 36" depth of burial. Values based on one three phase circuit, one conductor per phase, in flat adjacent configuration with neutral wires bonded at each end. Ducts sized for 40% fill. For specific ampacities, contact your General Cable sales representative.

Dimensions and weights not designated minimum or maximum are nominal values and subject to manufacturing tolerances. In this context, weight means mass.



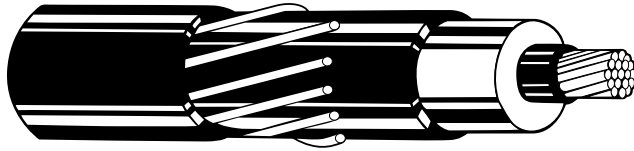

1.0 SCOPE

This specification covers single conductor tree-retardant cross-linked polyethylene insulated, concentric neutral cables rated from 15 kV to 46 kV. The cable shall be suitable for both single- and three-phase primary underground distribution (UD) for installation in underground ducts, conduit and direct burial in wet or dry locations. It shall also be suitable for on-grade and aerial installations. The cable shall be rated 90°C for normal operation, 130°C for emergency overload, and 250°C for short-circuit conditions in accordance with the latest revision of CSA C68.5.

2.0 GENERAL

Cable shall meet or exceed the latest requirements of the following industry specifications and standards. The order of precedent is as follows: 1) Customer Specification, 2) CSA C68.5. Where a particular product requirement or characteristic is specified in more than one document, the most stringent requirement will apply. Wherever reference is made to an industry specification or standard, it shall be understood to be the latest edition of that document.

3.0 QUALITY ASSURANCE

The cable shall be produced with the conductor shield, insulation and insulation shield applied in the same extrusion operation. All three extruded layers shall be applied in a common extruder head. A dry-cure process shall be used.

4.0 CONDUCTORS

The central conductor shall be either solid or stranded. If stranded, it shall be filled with a material compatible with the conductor and the conductor shield to prevent the longitudinal penetration of water into the conductor. Solid aluminum shall meet the requirements of CSA C68.5 Clause 4. Stranded aluminum conductor shall be Class B, compressed per CSA C68.5 Clause 4. Conductor temper shall be H-16 to H-19 (3/4 to hard drawn) for stranded conductors and H-14 to H-16 (1/2 to 3/4 hard) for solid conductors.

5.0 CONDUCTOR SHIELD

The conductor shield shall be an extruded thermosetting semi-conductive material complying with the applicable requirements of CSA C68.5 Clause 5. The extruded shield shall be easily removable from the conductor and shall be firmly bonded to the overlying insulation.

6.0 INSULATION

The insulation shall be a tree-retardant cross-linked polyethylene and shall comply with CSA C68.5 Clause 6. The thickness shall be as required by CSA C68.5 Table 11. An insulation pellet inspection

system capable of examining 100% of the insulation pellets and rejecting contaminants shall be used. The manufacturer shall state the method used to examine and reject contaminated pellets.

7.0 INSULATION SHIELDING

The insulation shield shall be a thermosetting semi-conductive material complying with the applicable requirements of CSA C68.5 Clause 7.

8.0 CONCENTRIC NEUTRAL

The concentric neutral conductor shall consist of bare annealed copper wires per CSA C68.5 Clause 8, applied helically and essentially equally spaced over the outer semi-conducting shield, with a lay length of not less than six nor more than ten times the diameter over the concentric neutral conductor. The neutral indents in the insulation shield shall be within the requirements of CSA C68.5 Clause 7.2. The cable shall contain water-blocking components for the concentric neutral, and the completed cable longitudinal water penetration resistance shall comply with the requirements of CSA C68.5 Clause 8 and ANSI/ICEA T-34-664.

9.0 OVERALL OUTER JACKET*

The outer jacket is an extruded-to-fill black non-conducting cross-linked polyethylene jacket with higher temperature resistance performance than standard LLDPE as specified in CSA C68.5. The jacket meets the physical requirements of Table 1 when tested by the methods specified in CSA C68.5 Clause 11. The jacket shall be free-stripping and not interfere with an intimate contact between the neutral wires and the underlying extruded insulation shield. The jacket shall contain a print legend marking and sequential length marking.

10.0 TESTS

All tests required by the referenced specifications shall be performed and passed prior to shipment, and a certified copy of the results of the tests shall be sent to the customer, if so requested. The manufacturer shall either submit with the quotation, or have on file with the customer, certified support data for the qualification tests required by CSA C68.5 Clause 12 as applicable.

11.0 EXCEPTIONS

All exceptions to these specifications are to be clearly stated in the bid proposal and will require the review and approval of the customer.

Table 1: Physical Properties of Extruded-to-Fill XLPE Jacket

PHYSICAL REQUIREMENTS	VALUES
Unaged Tensile Strength, Min. (psi)	1500
Aged* Tensile Strength, Min. Ret. (%)	70
Unaged Elongated, Min. (%)	150
Aged* Elongated, Min. Ret. (%)	70
Heat Distortion 1 hr at 131°C, Max. (%)	30

*Aged for 168 hrs at 121°C.



COMPRESSED CONDUCTOR CLASS B STRAND			INS. DIAMETER (1)		NOM. JACKET THKN. (1)	LLDPE JACKET										EMPOWR® LINK CL™										TYPICAL LENGTH (5)	COND. SIZE
			IN (mm)			NEUTRAL CONFIGURATION				NOM. JACKET O.D.	AMPACITY (2)		APPROX. SHIELD FAULT CAPACITY (4)	NEUTRAL CONFIGURATION			NOM. JACKET O.D.	AMPACITY (2)		APPROX. TOTAL WT.							
AL (AWG or kcmil)	NOM. COND. DIA.	APPROX. AL WT.	MIN. INS. O.D.	MAX. INS. O.D.	LLDPE JACKET	NEUT. SIZE	NO. OF WIRES	WIRE SIZE (AWG)	APPROX. CU WT. (1)		INCHES (mm)	DIRECT BURIED		CURRENT @ 6 CYCLES (AMPS)	NO. OF WIRES	WIRE SIZE (AWG)		APPROX. CU WT. (1)	INCHES (mm)		DIRECT BURIED		LBS/KFT (kg/km)	FT (m)	AL (AWG or kcmil)		
										LBS/KFT (kg/km)		LBS/KFT (kg/km)	FLAT (3)				TREFOIL			FLAT (3)	TREFOIL						
1/0	0.362 (9.19)	99 (147)	1.045 (26.54)	1.145 (29.08)	0.055 (1.40)	Full	16	14	214 (318)	1.404 (35.66)	245	230	13500	19	16	159 (237)	1.377 (34.99)	245	230	831 (1236)	8000 (2450)	1/0					
						2/3	17	16	143 (213)	1.378 (35.00)	245	230	9000	13	16	109 (162)	1.377 (34.99)	245	230	786 (1169)							
						1/2	13	16	109 (162)	1.378 (35.00)	250	230	6900	10	16	84 (125)	1.377 (34.99)	250	230	778 (1158)							
						1/3	9	16	76 (113)	1.378 (35.00)	250	230	4800	7	16	59 (88)	1.377 (34.99)	250	230	778 (1158)							
3/0	0.456 (11.58)	158 (235)	1.140 (28.96)	1.240 (31.50)	0.055 (1.40)	Full	16	12	339 (504)	1.532 (38.91)	310	300	21400	18	14	240 (357)	1.498 (38.05)	315	300	1053 (1567)	7000 (2150)	3/0					
						2/3	17	14	227 (338)	1.498 (38.05)	315	300	14300	20	16	168 (250)	1.471 (37.37)	315	300	964 (1434)							
						1/2	20	16	168 (250)	1.472 (37.39)	315	300	10600	15	16	126 (187)	1.471 (37.37)	320	300	927 (1379)							
						1/3	14	16	118 (176)	1.472 (37.39)	320	300	7400	10	16	84 (125)	1.471 (37.37)	320	300	912 (1357)							
4/0	0.512 (13.00)	199 (296)	1.195 (30.35)	1.295 (32.89)	0.055 (1.40)	Full	20	12	423 (630)	1.588 (40.34)	350	340	26800	23	14	307 (457)	1.554 (39.47)	350	340	1196 (1780)	7000 (2150)	4/0					
						2/3	21	14	280 (417)	1.554 (39.47)	355	340	17700	16	14	214 (318)	1.554 (39.47)	355	340	1112 (1655)							
						1/2	16	14	214 (318)	1.554 (39.47)	355	340	13500	19	16	159 (237)	1.528 (38.81)	360	340	1038 (1544)							
						1/3	17	16	143 (213)	1.528 (38.81)	360	340	9000	13	16	109 (162)	1.528 (38.81)	365	340	993 (1477)							
350	0.661 (16.79)	329 (490)	1.355 (34.42)	1.455 (36.96)	0.080 (2.03)	2/3	22	12	466 (693)	1.797 (45.64)	440	445	29500	26	14	347 (516)	1.763 (44.78)	445	445	1542 (2294)	5000 (1500)	350					
						1/2	26	14	347 (516)	1.763 (44.78)	445	445	21900	30	16	252 (375)	1.737 (44.12)	455	445	1428 (2125)							
						1/3	28	16	235 (350)	1.737 (44.12)	455	450	14800	20	16	168 (250)	1.737 (44.12)	465	450	1353 (2013)							
						1/6	14	16	118 (176)	1.737 (44.12)	475	450	7400	10	16	84 (125)	1.737 (44.12)	475	450	1278 (1902)							
500	0.789 (20.04)	468 (697)	1.480 (37.59)	1.580 (40.13)	0.080 (2.03)	2/3	20	10	673 (1002)	1.967 (49.96)	505	535	42600	23	12	487 (725)	1.925 (48.90)	510	540	1952 (2904)	5000 (1500)	500					
						1/2	24	12	508 (757)	1.925 (48.90)	510	540	32200	27	14	361 (537)	1.891 (48.03)	520	540	1798 (2675)							
						1/3	25	14	334 (497)	1.891 (48.03)	525	545	21100	29	16	243 (362)	1.865 (47.37)	540	545	1662 (2473)							
						1/6	20	16	168 (250)	1.865 (47.37)	555	545	10600	15	16	126 (188)	1.865 (47.37)	570	550	1565 (2328)							
750	0.968 (24.59)	703 (1047)	1.670 (42.42)	1.770 (44.96)	0.080 (2.03)	1/2	22	10	741 (1102)	2.184 (55.47)	585	655	49600	26	12	551 (820)	2.142 (54.41)	590	660	2461 (3662)	5000 (1500)	750					
						1/3	24	12	508 (757)	2.142 (54.41)	595	665	32200	27	14	361 (537)	2.108 (53.54)	615	670	2245 (3340)							
						1/6	30	16	252 (375)	2.082 (52.88)	645	675	15900	22	16	185 (275)	2.082 (52.88)	670	680	2053 (3055)							
1000	1.117 (28.37)	937 (1394)	1.815 (46.10)	1.920 (48.77)	0.080 (2.03)	1/2	30	10	1010 (1503)	2.333 (59.26)	650	740	64000	22	10	741 (1102)	2.333 (59.26)	650	760	3690 (5490)	4000 (1200)	1000					
						1/3	20	10	673 (1002)	2.333 (59.26)	645	755	42600	23	12	487 (725)	2.291 (58.19)	660	765	2774 (4127)							
						1/6	25	14	334 (497)	2.257 (57.32)	695	775	21100	29	16	243 (362)	2.231 (56.67)	725	785	2470 (3676)							
1250	1.251 (31.78)	1172 (1744)	1.960 (49.78)	2.065 (52.45)	0.080 (2.03)	1/3	25	10	842 (1253)	2.481 (63.02)	690	825	53300	29	12	615 (915)	2.439 (61.95)	700	845	3271 (4867)	3500 (1050)	1250					
						1/6	20	12	424 (631)	2.439 (61.95)	730	855	26800	23	14	307 (457)	2.405 (61.09)	765	870	2943 (4379)							
						1/12	25	16	210 (313)	2.405 (61.09)	815	880	13200	18	16	151 (225)	2.379 (60.43)	850	885	2779 (4136)							

(1) Extruded layer thicknesses and insulation and insulation shield diameters are in accordance with CSA C68.5. Dimensions and weights not designated as minimum or maximum are nominal values and are subject to manufacturing tolerances.

(2) Ampacity based on earth thermal resistivity of 90°C-cm/watt, 90°C conductor temperature, 20°C earth ambient temperature, 75% load factor and 36" depth of burial. Values are based on one three-phase circuit, one conductor per phase, with neutral wires bonded at each end.

(3) Cables buried in flat configuration with 7.5" spacing between conductors.

(4) EmPowr® Link CL™ neutral configurations are designed to provide equivalent shield fault capacity of the corresponding neutrals, based on LLDPE jackets with 90°C normal operation.

(5) Based on capacity of 96" non-returnable wood reels.

EmPowr[®] *Link CL*[™] *ADVANTAGE*

Built for Endurance, Economics, Efficiency, Environment

EmPowr[®] Link CL[™] Advantage—the next evolutionary step in medium-voltage technology for renewable energy collection systems.

- Enhanced Ruggedized Installation Protection
- Reduced Weight and Diameter
- Superior XLPE Jacket Technology
- Highly Efficient Fault Current Protection

An Even Greater CL Advantage

General Cable has once again taken the next step in improving medium-voltage cable with superior physical characteristics for cost-effective renewable wind and solar energy collection systems. Building upon the widely accepted and innovative electrical advancements of Cross-linked Polyethylene (XLPE) jacketing coupled with reduced neutral redesigns, **EmPowr Link CL Advantage** provides superior protection in a compact, lightweight cable that delivers more *Advantage* than ever before.

The Endurance CL Advantage

EmPowr Link CL Advantage's XLPE jacketing outperforms typical LLDPE jackets in impact and scoring resistance, providing a cable that physically endures the rigors of today's direct buried installation techniques, subsoil conditions and the frequent handling of reels found in renewable collection system installations.

The Economics CL Advantage

Rather than typical round concentric neutral wires, industry-proven flat strap neutrals under the CL jacket provide better mechanical protection for the insulated core to withstand the pressures of automated cable handling equipment and an armor-like force to resist potential underground damages, minimizing risk of expensive repairs while optimizing profitability.

The Efficiency CL Advantage

The combination of a compact phase conductor and flat strap neutrals provides a lighter weight cable with an overall smaller diameter for longer cable lengths and highly efficient fault current protection. Together with the CL XLPE jacket's proven thermomechanical properties, EmPowr Link CL Advantage offers long-term efficiencies over the life of the cable.

The Environment CL Advantage

EmPowr Link CL Advantage's superior physical characteristics, smaller diameter and long-term performance make it the most environmentally friendly medium-voltage cable for today's solar and wind construction market. With built-in benefits, lead-free compounds and General Cable's returnable reels and carbon credit value, CL Advantage is the total green solution.





Industry-Leading Reliability, Performance and Installation

EmPowr® Link CL™ Advantage is more durable and easier to install, making it the new standard for today's solar and wind farm collection systems while providing industry-leading reliability and performance. The test data on every purchase of EmPowr Link CL Advantage medium-voltage cable lets you know you're getting the performance you expect.

EmPowr Link CL Advantage The Better Choice*

Utilities have historically used Linear Low Density Polyethylene (LLDPE) thermoplastic jackets and round concentric neutrals. The future of renewable medium-voltage cable is thermoset XLPE jackets with flat strap neutrals that provide a lower-total-cost solution.

Approximately 25% reduction in copper

LLDPE jackets are limited to a maximum transient temperature of 200°C versus XLPE's 350°C (per ICEA P-45-482 calculations). The higher temperature limit provides greater fault current capability for a given cross-sectional area, reducing required copper in the neutrals. It also reduces operating temperature, providing higher cable ampacities.

Reduced shield losses equate to lower line losses

Reduced copper flat strap neutrals also increase shield resistance for lower losses due to circulating currents—especially apparent in larger kcmil sizes.

Enhanced installation and reliability

EmPowr Link CL Advantage is proven to maintain the same jacket stripping and coefficient of friction of a traditional EmPowr Link LLDPE jacket construction. Compact phase conductor and flat strap neutrals further reduce overall diameter and significantly improve durability for even easier installation and long-term reliability.



Copyright© 2013 PLC Trenching Co., LLC.

Photograph courtesy of PLC Trenching Co., LLC.

Superior thermomechanical performance resists deformation

Through CSA C68.5 thermomechanical testing simulating three-conductor installed performance, EmPowr Link CL Advantage XLPE-jacketed cables passed 3 x 1/C Cable/Conduit 140°C testing with no problem areas, while traditional LLDPE jacketed cables melted and fused together, causing exposed neutrals at some locations.



EmPowr® Link CL™ Advantage jacketed cables: These cables passed 3 x 1/C Cable/Conduit 140°C testing with no problem areas.

* EmPowr Link CL Advantage is rated 105°C in accordance with the CSA C68.5 standard. It should be noted that utilizing a 105°C normal operating conductor temperature will increase cable ampacity rating but will reduce the shield fault capability slightly. If the user plans on operating these cables at 105°C conductor temperature for normal operation and 140°C for emergency overload, please contact General Cable for the applicable cable ampacity and shield fault capability ratings. Another important consideration is that the migration of soil moisture away from the cable is more likely at the higher operating conductor temperature and can result in an increase in soil thermal resistivity, resulting in an increase in conductor and soil temperature.



PowrPak®

The Next Generation of MV-UD Cable

From the early 1920s through the late 1990s, Paper Insulated Lead Covered (PILC) cable was the standard cable used for Primary Distribution Network cable. But as load demands increased, environmental concerns grew and urban distribution systems aged, it became necessary to develop a new cable design. PowrPak® is that cable.

- > **Increased Load Capacity**
- > **More Environmentally Friendly**
- > **Easier to Retrofit**
- > ***Now Available with Lead-Free Filled EAM Insulation***



Over 119 Million Feet Installed Since 1989

Easier Splicing, Terminating and Installation

Paper Insulated Lead Covered (PILC) cable with three conductors within a common lead sheath is stiff, heavy and difficult to handle. Plus, the special skills required for terminating and splicing are limited and labor-intensive. PowrPak® is easy to work with because it is three single conductors, more flexible and lighter than lead-encased oil-impregnated PILC, and uses commercially available splicing and terminating components. Retrofitting into existing duct work is easier and less labor-intensive, which results in reduced handling, installation and overall costs.

Pack More Power Into a Smaller Cable

PowrPak®'s unique design and special manufacturing techniques allow for a cable which has a diameter reduction of more than 15 percent relative to standard AEIC solid dielectric cable yet handles greater loads than the same size PILC. This is a major advantage for retrofitting into aging urban underground distribution systems. The smaller PowrPak® cable can be installed into existing ductwork...a feat not always possible with other types of PILC replacement cable.

Long-Term Reliability

PowrPak® is manufactured using state-of-the-art super-clean components, mixed with techniques that produce a homogeneous material that is the cleanest filled rubber insulation compound in the power cable industry. General Cable's manufacturing process technology allows for tight control of all dimensions. Our triple extrusion techniques control dimensional tolerances. Material handling systems for all PowrPak® material are second to none, including the use of Class 1000 and 10000 clean rooms at compounding and manufacturing plants. This assures a high degree of purity, consistency and long-term cable reliability.

PowrPak® Features

- > High ampacity
- > Reduced diameter
- > High dielectric strength
- > Low dielectric loss
- > Easy installation, splice and termination
- > Lower cost than PILC
- > More environmentally friendly than PILC
- > Available with TRXLPE insulation
- > **Now Available with Lead-Free Filled EAM Insulation**



Designed to Your Requirements

No two applications are identical, and neither are any two installations. General Cable engineers will provide a PowrPak® cable design to fit your conductor size, voltage, shield, duct size and duct clearance. Formula for calculating duct clearance:

$$\text{Clearance} = \frac{D}{2} - 1.366 (d) + \frac{D-d}{2} \sqrt{1 - \left(\frac{d}{D-d}\right)^2}$$

Where: D = Inside diameter of duct (inches)

d = Max. diameter of one conductor (inches)



It's Time for PowrPak®

General Cable has proven itself as a pioneer and innovator in the cable industry. PowrPak® is one example of how we think ahead and anticipate the changing needs of the electric utility industry. Since 1989, utility companies have installed millions of feet of PowrPak® cable provided by General Cable.

Cumulative PowrPak® Usage

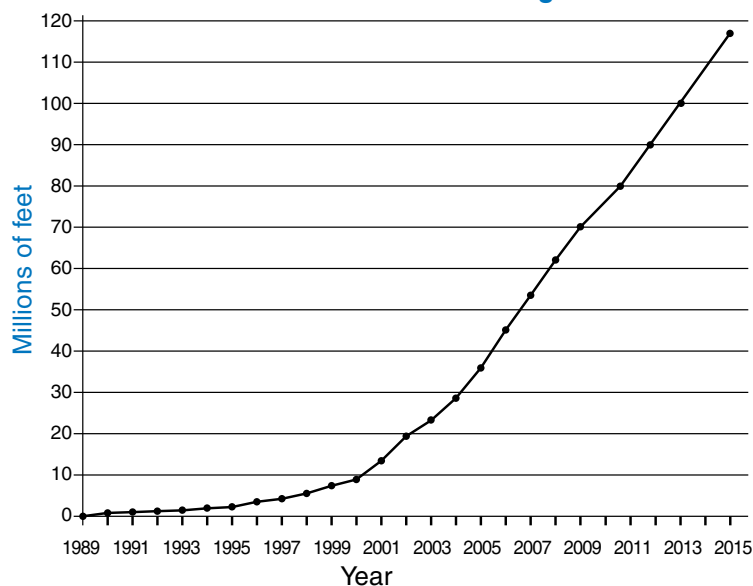

PowrPak® Underground PILC Replacement Cable

Copper EPR Insulation Flat Strap Concentric Neutral LLDPE Jacket

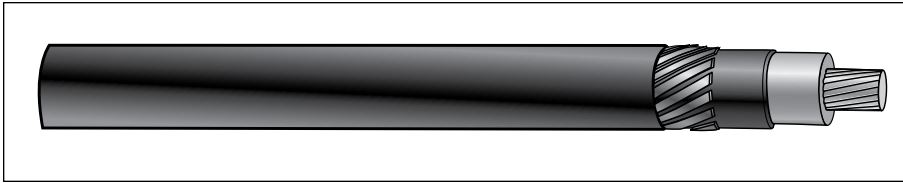

PILC REPLACEMENT CABLE – 15 kV – PowrPak®

COMPACT CONDUCTOR		FLAT STRAP SHIELD (1)				NOMINAL O.D. (INCHES)				NOM. JACKET THKN. (INCHES)	APPROX. WEIGHT (LB/1000 FT)			DUCT CLEARANCE (3)	
CU (AWG OR kcmil)	MIN. NO. OF WIRES	NO. OF STRAPS	THKN. (mils)	WIDTH (mils)	INS. (± 25 mils)	INS. SHIELD (± 30 mils)	FLAT STRAP	ENCAP JACKET (± 50 mils)	CU COND.		CU SHIELD	TOTAL	AMP. IN DUCT (2)	DUCT I.D. (INCHES)	MIN. CLEAR (INCHES)

175 mils NOMINAL EPR INSULATION – 100% INSULATION LEVEL

4/0	18	12	20	175	0.865	0.925	0.965	1.065	0.050	653	178	1167	305	3.0	0.72
350	35	14	20	175	1.006	1.066	1.106	1.206	0.050	1081	208	1694	400	3.0	0.36
500	35	14	20	175	1.126	1.186	1.226	1.326	0.050	1544	208	2222	495	3.5	0.63
750	58	16	20	175	1.298	1.358	1.398	1.498	0.050	2316	237	3120	615	4.0	0.75
1000	58	16	20	175	1.450	1.510	1.550	1.650	0.050	3088	237	3980	705	4.0	0.36

PILC REPLACEMENT CABLE – 25 kV – PowrPak®

COMPACT CONDUCTOR		FLAT STRAP SHIELD (1)				NOMINAL O.D. (INCHES)				NOM. JACKET THKN. (INCHES)	APPROX. WEIGHT (LB/1000 FT)			DUCT CLEARANCE (3)	
CU (AWG OR kcmil)	MIN. NO. OF WIRES	NO. OF STRAPS	THKN. (mils)	WIDTH (mils)	INS. (± 25 mils)	INS. SHIELD (± 30 mils)	FLAT STRAP	ENCAP JACKET (± 50 mils)	CU COND.		CU SHIELD	TOTAL	AMP. IN DUCT (2)	DUCT I.D. (INCHES)	MIN. CLEAR (INCHES)

260 mils NOMINAL EPR INSULATION – 100% INSULATION LEVEL

4/0	18	12	20	175	1.035	1.095	1.135	1.235	0.050	653	179	1319	315	3.5	0.86
350	35	14	20	175	1.176	1.236	1.276	1.376	0.050	1081	208	1866	410	3.5	0.50
500	35	14	20	175	1.296	1.356	1.396	1.496	0.050	1544	208	2409	505	4.0	0.76
750	58	16	20	175	1.468	1.528	1.568	1.668	0.050	2316	238	3331	620	4.0	0.31
1000	58	16	20	175	1.620	1.680	1.720	1.820	0.050	3088	238	4211	730	5.0	1.15

(1) Concentric neutral designs shown are for typical metallic shield requirements. The concentric neutral can be designed to fit the customer's fault current and time duration requirements. See fault current capability of typical designs on following page.

(2) Ampacity based on three phases in a duct and one duct load in the duct bank. Concrete thermal resistivity of 85°C-cm/watt, earth thermal resistivity of 90°C-cm/watt, burial depth to top of duct bank is 30", 90°C conductor temperature, 20°C earth ambient temperature and 75% load factor.

(3) Duct clearance based on maximum cable diameter and inside diameter of schedule 40 duct. Dimensions and weights not designated minimum or maximum are nominal values and subject to manufacturing tolerances. In this context, weight means mass.

Product Construction:

Complete Cable:

Cross-linked semi-conducting conductor shield, insulation and semi-conducting insulation shield are extruded over stranded copper conductor and cured in a single operation. Uncoated copper flat strap neutrals (helically applied) and extruded-to-fill black jacket are applied over the cable core.

Conductor:

STRANDFILL® compact, Class B concentric lay stranded copper meeting the requirements of ANSI/ICEA S-94-649 and tested in accordance with ICEA T-31-610.

Conductor Shield:

Extruded semi-conducting thermosetting polymeric stress control layer.

Insulation:

Extruded Ethylene Propylene Rubber (EPR) Class II and III as defined in ANSI/ICEA S-94-649.

Insulation Shield:

Extruded semi-conducting thermosetting layer, clean- and free-stripping from insulation.

Metallic Shield:

Bare annealed copper flat strap neutrals designed to meet customer fault current requirements.

Jacket:

Black, non-conducting Linear Low-Density Polyethylene (LLDPE) extruded to fill spaces between flat straps.

Features and Benefits:

- Triple-extruded for clean interfaces
- Class 10,000 environment utilized for material handling
- Flexibility for easy handling
- Excellent moisture resistance
- Improved temperature rating over PILC
- Low dielectric loss
- Deformation-resistant
- High dielectric strength
- Excellent resistance to treeing
- Clean-stripping insulation shield without the use of a release agent
- Reduced overall diameter for tight duct applications without reducing insulation wall
- No environmental concerns
- Higher emergency ampacity capabilities
- Less costly than PILC
- Millions of feet successfully installed and operated since its introduction in 1989

PowrPak® Underground PILC Replacement Cable

Copper EPR Insulation Flat Strap Concentric Neutral LLDPE Jacket

Temperature Rating:

- Normal 105°C
- Emergency* 140°C
- Short Circuit 250°C

* Operation at the emergency overload temperature shall not exceed 1500 hours cumulative during the lifetime of the cable.

Standards and Specifications:

PowrPak® cables meet the latest ANSI/ICEA S-94-649 and AEIC CS8 specifications for Ethylene Propylene Rubber (EPR) insulated concentric neutral cable except for dimensional requirements.

Applications:

PowrPak® cables are intended for use in dry or wet locations for today's aging and expanding urban underground distribution systems of utilities where PILC has been used previously. It is specifically designed to be used in urban underground network systems where existing duct space is limited.

Options:

- Class C copper conductors
- Reduced insulation wall thickness
- BIFILL® blocked conductor and cable core/jacket. Tested in accordance with ICEA T-34-664
- Available with lead-free EAM insulation
- Dry nitrogen cure
- Red stripes on jacket
- Deformation-resistant polypropylene jacket
- 3 X 1/C triplex or parallel
- CSA C68.5

For information on conductor sizes or voltage ratings not shown in the tables, contact your General Cable sales representative or e-mail infoca@generalcable.com.

FAULT CURRENT CAPABILITY OF FLAT STRAP NEUTRAL

NO. STRAPS	THKN. (mils)	WIDTH (mils)	CROSS-SECTIONAL AREA (kcmil)	AMPERES FOR FAULT DURATION (CYCLES)						
				3	6	8	10	12	15	20
12	20	175	53.466	15,064	10,652	9,225	8,251	7,532	6,737	5,834
14	20	175	62.377	17,574	12,427	10,762	9,626	8,787	7,850	6,807
16	20	175	71.288	20,085	14,202	12,300	11,001	10,043	8,982	7,779
14	25	175	77.971	21,968	15,534	13,453	12,032	10,984	9,824	8,508
16	25	175	89.110	25,106	17,753	15,374	13,751	12,553	11,228	9,724
14	35	200	124.754	35,149	24,854	21,524	19,252	17,574	15,719	13,613

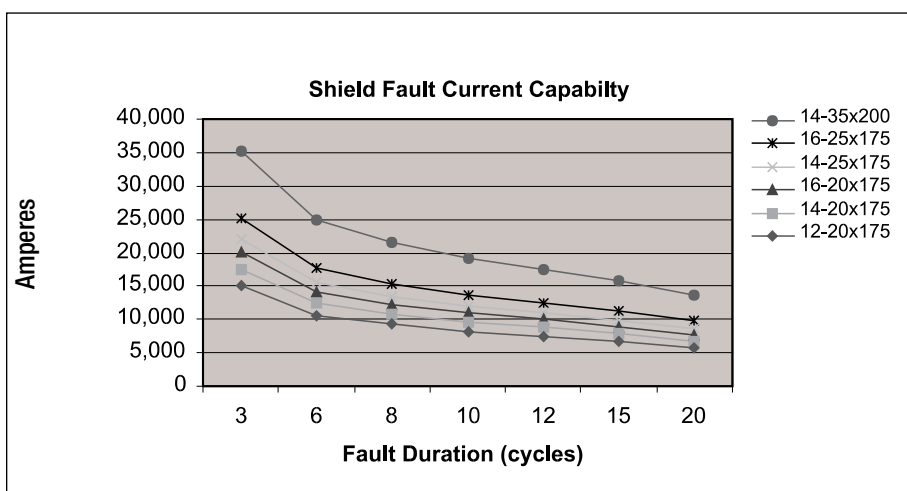

EmPowr® Link Shielded Power Cable 5-46 kV

Copper Conductor TRXLPE Insulation Copper Tape Shielded Power Cable



COPPER CONDUCTOR COPPER TAPE SHIELDED 5 kV POWER CABLE

COMPACT CONDUCTOR		DIAMETER (2) (mm)				NOM. JACKET THKN. (2) (mm)	APPROX. WEIGHT (kg/km)			AMPACITY (3)	
SIZE (AWG OR kcmil)	NO. OF WIRES (1)	INS.	INS. SHIELD	CU TAPE	PVC JACKET		CU COND.	CU SHIELD	TOTAL	DIRECT BURIED	IN DUCT
2.29 mm (90 mils) NOMINAL TRXLPE INSULATION – 5 kV 100% or 133%											
2	7	12.3	13.8	14.0	17.3	1.7	305	31	553	230	200
1	19	13.1	14.6	14.8	18.1	1.7	385	33	646	265	225
1/0	19	14.0	15.5	15.7	19.0	1.7	485	35	766	300	260
2/0	19	15.0	16.6	16.7	20.0	1.7	612	38	913	340	290
3/0	19	16.2	17.8	17.9	21.2	2.0	771	40	1097	385	330
4/0	19	17.6	19.1	19.2	23.3	2.0	972	43	1358	440	375
250	37	18.9	20.4	20.6	24.6	2.0	1148	46	1565	480	420
350	37	21.3	22.9	23.0	27.1	2.0	1609	52	2078	580	510
500	37	24.4	25.9	26.1	30.1	2.0	2298	59	2834	705	620
750	61	29.0	30.5	30.6	34.7	2.0	3447	69	4091	865	770
1000	61	32.8	34.3	34.5	38.6	2.0	4596	78	5327	990	915

COPPER CONDUCTOR COPPER TAPE SHIELDED 15 kV POWER CABLE

COMPACT CONDUCTOR		DIAMETER (4) (mm)				NOM. JACKET THKN. (4) (mm)	APPROX. WEIGHT (kg/km)			AMPACITY (3)	
SIZE (AWG OR kcmil)	NO. OF WIRES (1)	INS.	INS. SHIELD	CU TAPE	PVC JACKET		CU COND.	CU SHIELD	TOTAL	DIRECT BURIED	IN DUCT
4.45 mm (175 mils) NOMINAL TRXLPE INSULATION – 15 kV 100%											
2	7	16.6	18.1	18.3	21.6	2.0	305	46	698	230	200
1	19	17.4	18.9	19.1	23.1	2.0	385	49	829	265	225
1/0	19	18.3	19.9	20.0	24.1	2.0	485	51	956	300	260
2/0	19	19.4	20.9	21.1	25.1	2.0	612	54	1112	340	290
3/0	19	20.5	22.1	22.3	26.3	2.0	771	57	1305	385	330
4/0	19	21.9	23.4	23.6	27.6	2.0	972	60	1544	440	375
250	37	23.2	24.7	24.9	29.0	2.0	1148	63	1759	480	420
350	37	25.7	27.2	27.4	31.4	2.0	1609	70	2289	580	510
500	37	28.7	30.2	30.4	34.5	2.0	2298	77	3065	705	620
750	61	33.3	34.8	35.0	39.0	2.0	3447	89	4351	865	770
1000	61	37.1	38.7	38.8	42.9	2.0	4596	99	5612	990	915

5.59 mm (220 mils) NOMINAL TRXLPE INSULATION – 15 kV 133%

2	7	18.9	20.4	20.6	24.6	2.0	305	52	818	230	200
1	19	19.7	21.2	21.4	25.5	2.0	385	54	921	265	225
1/0	19	20.6	22.1	22.3	26.4	2.0	485	57	1051	300	260
2/0	19	21.6	23.2	23.3	27.4	2.0	612	59	1209	340	290
3/0	19	22.8	24.4	24.5	28.6	2.0	771	62	1407	385	330
4/0	19	24.2	25.7	25.9	29.9	2.0	972	66	1650	440	375
250	37	25.5	29.1	29.2	33.4	2.0	1148	74	1974	480	420
350	37	27.9	31.5	31.7	35.7	2.0	1609	81	2519	580	510
500	37	31.0	32.5	32.7	36.8	2.0	2298	83	3193	705	620
750	61	35.6	37.1	37.3	41.3	2.0	3447	95	4495	865	770
1000	61	39.4	40.9	41.1	46.7	2.8	4596	105	5901	990	915

(1) For compact stranded constructions, the number of wires may be reduced as follows:

- 19-Wire Constructions – 18 Wires Minimum
- 37-Wire Constructions – 35 Wires Minimum
- 61-Wire Constructions – 58 Wires Minimum

(2) Extruded layer thicknesses are in accordance with CSA C68.10 for Shielded Power Cable for Commercial and Industrial Applications, 5-46 kV.

(3) Ampacities based on earth thermal resistivity of 90°C-cm/watt, 90°C conductor temperature, 25°C earth ambient temperature, 75% load factor, and 36" depth of burial. Values based on one three phase circuit, one conductor per phase, in flat adjacent configuration with neutral wires bonded at each end. Ducts sized for 40% fill. For specific ampacities, contact your General Cable sales representative.

(4) Extruded layer thicknesses are in accordance with CSA C68.5 for Primary Shielded and Concentric Neutral Cable for Distribution Utilities.

Dimensions and weights not designated minimum or maximum are nominal values and subject to manufacturing tolerances. In this context, weight means mass.

Product Construction:

Complete Cable:

Cross-linked semi-conducting conductor shield, insulation and semi-conducting insulation shield are extruded over a solid or stranded aluminum or copper conductor and cured in a single operation. An uncoated copper tape (helically applied), polyester separator tape and extruded black PVC jacket are applied over the cable core.

Conductor:

Class B concentric lay stranded compact annealed uncoated copper or compact 3/4 to full hard 1350 aluminum (all sizes). The stranded conductors are longitudinally water blocked (STRANDFILL®) and tested in accordance with ICEA T-31-610.

Conductor Shield:

Extruded semi-conducting thermosetting polymeric stress control layer.

Insulation:

Extruded, unfilled Tree Retardant Cross-linked Polyethylene (TRXLPE) as defined in CSA C68.5 and CSA C68.10.

Insulation Shield:

Extruded semi-conducting thermosetting layer, clean and free stripping from insulation.

Metallic Shield:

Flat uncoated helically applied 3.0 mil thick overlapped copper tape.

Jacket:

Black, non-conducting, sunlight-resistant, FT1, low-temperature PVC.

Features and Benefits:

- CSA C68.5 for 15-46 kV
- CSA C68.10 for 5 kV
- 90°C/-40°C (LTGG)
- Triple extruded for clean interfaces
- Dry nitrogen cure for enhanced performance
- Class 10,000 environment utilized for material handling
- Excellent moisture resistance
- High dielectric strength
- Low dielectric loss
- Excellent resistance to treeing
- Clean stripping insulation shield
- Sequential meter marking
- Sunlight-resistant



EmPowr® Link Shielded Power Cable 5-46 kV

Aluminum Conductor TRXLPE Insulation Copper Tape Shielded Power Cable

Temperature Rating:

- Normal..... 90°C
- Emergency* 130°C
- Short Circuit..... 250°C

*Operation at the emergency overload temperature shall not exceed 1500 hours cumulative during the lifetime of the cable.

Specifications:

General Cable utility products copper tape shielded power cables meet the latest requirements of CSA C68.5 and CSA C68.10 as applicable for Tree Retardant Cross-linked Polyethylene (TRXLPE) insulated shielded power cable.

Applications:

EmPowr® Link cables are intended for use in dry or wet locations for distribution of three phase medium voltage power. These cables may be installed in ducts or direct buried.

Options:

- UltraPowr® smoother and cleaner semi-conducting conductor shield
- Low strip insulation shield
- Available with EPR insulation
- Available with lead-free EAM insulation
- Available with 5 mil copper tape thickness
- Available with double copper tape construction
- Available in metric (mm²) conductor sizes
- Combined Duct & Cable
- 3 X 1/C triplex or parallel assembly
- TRXLPE Class III insulation for 105°C/140°C temperature rating
- UL Listed
- AEIC CS8
- 100% pellet inspection

For more information, or information on conductor sizes or voltage ratings not shown in the tables, contact your General Cable sales representative or e-mail infoca@generalcable.com.

ALUMINUM CONDUCTOR COPPER TAPE SHIELDED 5 kV POWER CABLE											
COMPACT CONDUCTOR		DIAMETER (2) (mm)				NOM. JACKET THKN. (2) (mm)	APPROX. WEIGHT (kg/km)			AMPACITY (3)	
SIZE (AWG OR kcmil)	NO. OF WIRES (1)	INS.	INS. SHIELD	CU TAPE	PVC JACKET		AL COND.	CU SHIELD	TOTAL	DIRECT BURIED	IN DUCT

2.29 mm (90 mils) NOMINAL TRXLPE INSULATION – 5 kV 100% or 133%

2	7	12.3	13.8	14.0	17.3	1.7	93	31	341	165	125
1	19	13.1	14.6	14.8	18.1	1.7	117	33	379	190	145
1/0	19	14.0	15.5	15.7	19.0	1.7	147	35	428	215	165
2/0	19	15.0	16.6	16.7	20.0	1.7	186	38	488	245	185
3/0	19	16.2	17.8	17.9	21.2	2.0	235	40	561	280	210
4/0	19	17.6	19.1	19.2	23.3	2.0	296	43	683	320	240
250	37	18.9	20.4	20.6	24.6	2.0	349	46	765	350	275
350	37	21.3	22.9	23.0	27.1	2.0	490	52	959	425	330
500	37	24.4	25.9	26.1	30.1	2.0	697	59	1234	520	405
750	61	29.0	30.5	30.6	34.7	2.0	1047	69	1691	655	510
1000	61	32.8	34.3	34.5	38.6	2.0	1394	78	2125	760	610

ALUMINUM CONDUCTOR COPPER TAPE SHIELDED 15 kV POWER CABLE											
COMPACT CONDUCTOR		DIAMETER (4) (mm)				NOM. JACKET THKN. (4) (mm)	APPROX. WEIGHT (kg/km)			AMPACITY (3)	
SIZE (AWG OR kcmil)	NO. OF WIRES (1)	INS.	INS. SHIELD	CU TAPE	PVC JACKET		AL COND.	CU SHIELD	TOTAL	DIRECT BURIED	IN DUCT

4.45 mm (175 mils) NOMINAL TRXLPE INSULATION – 15 kV 100%

2	7	16.6	18.1	18.3	21.6	2.0	93	47	485	165	125
1	19	17.4	18.9	19.1	23.2	2.0	117	49	562	190	145
1/0	19	18.3	19.9	20.0	24.1	2.0	147	51	619	215	165
2/0	19	19.4	20.9	21.1	25.1	2.0	186	54	686	245	185
3/0	19	20.5	22.1	22.3	26.3	2.0	235	57	769	280	210
4/0	19	21.9	23.4	23.6	27.6	2.0	296	60	868	320	240
250	37	23.2	24.7	24.9	29.0	2.0	349	63	959	350	275
350	37	25.7	27.2	27.4	31.4	2.0	490	70	1170	425	330
500	37	28.7	30.2	30.4	34.5	2.0	697	77	1464	520	405
750	61	33.3	34.8	35.0	39.0	2.0	1047	89	1951	655	510
1000	61	37.1	38.7	38.8	42.9	2.0	1394	99	2410	760	610

5.59 mm (220 mils) NOMINAL TRXLPE INSULATION – 15 kV 133%

2	7	18.9	20.4	20.6	24.7	2.0	93	52	606	165	125
1	19	19.7	21.2	21.4	25.5	2.0	117	54	653	190	145
1/0	19	20.6	22.1	22.3	26.4	2.0	147	57	713	215	165
2/0	19	21.6	23.2	23.3	27.4	2.0	186	59	784	245	185
3/0	19	22.8	24.4	24.5	28.6	2.0	235	62	871	280	210
4/0	19	24.2	25.7	28.9	29.9	2.0	296	66	974	320	240
250	37	25.5	27.0	27.2	31.3	2.0	349	69	1070	350	275
350	37	27.9	29.5	29.6	33.7	2.0	490	76	1288	425	330
500	37	31.0	32.5	32.7	36.7	2.0	697	83	1592	520	405
750	61	35.6	37.1	37.3	41.3	2.0	1047	95	2094	655	510
1000	61	39.4	40.9	41.1	46.7	2.8	1394	105	2700	760	610

(1) For compact stranded constructions, the number of wires may be reduced as follows:
 19-Wire Constructions – 18 Wires Minimum
 37-Wire Constructions – 35 Wires Minimum
 61-Wire Constructions – 58 Wires Minimum

(2) Extruded layer thicknesses are in accordance with CSA C68.10 for Shielded Power Cable for Commercial and Industrial Applications, 5-46 kV.

(3) Ampacities based on earth thermal resistivity of 90°C-cm/watt, 90°C conductor temperature, 25°C earth ambient temperature, 75% load factor, and 36" depth of burial. Values based on one three phase circuit, one conductor per phase, in flat adjacent configuration with neutral wires bonded at each end. Ducts sized for 40% fill. For specific ampacities, contact your General Cable sales representative.

(4) Extruded layer thicknesses are in accordance with CSA C68.5 for Primary Shielded and Concentric Neutral Cable for Distribution Utilities.

Dimensions and weights not designated minimum or maximum are nominal values and subject to manufacturing tolerances. In this context, weight means mass.



EmPowr® Link Shielded Power Cable 5-46 kV

Copper Conductor TRXLPE Insulation Copper Tape Shielded Power Cable

COPPER CONDUCTOR COPPER TAPE SHIELDED 25 kV POWER CABLE											
COMPACT CONDUCTOR		DIAMETER (2) (mm)				NOM. JACKET THKN. (2) (mm)	APPROX. WEIGHT (kg/km)			AMPACITY (3)	
SIZE (AWG OR kcmil)	NO. OF WIRES (1)	INS.	INS. SHIELD	CU TAPE	PVC JACKET		CU COND.	CU SHIELD	TOTAL	DIRECT BURIED	IN DUCT
6.60 mm (260 mils) NOMINAL TRXLPE INSULATION – 25 kV 100%											
1	19	21.7	23.2	23.4	27.5	2.0	385	60	1008	255	225
1/0	19	22.7	24.2	24.4	28.4	2.0	485	62	1141	290	255
2/0	19	23.7	25.2	25.4	29.4	2.0	612	65	1302	330	290
3/0	19	24.9	26.4	26.6	30.6	2.0	771	68	1503	380	325
4/0	19	26.2	27.7	27.9	32.0	2.0	972	71	1750	430	370
250	37	27.5	29.1	29.2	33.3	2.0	1148	74	1974	475	420
350	37	30.0	31.5	31.7	35.7	2.0	1609	81	2519	570	505
500	37	33.0	34.5	34.7	38.8	2.0	2298	89	3314	690	610
750	61	37.6	39.1	39.3	43.4	2.8	3447	100	4629	855	755
1000	61	41.5	43.0	43.2	48.7	2.8	4596	110	6052	985	900

COPPER CONDUCTOR COPPER TAPE SHIELDED 35 kV POWER CABLE											
COMPACT CONDUCTOR		DIAMETER (2) (mm)				NOM. JACKET THKN. (2) (mm)	APPROX. WEIGHT (kg/km)			AMPACITY (3)	
SIZE (AWG OR kcmil)	NO. OF WIRES (1)	INS.	INS. SHIELD	CU TAPE	PVC JACKET		CU COND.	CU SHIELD	TOTAL	DIRECT BURIED	IN DUCT
8.76 mm (345 mils) NOMINAL TRXLPE INSULATION – 35 kV 100%											
1/0	19	27.0	28.5	28.7	32.7	2.0	485	73	1352	290	255
2/0	19	28.0	29.5	29.7	33.8	2.0	612	76	1520	330	290
3/0	19	29.2	30.7	30.9	35.0	2.0	771	79	1729	380	330
4/0	19	30.5	32.0	32.2	36.3	2.0	972	82	1984	430	375
250	37	31.8	33.4	33.6	37.6	2.0	1148	86	2216	475	420
350	37	34.3	35.8	36.0	40.1	2.0	1609	92	2776	570	505
500	37	37.3	38.9	39.0	43.1	2.0	2298	99	3590	690	610
750	61	41.9	43.4	43.6	49.2	2.8	3447	111	5073	855	755
1000	61	45.8	47.3	47.5	53.1	2.8	4596	121	6394	985	890

COPPER CONDUCTOR COPPER TAPE SHIELDED 46 kV POWER CABLE											
COMPACT CONDUCTOR		DIAMETER (2) (mm)				NOM. JACKET THKN. (2) (mm)	APPROX. WEIGHT (kg/km)			AMPACITY (3)	
SIZE (AWG OR kcmil)	NO. OF WIRES (1)	INS.	INS. SHIELD	CU TAPE	PVC JACKET		CU COND.	CU SHIELD	TOTAL	DIRECT BURIED	IN DUCT
11.3 mm (445 mils) NOMINAL TRXLPE INSULATION – 46 kV 100%											
4/0	19	35.6	37.1	37.3	41.4	2.0	972	95	2293	425	370
250	37	36.9	38.5	38.6	42.7	2.8	1148	98	2535	470	415
350	37	39.4	40.9	41.1	46.7	2.8	1609	105	3245	565	500
500	37	42.4	43.9	44.1	49.7	2.8	2298	112	4091	685	605
750	61	47.0	48.5	48.7	54.3	2.8	3447	124	5481	850	750
1000	61	50.9	52.4	52.6	58.1	2.8	4596	134	6829	980	885

(1) For compact stranded constructions, the number of wires may be reduced as follows:

- 19-Wire Constructions – 18 Wires Minimum
- 37-Wire Constructions – 35 Wires Minimum
- 61-Wire Constructions – 58 Wires Minimum

(2) Extruded layer thicknesses are in accordance with CSA C68.5 for Primary Shielded and Concentric Neutral Cable for Distribution Utilities.

(3) Ampacities based on earth thermal resistivity of 90°C-cm/watt, 90°C conductor temperature, 25°C earth ambient temperature, 75% load factor, and 36" depth of burial. Values based on one three phase circuit, one conductor per phase, in flat adjacent configuration with neutral wires bonded at each end. Ducts sized for 40% fill. For specific ampacities, contact your General Cable sales representative.

Dimensions and weights not designated minimum or maximum are nominal values and subject to manufacturing tolerances. In this context, weight means mass.



EmPowr® Link Shielded Power Cable 5-46 kV

Aluminum Conductor TRXLPE Insulation Copper Tape Shielded Power Cable

ALUMINUM CONDUCTOR COPPER TAPE SHIELDED 25 kV POWER CABLE

COMPACT CONDUCTOR		DIAMETER (2) (mm)				NOM. JACKET THKN. (2) (mm)	APPROX. WEIGHT (kg/km)			AMPACITY (3)	
SIZE (AWG OR kcmil)	NO. OF WIRES (1)	INS.	INS. SHIELD	CU TAPE	PVC JACKET		AL COND.	CU SHIELD	TOTAL	DIRECT BURIED	IN DUCT

6.60 mm (260 mils) NOMINAL TRXLPE INSULATION – 25 kV 100%

1	19	21.7	23.2	23.4	27.5	2.0	117	60	740	185	145
1/0	19	22.7	24.2	24.4	28.4	2.0	147	62	803	215	165
2/0	19	23.7	25.2	25.4	29.4	2.0	186	65	877	245	185
3/0	19	24.9	26.4	26.6	30.6	2.0	235	68	966	275	215
4/0	19	26.2	27.7	27.9	32.0	2.0	296	71	1075	315	250
250	37	27.5	29.1	29.2	33.3	2.0	349	74	1174	350	275
350	37	30.0	31.5	31.7	35.7	2.0	490	81	1400	420	335
500	37	33.0	34.5	34.7	38.8	2.0	697	89	1713	515	405
750	61	37.6	39.1	39.3	43.4	2.8	1047	100	2228	650	520
1000	61	41.5	43.0	43.2	48.7	2.8	1394	110	2851	755	605

ALUMINUM CONDUCTOR COPPER TAPE SHIELDED 35 kV POWER CABLE

COMPACT CONDUCTOR		DIAMETER (2) (mm)				NOM. JACKET THKN. (2) (mm)	APPROX. WEIGHT (kg/km)			AMPACITY (3)	
SIZE (AWG OR kcmil)	NO. OF WIRES (1)	INS.	INS. SHIELD	CU TAPE	PVC JACKET		AL COND.	CU SHIELD	TOTAL	DIRECT BURIED	IN DUCT

8.76 mm (345 mils) NOMINAL TRXLPE INSULATION – 35 kV 100%

1/0	19	27.0	28.5	28.7	32.7	2.0	147	73	1014	210	170
2/0	19	28.0	29.5	29.7	33.8	2.0	186	76	1095	240	190
3/0	19	29.2	30.7	30.9	35.0	2.0	235	79	1193	275	220
4/0	19	30.5	32.0	32.2	36.3	2.0	296	82	1308	310	250
250	37	31.8	33.4	33.6	37.6	2.0	349	86	1416	345	275
350	37	34.3	25.8	36.0	40.1	2.0	490	92	1657	415	340
500	37	37.3	38.9	39.0	43.1	2.0	697	100	1989	510	410
750	61	41.9	43.4	43.6	49.1	2.8	1047	111	2673	640	525
1000	61	45.8	47.3	47.5	53.1	2.8	1394	121	3192	745	615

ALUMINUM CONDUCTOR COPPER TAPE SHIELDED 46 kV POWER CABLE

COMPACT CONDUCTOR		DIAMETER (2) (mm)				NOM. JACKET THKN. (2) (mm)	APPROX. WEIGHT (kg/km)			AMPACITY (3)	
SIZE (AWG OR kcmil)	NO. OF WIRES (1)	INS.	INS. SHIELD	CU TAPE	PVC JACKET		AL COND.	CU SHIELD	TOTAL	DIRECT BURIED	IN DUCT

11.3 mm (445 mils) NOMINAL TRXLPE INSULATION – 46 kV 100%

250	37	36.9	38.5	38.6	42.7	2.8	349	98	1735	345	275
350	37	39.4	40.9	41.1	46.7	2.8	490	105	2126	415	340
500	37	42.4	43.9	44.1	49.7	2.8	697	113	2490	510	410
750	61	47.0	48.5	48.7	54.3	2.8	1047	124	3081	640	525
1000	61	50.9	52.4	52.6	58.1	2.8	1394	134	3628	745	615

(1) For compact stranded constructions, the number of wires may be reduced as follows:

- 19-Wire Constructions – 18 Wires Minimum
- 37-Wire Constructions – 35 Wires Minimum
- 61-Wire Constructions – 58 Wires Minimum

(2) Extruded layer thicknesses are in accordance with CSA C68.5 for Primary Shielded and Concentric Neutral Cable for Distribution Utilities.

(3) Ampacities based on earth thermal resistivity of 90°C-cm/watt, 90°C conductor temperature, 20°C earth ambient temperature, 75% load factor, and 36" depth of burial. Values based on one three phase circuit, one conductor per phase, in flat adjacent configuration with neutral wires bonded at each end. Ducts sized for 40% fill. For specific ampacities, contact your General Cable sales representative.

Dimensions and weights not designated minimum or maximum are nominal values and subject to manufacturing tolerances. In this context, weight means mass.



EmPowr® Link Shielded Power Cable 15-46 kV

CU Conductor TRXLPE Insulation Longitudinally Applied Corrugated Tape LLDPE Jacket

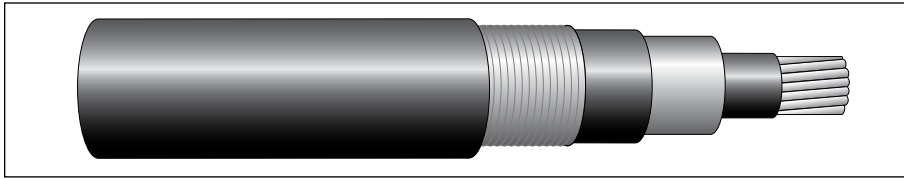

COPPER CONDUCTOR LONGITUDINALLY APPLIED CORRUGATED TAPE SHIELDED 15 kV POWER CABLE

COMPACT CONDUCTOR		DIAMETER (2) (mm)				NOM. JACKET THKN. (2) (mm)	APPROX. WEIGHT (kg/km)			AMPACITY (3)	
SIZE (AWG OR kcmil)	NO. OF WIRES (1)	INS.	LACT SHIELD THKN.	O.D.	LLDPE JACKET		CU COND.	CU SHIELD	TOTAL	DIRECT BURIED	IN DUCT

4.45 mm (175 mils) NOMINAL TRXLPE INSULATION – 15 kV 100% LEVEL

250	37	23.2	0.203	27.0	31.1	2.0	1149	196	1889	475	420
250	37	23.2	0.254	27.2	31.2	2.0	1149	245	1939	475	420
350	37	25.7	0.203	29.5	33.5	2.0	1609	208	2424	575	505
350	37	25.7	0.254	29.6	33.7	2.0	1609	284	2500	575	505
500	37	28.7	0.203	32.5	36.6	2.0	2298	233	3215	695	615
500	37	28.7	0.254	32.7	36.7	2.0	2298	284	3268	695	615
750	61	33.3	0.203	37.4	41.5	2.0	3447	275	4541	855	760
750	61	33.3	0.254	37.6	41.7	2.0	3447	344	4611	855	760
1000	61	37.1	0.203	41.3	46.9	2.8	4596	303	5921	980	905
1000	61	37.1	0.254	41.5	47.0	2.8	4596	379	5999	980	905

5.59 mm (220 mils) NOMINAL TRXLPE INSULATION – 15 kV 133% LEVEL

250	37	25.5	0.203	29.3	33.4	2.0	1149	208	2005	475	420
250	37	25.5	0.254	29.5	33.5	2.0	1149	284	2081	475	420
350	37	27.9	0.203	31.8	35.8	2.0	1609	233	2560	575	505
350	37	27.9	0.254	31.9	36.0	2.0	1609	284	2612	575	505
500	37	31.0	0.203	34.8	38.9	2.0	2298	240	3344	695	615
500	37	31.0	0.254	35.3	39.4	2.0	2298	327	3442	695	615
750	61	35.6	0.203	39.7	45.3	2.8	3447	296	4798	855	760
750	61	35.6	0.254	39.9	45.5	2.8	3447	370	4874	855	760
1000	61	39.4	0.203	43.6	49.2	2.8	4596	317	6090	980	905
1000	61	39.4	0.254	43.7	49.3	2.8	4596	396	6171	980	905

(1) For compact stranded constructions, the number of wires may be reduced as follows:

- 19-Wire Constructions – 18 Wires Minimum
- 37-Wire Constructions – 35 Wires Minimum
- 61-Wire Constructions – 58 Wires Minimum

(2) Extruded layer thicknesses are in accordance with CSA C68.5 for Primary Shielded and Concentric Neutral Cable for Distribution Utilities.

(3) Ampacities based on earth thermal resistivity of 90°C-cm/watt, 90°C conductor temperature, 20°C earth ambient temperature, 75% load factor, and 36" depth of burial. Values based on one three phase circuit, one conductor per phase, in flat adjacent configuration with neutral wires bonded at each end. Ducts sized for 40% fill. For specific ampacities, contact your General Cable sales representative.

Dimensions and weights not designated minimum or maximum are nominal values and subject to manufacturing tolerances. In this context, weight means mass.

Product Construction:

Complete Cable:

Cross-linked semi-conducting conductor shield, insulation and semi-conducting insulation shield are extruded over an aluminum or copper conductor and cured in a single operation. Corrugated copper tape and an extruded black jacket are applied over the cable core.

Conductor:

Class B concentric lay stranded compact annealed uncoated copper or compact 3/4 to full hard 1350 aluminum (all sizes). The stranded conductors are longitudinally water blocked (STRANDFILL®) and tested in accordance with ICEA T-31-610.

Conductor Shield:

Extruded semi-conducting thermosetting polymeric stress control layer.

Insulation:

Extruded, unfilled Tree-Retardant Cross-linked Polyethylene (TRXLPE) as defined in CSA C68.5.

Insulation Shield:

Extruded semi-conducting thermosetting layer, clean- and free-stripping from insulation.

Metallic Shield:

Copper, 8 or 10 mil thick Longitudinally Applied Corrugated Tape (LACT) with a minimum 375 mil overlap.

Jacket:

Black, non-conducting, sunlight-resistant Linear Low-Density Polyethylene (LLDPE). Three extruded red stripes are incorporated into the cable jacket to provide visual identification of a jacketed power cable.

Features and Benefits:

- Even distribution of fault current and better heat dissipation
- Allows expansion/contraction of the cable core
- Improved bending characteristics versus helical copper tape shield
- Triple-extruded for clean interfaces
- Class 10,000 environment utilized for material handling
- Excellent moisture resistance
- High dielectric strength
- Low dielectric loss
- Excellent resistance to treeing
- Clean-stripping insulation shield

Temperature Rating:

- Normal.....90°C
- Emergency*130°C
- Short Circuit250°C

*Operation at the emergency overload temperature shall not exceed 1500 hours cumulative during the lifetime of the cable.



EmPowr® Link Shielded Power Cable 15-46 kV

AL Conductor TRXLPE Insulation Longitudinally Applied Corrugated Tape LLDPE Jacket

Standards and Specifications:

General Cable Electric Utility Products meet the latest requirements of CSA C68.5 as applicable for Tree-Retardant Cross-linked Polyethylene (TRXLPE) insulated shielded power cable.

Applications:

EmPowr® Link cables are intended for use in dry or wet locations for distribution of three-phase medium-voltage power. These cables may be installed in ducts or direct buried.

Options:

- BIFILL® tested to ICEA T-34-664
 1. blocked conductor
 2. blocked cable core/LACT
- Sealed LACT overlap
- Low-strip insulation shield
- Available with EPR insulation
- Available with lead-free EAM insulation
- Semi-conducting thermoplastic jacket
- 3 X 1/C triplex or parallel assembly
- TRXLPE Class III insulation for 105°/140°C temperature rating
- UL listed
- 100% pellet inspection

For information on conductor sizes or voltage ratings not shown in the tables, contact your General Cable sales representative or e-mail infoca@generalcable.com.

ALUMINUM CONDUCTOR LONGITUDINALLY APPLIED CORRUGATED TAPE SHIELDED 15 kV POWER CABLE

COMPACT CONDUCTOR		DIAMETER (2) (mm)			NOM. JACKET THKN. (2) (mm)	APPROX. WEIGHT (kg/km)			AMPACITY (3)	
SIZE (AWG OR kcmil)	NO. OF WIRES (1)	INS.	LACT SHIELD			LLDPE JACKET	AL COND.	CU SHIELD	TOTAL	DIRECT BURIED
			THKN.	O.D.						

4.45 mm (175 mils) NOMINAL TRXLPE INSULATION – 15 kV 100% LEVEL

250	37	23.2	0.203	27.0	31.1	2.0	349	196	1089	370	285
250	37	23.2	0.254	27.2	31.2	2.0	349	245	1139	370	285
350	37	25.7	0.203	29.5	33.5	2.0	490	208	1305	445	345
350	37	25.7	0.254	29.6	33.7	2.0	490	284	1380	445	345
500	37	28.7	0.203	32.5	36.6	2.0	697	233	1615	545	425
500	37	28.7	0.254	32.7	36.7	2.0	697	284	1667	545	425
750	61	33.3	0.203	37.4	41.5	2.0	1047	275	2141	665	530
750	61	33.3	0.254	37.6	41.7	2.0	1047	344	2211	665	530
1000	61	37.1	0.203	41.3	46.9	2.8	1394	303	2720	780	630
1000	61	37.1	0.254	41.5	47.0	2.8	1394	379	2798	780	630

5.59 mm (220 mils) NOMINAL TRXLPE INSULATION – 15 kV 133% LEVEL

250	37	25.5	0.203	29.3	33.4	2.0	349	208	1205	370	285
250	37	25.5	0.254	29.5	33.5	2.0	349	284	1281	370	285
350	37	27.9	0.203	31.8	35.8	2.0	490	233	1441	445	345
350	37	27.9	0.254	31.9	36.0	2.0	490	284	1493	445	345
500	37	31.0	0.203	34.8	38.9	2.0	697	240	1743	545	425
500	37	31.0	0.254	35.3	39.4	2.0	697	327	1842	545	425
750	61	35.6	0.203	39.7	45.3	2.8	1047	296	2398	665	530
750	61	35.6	0.254	39.9	45.5	2.8	1047	370	2474	665	530
1000	61	39.4	0.203	43.6	49.2	2.8	1394	330	2902	780	630
1000	61	39.4	0.254	43.7	49.3	2.8	1394	404	2978	780	630

(1) For compact stranded constructions, the number of wires may be reduced as follows:

- 19-Wire Constructions – 18 Wires Minimum
- 37-Wire Constructions – 35 Wires Minimum
- 61-Wire Constructions – 58 Wires Minimum

(2) Extruded layer thicknesses are in accordance with CSA C68.5 for Primary Shielded and Concentric Neutral Cable for Distribution Utilities.

(3) Ampacities based on earth thermal resistivity of 90°C-cm/watt, 90°C conductor temperature, 20°C earth ambient temperature, 75% load factor, and 36" depth of burial. Values based on one three phase circuit, one conductor per phase, in flat adjacent configuration with neutral wires bonded at each end. Ducts sized for 40% fill. For specific ampacities, contact your General Cable sales representative.

Dimensions and weights not designated minimum or maximum are nominal values and subject to manufacturing tolerances. In this context, weight means mass.

EmPowr® Link Shielded Power Cable 15-46 kV

CU Conductor TRXLPE Insulation Longitudinally Applied Corrugated Tape LLDPE Jacket

COPPER CONDUCTOR LONGITUDINALLY APPLIED CORRUGATED TAPE SHIELDED POWER CABLE

COMPACT CONDUCTOR		DIAMETER (2) (mm)				NOM. JACKET THKN. (2) (mm)	APPROX. WEIGHT (kg/km)			AMPACITY (3)	
SIZE (AWG OR kcmil)	NO. OF WIRES (1)	INS.	LACT SHIELD		LLDPE JACKET		CU COND.	CU SHIELD	TOTAL	DIRECT BURIED	IN DUCT
			THKN.	O.D.							
6.60 mm (260 mils) NOMINAL TRXLPE INSULATION – 25 kV 100% LEVEL											
250	37	27.5	0.203	31.3	35.4	2.0	1149	233	2128	475	420
250	37	27.5	0.254	31.5	35.6	2.0	1149	284	2180	475	420
350	37	30.0	0.203	33.8	37.9	2.0	1609	233	2666	575	505
350	37	30.0	0.254	34.3	38.4	2.0	1609	327	2770	575	505
500	37	33.0	0.203	37.2	41.3	2.0	2298	275	3504	695	615
500	37	33.0	0.254	37.3	41.4	2.0	2298	344	3575	695	615
750	61	37.6	0.203	41.8	47.4	2.8	3447	310	4945	855	760
750	61	37.6	0.254	41.9	47.5	2.8	3447	387	5024	855	760
1000	61	41.5	0.203	45.6	51.2	2.8	4596	330	6248	980	905
1000	61	41.5	0.254	45.8	51.4	2.8	4596	413	6333	980	905

8.76 mm (345 mils) NOMINAL TRXLPE INSULATION – 35 kV 100% LEVEL

250	37	31.9	0.203	36.0	40.1	2.0	1149	275	2409	475	420
250	37	31.9	0.254	36.2	40.2	2.0	1149	344	2479	475	420
350	37	34.3	0.203	38.5	42.5	2.0	1609	282	2970	570	505
350	37	34.3	0.254	38.6	42.7	2.0	1609	353	3042	570	505
500	37	37.3	0.203	41.5	47.1	2.8	2298	303	3899	700	610
500	37	37.3	0.254	41.7	47.2	2.8	2298	379	3977	700	610
750	61	41.9	0.203	46.1	51.7	2.8	3447	337	5274	865	755
750	61	41.9	0.254	46.2	51.8	2.8	3447	422	5361	865	755
1000	61	45.8	0.203	49.9	55.5	2.8	4596	365	6609	960	900
1000	61	45.8	0.254	50.1	55.7	2.8	4596	456	6702	960	900

(1) For compact stranded constructions, the number of wires may be reduced as follows:

19-Wire Constructions – 18 Wires Minimum

37-Wire Constructions – 35 Wires Minimum

61-Wire Constructions – 58 Wires Minimum

(2) Extruded layer thicknesses are in accordance with CSA C68.5 for Primary Shielded and Concentric Neutral Cable for Distribution Utilities.

(3) Ampacities based on earth thermal resistivity of 90°C-cm/watt, 90°C conductor temperature, 20°C earth ambient temperature, 75% load factor, and 36" depth of burial. Values based on one three phase circuit, one conductor per phase, in flat adjacent configuration with neutral wires bonded at each end. Ducts sized for 40% fill. For specific ampacities, contact your General Cable sales representative.

Dimensions and weights not designated minimum or maximum are nominal values and subject to manufacturing tolerances. In this context, weight means mass.



EmPowr® Link Shielded Power Cable 15-46 kV

AL Conductor TRXLPE Insulation Longitudinally Applied Corrugated Tape LLDPE Jacket

ALUMINUM CONDUCTOR LONGITUDINALLY APPLIED CORRUGATED TAPE SHIELDED POWER CABLE

COMPACT CONDUCTOR		DIAMETER (2) (mm)				NOM. JACKET THKN. (2) (mm)	APPROX. WEIGHT (kg/km)			AMPACITY (3)	
SIZE (AWG OR kcmil)	NO. OF WIRES (1)	INS.	LACT SHIELD		LLDPE JACKET		AL COND.	CU SHIELD	TOTAL	DIRECT BURIED	IN DUCT
			THKN.	O.D.							

6.60 mm (260 mils) NOMINAL TRXLPE INSULATION – 25 kV 100% LEVEL

250	37	27.5	0.203	31.3	35.4	2.0	349	233	1328	370	285
250	37	27.5	0.254	31.5	35.6	2.0	349	284	1380	370	285
350	37	30.0	0.203	33.8	37.9	2.0	490	233	1547	445	345
350	37	30.0	0.254	34.3	38.4	2.0	490	327	1651	445	345
500	37	33.0	0.203	37.2	41.3	2.0	697	275	1904	545	425
500	37	33.0	0.254	37.3	41.4	2.0	697	344	1974	545	425
750	61	37.6	0.203	41.8	47.4	2.8	1047	310	2544	665	530
750	61	37.6	0.254	41.9	47.5	2.8	1047	387	2624	665	530
1000	61	41.5	0.203	45.6	51.2	2.8	1394	337	3054	780	630
1000	61	41.5	0.254	45.8	51.4	2.8	1394	422	3140	780	630

8.76 mm (345 mils) NOMINAL TRXLPE INSULATION – 35 kV 100% LEVEL

250	37	31.9	0.203	36.0	40.1	2.0	349	275	1609	360	295
250	37	31.9	0.254	36.2	40.2	2.0	349	344	1679	360	295
350	37	34.3	0.203	38.5	42.5	2.0	490	282	1851	430	355
350	37	34.3	0.254	38.6	42.7	2.0	490	353	1923	430	355
500	37	37.3	0.203	41.5	47.1	2.8	697	303	2298	530	430
500	37	37.3	0.254	41.7	47.2	2.8	697	379	2376	530	430
750	61	41.9	0.203	46.1	51.7	2.8	1047	337	2874	650	550
750	61	41.9	0.254	46.2	51.8	2.8	1047	422	2961	650	550
1000	61	45.8	0.203	49.9	55.5	2.8	1394	365	3407	765	625
1000	61	45.8	0.254	50.1	55.7	2.8	1394	456	3501	765	625

(1) For compact stranded constructions, the number of wires may be reduced as follows:

- 19-Wire Constructions – 18 Wires Minimum
- 37-Wire Constructions – 35 Wires Minimum
- 61-Wire Constructions – 58 Wires Minimum

(2) Extruded layer thicknesses are in accordance with CSA C68.5 for Primary Shielded and Concentric Neutral Cable for Distribution Utilities.

(3) Ampacities based on earth thermal resistivity of 90°C-cm/watt, 90°C conductor temperature, 20°C earth ambient temperature, 75% load factor, and 36" depth of burial. Values based on one three phase circuit, one conductor per phase, in flat adjacent configuration with neutral wires bonded at each end. Ducts sized for 40% fill. For specific ampacities, contact your General Cable sales representative.

Dimensions and weights not designated minimum or maximum are nominal values and subject to manufacturing tolerances. In this context, weight means mass.



Notes

High- and Extra-High-Voltage Transmission Cable

RELY ON OUR EXPERIENCE... EXPERIENCE OUR CAPABILITIES



For over half a century, the Silec brand name has been a recognized leader in the global electric utility market. With unrivaled capabilities, expertise and turnkey project management, General Cable provides the innovation, quality and service to reliably and cost-effectively bring power from the grid into major urban areas. **Having pioneered the development of solid-dielectric extruded High- and Extra-High-Voltage (HV/EHV) cable systems over fifty years ago**, General Cable provides its global customers with superior cable system solutions that offer maximum flexibility and service life.

When it comes to upgrading North America's aging utility grid with underground solid-dielectric cable systems, General Cable understands the challenges that these significant and complex projects present, from system planning, engineering and project management to final testing and post-project maintenance. Underground transmission systems represent a considerable investment, requiring a long-term partner that has in-depth knowledge of the cables, accessories and installation methods — General Cable is that partner.

- **Decades of experience in underground solid-dielectric cable systems**
- **Comprehensive line of high- and extra-high-voltage cable and accessories**
- **Total turnkey project management, from planning through installation, testing and commissioning**
- **Optimized economics to keep projects on time and on budget**
- **Extremely reliable, low-maintenance and long-term performance**
- **Complete post-project maintenance services and responsive ongoing support**

With the best experience, the best product and the best service, General Cable is the best partner to meet your expectations.

THE WORLD LEADER FOR HV/EHV UNDERGROUND TRANSMISSION CABLE SYSTEMS UP TO 500 kV



- 63-110 kV
- 132-160 kV
- 230 kV
- 345-500 kV

Voltage level (kV)	63-161	220-230	330-500
Cable (km)	9,947	6,561	508.8
Terminations	22,612	7,432	951
Joints	11,729	6,794	547

50 Years of Worldwide High- & Extra-High-Voltage Firsts

VOLTAGE RANGE

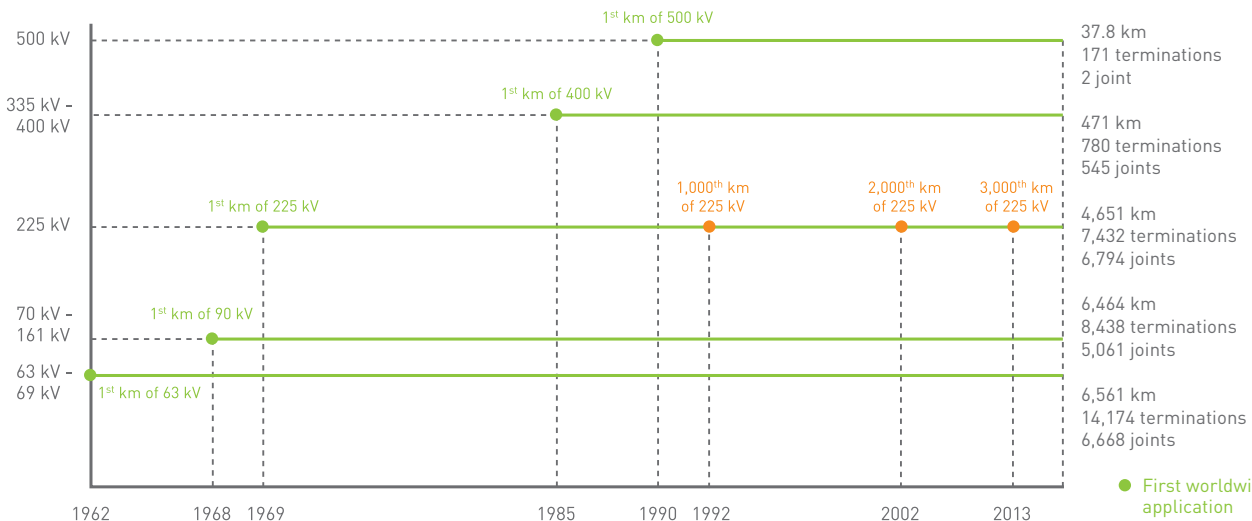

Ref. 2013



HIGH- & EXTRA-HIGH-VOLTAGE GLOBAL CABLE SOLUTIONS

The Silec brand name has been synonymous with solid-dielectric extruded cable solutions for over fifty years. General Cable offers a fully integrated approach to providing a comprehensive range of quality Silec High- and Extra-High-Voltage cable systems. They are designed, engineered and manufactured to ensure maximum reliability and best-in-class performance.

General Cable’s Silec HV/EHV underground transmission cables are manufactured to meet the needs of current and future utility transmission systems. They exceed the requirements of our customers’ technical specifications while meeting international standards like IEC 60840, IEC 60287, IEC 62067, ICEA S-108-720 and AEIC CS9.



The Most Comprehensive HV/EHV Solid-Dielectric Underground Transmission Cable Options in the Industry — Voltage Ratings up to 500 kV

- 1 Conductor**
 - Manufacturing up to 5,000 kcmil (2,500 mm²) conductor.
 - Copper, enamelled copper or aluminum stranded wires, watertight or non-watertight
 - Compact round
 - Segmental for Milliken conductor (recommended at 2,500 kcmil [1,200 mm²] and above) to achieve high ampacities
- 2 Insulation**
 - Triple-head extrusion process using super-clean Cross-linked Polyethylene (XLPE) provides high dielectric performance.
 - 2.1** Inner semi-conductive layer
 - 2.2** Insulation
 - 2.3** Outer semi-conductive layer
- 3 Longitudinal Water Barrier**
 - Swelling semi-conductive tape (under and over wirescreen or optional optical fibre tubes).
- 4 Metal Screen/ Radial Moisture Barrier**
 - Sheathing options for short circuit requirements and radial moisture barrier.
 - Concentric wires: copper or aluminum
 - Foil laminated: copper or aluminum
 - Welded or butt-to-butt welded
 - Lead sheath
- 5 Jacket**
 - Jacketing options for mechanical and chemical protection.
 - High-Density Polyethylene (HDPE)
 - Low-Density Polyethylene (LDPE) or Linear Low-Density Polyethylene (LLDPE)
 - Halogen-free fire-retardant sheathing complex
 - Fire-retardant low-smoke sheathing complex
 - Polyvinyl Chloride (PVC)
 - Conductive coating
- 6 Additional Components**
 - Proprietary µCable® fibres (single- or multimode) within a Polyethylene (PE) tube for flexibility and improved stripability are integrated into the high- or extra-high-voltage cable for temperature monitoring via DTS system
 - General Cable can also provide standard stainless steel tube with single- or multimode optical fibres
 - PD detection and other diagnostic capabilities

HIGH- & EXTRA-HIGH-VOLTAGE CABLE ACCESSORIES



As part of a fully integrated approach and commitment to providing complete system performance, General Cable offers a wide range of Silec HV/EHV cable accessories. Vital components of an overall cable system, these accessories are designed, manufactured and precision-controlled to ensure best-in-class performance and long-term service reliability.

Thousands of accessories in service

Voltage level (kV)	63-161	220-230	330-500
Terminations	22,612	7,432	951
Joints	11,729	6,794	547



A Complete Range Of High- and Extra-High-Voltage Cable Accessories

From 72.5 kV to 550 kV

General Cable’s advanced technology in compounding and molding of silicone, EPDM and resins translates into a complete range of high-performance accessories from 72.5 kV to 550 kV to connect the whole range of Silec cables up to 5,000 kcmil (2,500 mm²) per IEC 60840, IEC 62067, IEEE 48, IEEE 404, ICEA S-108-720 and AEIC CS9.



Engineering and Testing

Silec HV/EHV cable accessories are designed and tested through a range of calculation, modeling and testing techniques that enable General Cable to continuously adapt and optimize performance to meet the demands of our customers. Silec accessories have a history of extreme reliability.

High- and Extra-High-Voltage Cable Accessories	Maximum Voltage			
	72.5 kV	123 kV to 170 kV	245 kV	>362 kV
Joints: with or without grounding system with shield interruption with solutions for water tightness (Cu casing, etc.)	Wrapped or EPDM Pre-Molded	EPDM Pre-Molded	Short Joint	Pre-Molded EPDM
Outdoor Composite or Porcelain Terminations	Pre-Molded Stress Cone	Ester Oil Termination	Pre-Molded Stress Cone	Pre-Molded EPDM
Synthetic Terminations	Pre-Molded Shed Pre-Molded Stress Cone		–	–
GIS and Transformer (SF6 and/or Oil)	Silicon Pre-Molded – Epoxy Insulator			Pre-Molded EPDM – Epoxy Insulator
Transition Joints	Back-to-Back Joint with 2 GIS Terminations Back-to-Back Joint with One Insulator			Back-to-Back Joint with 2 GIS Terminations Side-by-Side Joint with 2 GIS Terminations
Link Boxes	Available according to the designed grounding system			
Additional Installation Materials	Designed, recommended and supplied by Silec Engineering Department Clamps, Support for Joints, Racking System, etc.			



HIGH- & EXTRA-HIGH-VOLTAGE TURNKEY SERVICES



With more than 17,000 km of cables, 30,000 terminations and 19,000 joints installed and commissioned since 1962, General Cable's Silec underground cabling solutions are your best partner for the life of the entire cable system. From system engineering and installation to final testing and post-project services, General Cable specializes in providing turnkey service management for new cable projects or the upgrading of existing cable circuits.

With decades of experience, General Cable's HV/EHV specialists design, install and manage cable systems according to customer specifications, budgets and timelines. We then provide the comprehensive assessment, monitoring, training and service programs needed to **maximize the lifetime of the system** while **reducing maintenance** and **optimizing operating costs**.

Silec North American Turnkey Services

Engineering: System and Installation Engineering

- Cable system design
- Civil design
- Complete construction specification

Management: Project Management Safety Management Environmental Management

Installation: Cable Pulling Accessory Installation and Termination Services

- Experienced and skilled technicians based in North America
- On-site coordination

Testing: On-Site Testing and Commissioning

- Visual inspection of cable system
- Testing of sheath bonding system
- High-voltage resonant tests and partial discharge (PD) measurement
- Assessment of in-service systems
- Investigation of cable system faults and failures

Emergency: After-Sales Service

- Experienced and skilled technicians
- Expedited maintenance and replacement of any circuit part up to 500 kV
- Emergency failure repair

Technical Assessments

- Comprehensive site investigations and technical assessments
- Advanced North American laboratories for testing materials and components

Stand-By Links

- For voltages up to 275 kV
- Used in substations to bypass OHL
- Maintain power transmission in the case of unusual failures
- Substation repairs and spare product support

Other: Training

- Customized training programs for maintenance crews



ONE COMPANY – YOUR SOURCE FOR GLOBAL HIGH-PERFORMANCE QUALITY CABLE, ACCESSORIES AND SERVICES



A Worldwide Partnership

As a 100% subsidiary of General Cable, Silec Cable's experience and innovation are backed by one of the most geographically diversified wire and cable companies in the world. General Cable's legacy of leadership, innovation and service spans more than 100 years, and the company is solely dedicated to the development and manufacturing of the most reliable and technologically advanced cable solutions, as well as first-rate distribution and customer service. General Cable serves customers through a global network of 47 manufacturing facilities in 25 countries and sales representatives and distribution centers worldwide.

Safety — Our First Priority

General Cable has one worldwide safety vision and goal – **ZERO AND BEYOND**. We measure safety performance globally, share best practices and implement sound health and safety management systems. Many of our facilities worldwide are OHSAS 18001 (safety management system) certified. All North American facilities have implemented an equivalent health and safety management system.

General Cable was a pioneer in obtaining the OHSAS 18001 Certificate for Occupational Health and Safety Management Systems in Europe and North Africa.



INTERNATIONAL
ISO 9001:2008
 CERTIFICATION

Environmental — Foundation of Our Actions

As a global leader in the wire and cable industry, General Cable recognizes our role and responsibility in promoting sustainability. Our strongest business value is continuous improvement in all areas of our company. Across our many businesses, the quest to introduce new and better products through continuous improvement in environmental designs reflects our commitment to achieving industry-leading standards and responding proactively to global environmental issues.

General Cable was the first cable manufacturer to obtain certification for its environmental management system, in accordance with the ISO 14001 and EMAS Standards.

Research and Development — Our Competitive Advantage

General Cable uses the latest technology and systems to ensure superior engineering and manufacturing, as well as industry-leading logistics. Our global resources deliver maximum value to customers through a powerful combination of product and service innovations. General Cable backs all operations with an unwavering dedication to responsive customer service and knowledgeable technical support.

Quality Assurance Guaranteed — Our Path to Excellence

Through ongoing quality assurance initiatives, General Cable ensures the quality of product design, manufacture, installation and expected service life, as well as respect for the environment through sustainable products, processes and policies. Continuous research and development, combined with process control, quality audits and stringent testing, provide an ever-growing range of materials and designs that meet the global approvals and standards of the electric utility industry.

Overhead Conductors

TransPowr® Bare Overhead Conductors for Transmission and Distribution

General Cable manufactures an extensive line of bare aluminum overhead products for both distribution and transmission applications. General Cable's TransPowr® bare overhead products are manufactured and tested in accordance with the latest applicable CSA and ASTM specifications.

General Cable's bare overhead conductors are available as A1 aluminum stranded conductors (ASC), A2 aluminum alloy stranded conductors (AASC), aluminum conductor steel-reinforced (ACSR or A1S1A), and aluminum conductor steel-supported (ACSS). A1 or ASC consists of 1350-H19 aluminum, is lightweight and corrosion-resistant and is commonly used in overhead line installations where higher strength or temperature ratings are not required. A2 or AASC consists of high-strength 6101 T81 aluminum alloy and is commonly used for overhead line installations adjacent to ocean coastlines where there can be a problem of corrosion in the steel of an ACSR construction. ACSR or A1S1A combines the light weight and good conductivity of 1350-H19 aluminum with the high tensile strength and ruggedness of steel. ACSR provides higher tension, less sag and longer span lengths than A1 (ASC) and A2 (AASC) overhead conductors. Standard ACSR designs are manufactured with regular-strength Class A galvanized steel (S1A).

To meet the changing needs and expectations of our customers, our highly qualified team of engineers and scientists used their conductor and material know-how to develop E3X®. E3X is an innovative coating material that provides high emissivity and low solar absorptivity characteristics, thereby allowing conductors to operate at lower temperatures, maximizing available line thermal capacity (normal & emergency) while minimizing capital investment and electrical losses. By simply applying the coating to the surface of any overhead conductor design, E3X Technology offers engineered "fixed" *emissivity* and *absorptivity* values in place of what had been previously a significant "variable" in line rating, thus reducing a source of risk when calculating the optimal thermal capacity of a transmission line. Groundbreaking E3X Technology allows utilities to optimize the power grid by adding more power and controlling losses with significant first-cost and long-term operational savings. For more details about this technology, see page 54.

With over 40 years of experience, General Cable is able to offer the option of utilizing TransPowr® ACSS conductors as an alternative for new line ACSR construction projects or for reconductoring opportunities. With its unique ability to operate at higher temperatures and withstand harsh environmental factors, TransPowr® ACSS allows utilities to modernize and optimize the nation's electrical grid with minimal capital investment. TransPowr® ACSS offers better performance over ACSR when it operates at high temperatures without detriment to its mechanical properties and with significantly less sag, allowing for much higher ampacity ratings. Standard ACSS designs are manufactured with 1350-O aluminum and regular-strength Class A zinc-5% aluminum mischmetal alloy coated steel (MA2). With several steel core options such as mischmetal, aluminum-clad steel and galvanized steel, TransPowr® ACSS is easily customized to meet specific applications and performance levels. TransPowr® ACSS is an affordable, long-lasting conductor with improved performance and reliability, made from aluminum and steel components that have been used in transmission lines for more than a hundred years. With thousands of miles installed throughout North America, ACSS is a proven, trustworthy overhead conductor technology and remains the most accepted solution for high-temperature performance.

General Cable has partnered with CTC Global to manufacture, promote and sell the high performance ACCC® conductor for applications in the U.S., Canada and Puerto Rico. This high-capacity and low-loss conductor is built with a composite carbon fiber core in lieu of the steel core used in conventional overhead conductor. ACCC/TW can provide unique solutions for the design of transmission and distribution lines by providing an additional conductor option to evaluate.

See the following page for a complete list and description of the numerous options that are available for TransPowr® overhead products. For ACSR (A1S1A) and ACSS concentric round or trapezoidal conductors, a myriad of aluminum and steel stranding combinations are available. In addition, a variety of steel strengths and types of coatings or claddings is available. Trapezoidal AAC, ACSR and ACSS conductor designs are listed in separate catalog sections. Compact aluminum and ACSR stranded conductor information is also listed.

While General Cable manufactures a complete range of bare overhead products, only the most popular designs are described in the following section. Details of other conductor sizes and designs are available upon request.

General Cable provides technical assistance and advice on any challenges associated with conductor design, installation or application. Engineering services are available for specification review, specification development and conductor application inquiries. For more information, contact your General Cable sales representative or e-mail info@generalcable.com.

Current Standards and Specifications:

C49.2 Compact Aluminum Conductors Steel Reinforced (ACSR)

C49.3 Aluminum Alloy 1350 Round Wire, For Electrical Purposes

C49.5 Compact Round Concentric Lay Aluminum Stranded Conductors

C49.8 Bare Overhead Aluminum Conductors for Distribution Applications

- Replaced CEA WCWG 03

G12 Zinc Coated Steel Wire Strand

CAN/CSA C60888: Zinc-Coated Steel Wires for Stranded Conductors

- Replaced C49.6

CAN/CSA C60889: Hard-Drawn Aluminum Wire for Overhead Conductors

- Replaced C49.7

CAN/CSA C60104: Aluminum-Magnesium-Silicon Alloy Wire for Overhead Line Conductors

CAN/CSA C61089: Round Wire Concentric Lay Overhead Electric Stranded Conductors

- Replaced C49.1
- Replaced C49.4

CAN/CSA C61232: Aluminum-Clad Steel Wires for Electrical Purposes

C68.9 Covered Overhead Distribution Line Wire

- Replaced CEA WCWG 06



TransPowr® Bare Overhead Options:

- **E3X® Technology** – This heat-dissipating coating, when factory-applied post-stranding to the surface of any General Cable overhead conductor, increases the conductor's emissivity (improving heat dissipation) and reduces absorptivity (minimizing heat absorption) to provide an increased ampacity rating and a reduced operating temperature for a given conductor size, or a reduced conductor size for a given ampacity rating. Contact your General Cable sales representative to learn how E3X Technology can optimize the power grid by adding more power and controlling losses with significant first-cost and long-term operational savings.
- **Non-Specular (NS)** – New overhead aluminum electrical conductors typically have a shiny surface. This reflective or “specular” surface can make a transmission line more noticeable against the background landscape. A factory treatment of the outer surface of the aluminum wires can render the surface finish into a dull, non-specular (NS) matte gray finish. This non-reflective or “de-glared” surface finish allows the conductor to become less visible when observed from a distance and enables the transmission line to blend in with the skyline or landscape background. The non-specular surface finish option is available for all types of bare overhead conductors that have aluminum outer strand wires.
- **High-Conductivity Aluminum (HC)** – The normal 1350 hard-drawn aluminum material used for an ACSR-type conductor has a minimum lot average conductivity value of 61.2% IACS (International Association Copper Standard). By carefully selecting the feed stock of the raw materials and manufacturing process used to refine the aluminum and convert it into rolled rod, a purer grade of 1350 aluminum can be manufactured. When this is done, the aluminum minimum lot average conductivity value is increased to 62.2%. The use of the higher conductivity metal means the overall electrical resistance of the conductor is lowered. Lowering the electrical resistance means there are lower line losses incurred in the transmission line.
- **Mischmetal Alloy-Coated Steel** – For ACSR conductors, traditionally zinc has been used to coat (galvanize) the steel to provide corrosion protection. In lieu of galvanized steel, a 95% zinc/5% aluminum mischmetal alloy is available as an optional steel wire coating. This alloy demonstrates improved corrosion resistance and high temperature resilience as compared to regular zinc. Due to its high temperature capabilities, mischmetal alloy-coated steel is standard for ACSS conductors.
- **Ultra-High-Strength Steel** – Higher strength steel grades are available for ACSR and ACSS conductors. These steel grades boost the conductor-rated strength and can, therefore, provide lower sag without increasing conductor weight or diameter. General Cable identifies the new ultra-high-strength steel as GA5 (for zinc-coated steel) and MA5 (for zinc-5% aluminum mischmetal alloy-coated steel) in accordance with the ASTM standards (ASTM B957 for GA5 steel and ASTM B958 for MA5 steel).

Index	Page
Bare Overhead Conductor	
TransPowr with E3X® Technology	53-56
A1 (ASC)	57-62
Compact (Smooth Body) ASC	63-66
AAC/TW	67-72
A2 (AASC)	73-76
ACSR	77-86
Compact (Smooth Body) ACSR	87-90
ACSR/TW	91-98
ACSS	99-108
ACSS/TW	109-116
ACSR/SD	117-122
ACCC®/TW Trapezoidal Aluminum Conductor Composite Core	123-126
Covered Overhead Conductor – Line Wire	
Covered ACSR Compact Conductor Line Wire	128
Covered ACSR Concentric Conductor Line Wire	128
Covered ASC Concentric Conductor Line Wire	129
Covered ASC Compact Conductor Line Wire	129
Covered MHD Copper Conductor Line Wire	130
Covered Overhead Conductor – Tree Wire	
AAC Single Layer 5 kV and Dual Layer 15 kV	131
AAAC Single Layer 5 kV and Dual Layer 15 kV	132
ACSR Single Layer 5 kV and Dual Layer 15 kV	133
Aluminum Tie Wire	
Aluminum Tie Wire	134



Overhead Conductors

TransPowr® Bare Overhead Options (cont'd.):

- Aluminum-Clad Steel (20SA [AW])** – Aluminum-clad steel features a thick aluminum cladding over the steel rather than a zinc or mischmetal coating. Aluminum-clad steel is chosen for coastal locations or applications where there are severe corrosion concerns for the steel core and a zinc or mischmetal coated steel will not last. Aluminum-clad steel also offers the advantage of having a higher conductivity than conventional galvanized steel wires. The higher conductivity will reduce the line loss parameters of the transmission line, saving energy and reducing the day-to-day operating cost. In an ACS conductor, aluminum-clad steel can allow the conductor to be operated up to 250°C. In Canada, the 20SA (ASTM “AW”) identifier is used for aluminum-clad steel. Elsewhere in the world, other designations are used. Aluminum-clad steel core wires are manufactured in accordance with CAN/CSA C61232.
- Compact (Smooth Body) Conductors** – General Cable can supply compact AAC (to CSA 49.5) and compact ACSR (to CSA 49.2) “smooth body” type conductor products for distribution conductor sizes. Compact conductors reduce the overall diameter of the conductor, thus lowering the resultant wind and ice loads on the conductor. In heavy ice load locations, the compact conductor option can improve conductor sag. Contact your General Cable sales representative for additional information.
- Trapezoidal (TW) Conductors** – For overhead transmission conductors, General Cable can supply trapezoidal compact conductors. The aluminum wires in a standard round wire stranded conductor leave approximately 25% of an air gap between the aluminum strands. Compacting the aluminum strands into the trapezoidal (TW) shape allows for a significant reduction of this empty air space and greater aluminum content. This allows for a conductor that either has a) the same cross-sectional area of aluminum and a reduced overall conductor diameter or b) the same overall conductor diameter, but more aluminum cross-sectional area. Reducing the overall diameter of the conductor provides the advantage of lowering the resultant ice and wind loading on the conductor. Maintaining the same diameter but increasing the aluminum metal content lowers the power loss in the conductor, as well as increasing conductor ampacity.
- Aluminum Alloy Steel-Reinforced Conductors (A2/SxA)** – General Cable can provide ACSR conductors where the A1 (1350 H19) aluminum wires are replaced with the higher strength A2 (6101 T81) or A4 (6101 T83) aluminum alloy material. These types of high strength conductors are often used in river crossings or for long span applications where the traditional ACSR conductor will not work. Contact General Cable to find out more details about these customized conductor constructions and see how they might be of benefit to you and your line design application.
- ULS** – Extra High Strength composite carbon fiber core enabling greater strength and lower sag due to ice for use in locations where heavy or extreme ice loading conditions exist (ULS ACCC).

TransPowr® bare overhead conductors can be designed to meet special applications and requirements. For designs not found in these catalog pages, contact your General Cable sales representative.



THE UTILITY INDUSTRY'S FIRST HEAT-DISSIPATING OVERHEAD CONDUCTOR

TransPowr[®]
with **E3X** TECHNOLOGY

More Power.
Less Cost.

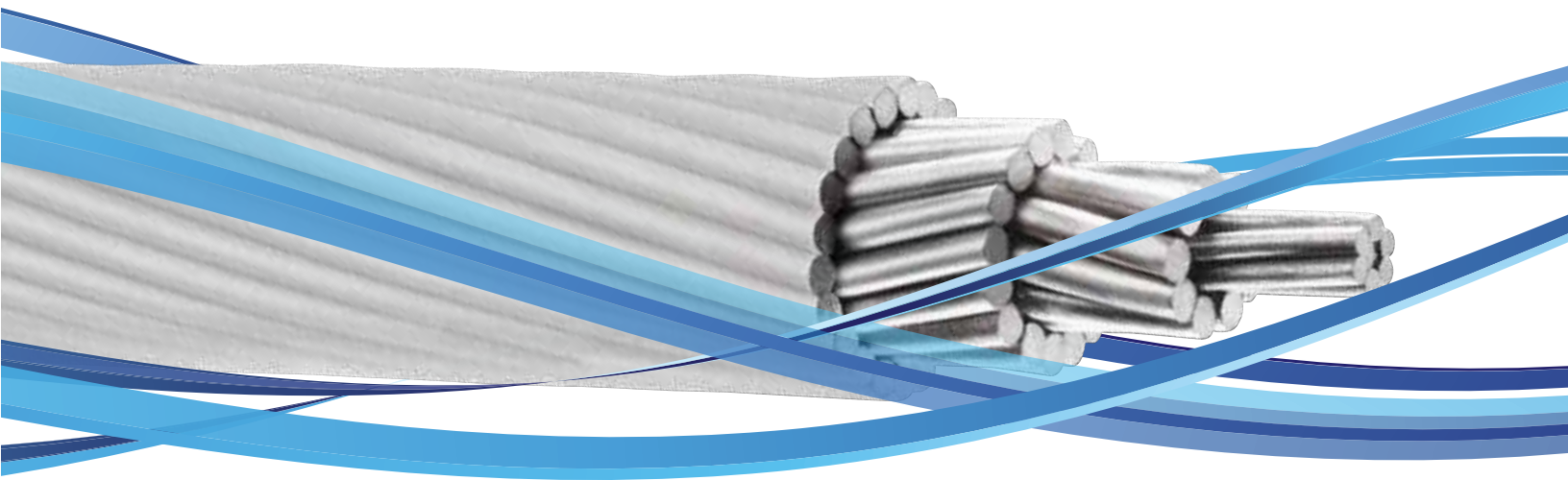

Reduce Your Costs and Increase Your Power

Groundbreaking E3X® Technology allows utilities to optimize the power grid by adding more capacity and controlling losses with significant first-cost and long-term operational savings.

TransPowr® with E3X Technology features a thin, durable coating that is applied to the surface of any TransPowr overhead conductor. This heat-dissipating coating increases *emissivity* and reduces absorptivity, improving *energy effectiveness and efficiency* by allowing for a higher ampacity rating, reduced operating temperature and lower losses for a given conductor size, or reduced conductor size for a given ampacity rating—transforming power grid sustainability, reliability, resilience and cost of ownership.



Less than 2 Years on Average Payback Period*

Savings from lower first project cost or line loss will result in an accelerated return on conductor investment.



Up to 20% Reduced Project Costs*

A reduced conductor sag or size enables optimized structures, hardware and labor for new lines.



Up to 25% Increased Ampacity*

Lowers reconductoring cost by increasing conductor ampacity without upgrading existing infrastructure.



Up to 25% Lower Line Loss*

Reduces conductor line losses via lower operating temperature, resulting in significant lifetime savings.

AND

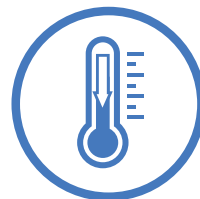

Up to 30% Reduced Operating Temperature*

Lower operating temperature reduces power losses and increases power-carrying capacity, for efficiency and lower total system costs.

CASE STUDY

Cross Texas Transmission CREZ Project

BACKGROUND

Cross Texas Transmission (CTT), an affiliate of LS Power, was designated by the Public Utility Commission of Texas (PUCT) to construct, operate and maintain 238 miles of transmission lines as part of PUCT’s commitment to deliver renewable energy from Competitive Renewable-Energy Zones (CREZ). These zones, located in West Texas and the Texas Panhandle, are resource-rich, high-wind areas. The CREZ projects were ultimately constructed by 8 different utilities to transmit 18,456 MW of wind power over more than 2,300 miles of transmission lines from the zones to approximately five million homes and businesses. The CTT portion of the CREZ initiative consisted of approximately 1,300 structures that included lattice and monopole steel towers ranging from 80 to 200 feet tall. The 238 miles of Falcon/ACSS/MA2 transmission lines consisted of double-circuit, double-bundle 345 kV AC lines running in three segments, totaling 2,820 conductor miles.

FIRST-COST SAVINGS WITH E3X

\$11MM to \$13MM Savings¹

PRIMARY OBJECTIVE

With assistance from Burns & McDonnell and LS Power, estimate the potential first-cost savings for the CTT CREZ project if an equivalent ampacity Pheasant/ACSS/MA2 with E3X[®] Technology had been implemented. First project cost savings are calculated based on reduced mechanical loading due to the change in conductor size in both round wire and trapezoidal constructions.



Original Conductor Design & E3X Technology Options	Ampacity @ 200°C ²	Conductor Weight (lb/kft)	Material Cost Savings (\$/mile)
1590 kcmil 54/19 Falcon/ACSS/MA2	2372	2039	Original Base Design
1272 kcmil 54/19 Pheasant/ACSS/MA2/E3X	2360	1631	\$45,743/mile
1272 kcmil 59/19 Pheasant/ACSS/TW/MA2/E3X	2357	1636	\$55,382/mile

¹ Neglected potential cost savings associated with smaller conductor diameter hardware, structure erection costs, foundation rock excavation and casings.

² Ampacities calculated per IEEE 738 and the following conditions: 40°C ambient temperature, 2 ft/s wind velocity (90° to conductor), 35° northern latitude, 3500 ft elevation, 90° azimuth of line (East-West), clear atmosphere, and a date and time of 12:00 PM on June 21 (resulting in 106.3 W/ft² of solar and sky radiated heat). Standard conductor calculated with an emissivity of 0.5 and an absorptivity of 0.5; E3X conductor calculated with values of 0.9 and 0.2 respectively.

ENERGY SAVINGS WITH E3X

Net Present Value of Savings — \$150MM¹

SECONDARY OBJECTIVE

Estimate the potential energy savings associated with conductor losses for the CTT CREZ project if a Falcon/ACSS/MA2 with E3X Technology had been implemented. Energy savings are based on a conservative 20% reduction in operating temperature due to application of the high emissivity, low absorptivity E3X Technology.



Parameter	1590 kcmil Falcon/ACSS/MA2 100°C - 1452 Amps ²	1590 kcmil Falcon/ACSS/MA2/E3X 80°C - 1452 Amps ²	NPV of Savings Per Conductor	NPV of Savings for Transmission Line
Power Losses (kW/mile)	165	157	8	98
Annual Energy Losses (kWh/mile)	470,982	447,620	23,362	280,344
Annual Energy Cost (\$/mile)	\$36,307	\$34,506	\$1,801	\$21,612
Annual Demand Cost (\$/mile)	\$33,748	\$32,074	\$1,674	\$20,088
NPV of Energy Savings (\$/mile)	-	-	\$53,419	\$641,027

¹ Economic Analysis calculated per Aluminum Association Publication No. 54 with the following parameters: transmission application, 1452 ampacity, \$1000/kW cost of installed generating capacity, 17% fixed charge rate on generating capacity, 50% load factor, \$0.060/kWh present cost of energy, 30-year service life of conductor, and 5% interest rate. Additional significant savings potentially available from carbon credits.

² Ampacities calculated per IEEE 738 and the following conditions: 40°C ambient temperature, 2 ft/s wind velocity (90° to conductor), 35° northern latitude, 3500 ft elevation, 90° azimuth of line (East-West), clear atmosphere, and a date and time of 12:00 PM on June 21 (resulting in 106.3 W/ft² of solar and sky radiated heat). Standard conductor calculated with an emissivity of 0.5 and an absorptivity of 0.5. E3X conductor calculated with values of 0.9 and 0.2 respectively.

INDEPENDENT VERIFICATION AND VALIDATION OF E3X[®] TECHNOLOGY

Oak Ridge National Laboratory (ORNL) Powerline Conductor Accelerated Testing (PCAT)

ORNL PCAT FACILITY

PCAT in Oak Ridge, Tennessee was developed by ORNL and the U.S. Department of Energy in 2003 as a test facility to evaluate the performance and reliability of overhead conductor designs in a real-world environment either before or in conjunction with field trials. PCAT accommodates 2,400 ft of overhead test conductor in a loop arrangement across five 161 kV-rated steel transmission poles, with two poles at each of the two dead-ends and one in the center with a cross-arm. The facility uniquely provides a high-power, heavily instrumented and controlled platform for conducting accelerated performance testing and collecting all the necessary information for overhead conductor characterization.

ORNL PCAT OBJECTIVE

A test plan was designed to evaluate the sag/tension, current-carrying and temperature characteristics of Drake/ACSS/MA2 with E3X Technology against standard Drake/ACSS/MA2 utilizing constant current tests and current thermal/mechanical cycling tests. The charts on Temperature and Sag versus Ampacity are based on test data generated at the ORNL PCAT facility.

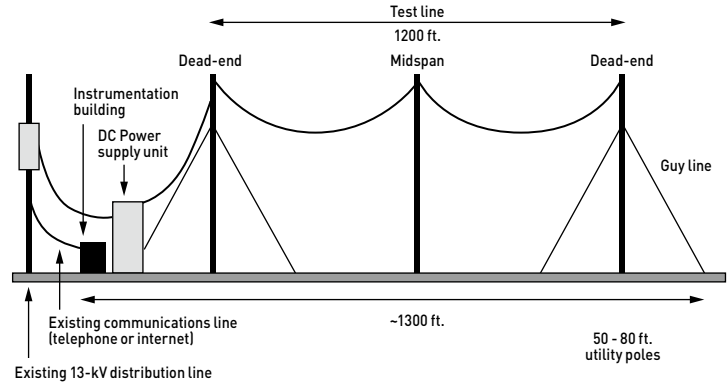

OAK RIDGE NATIONAL LABORATORY: Temperature vs. Ampacity

- Drake/ACSS/MA2
- ◆ Drake/ACSS/MA2/E3X

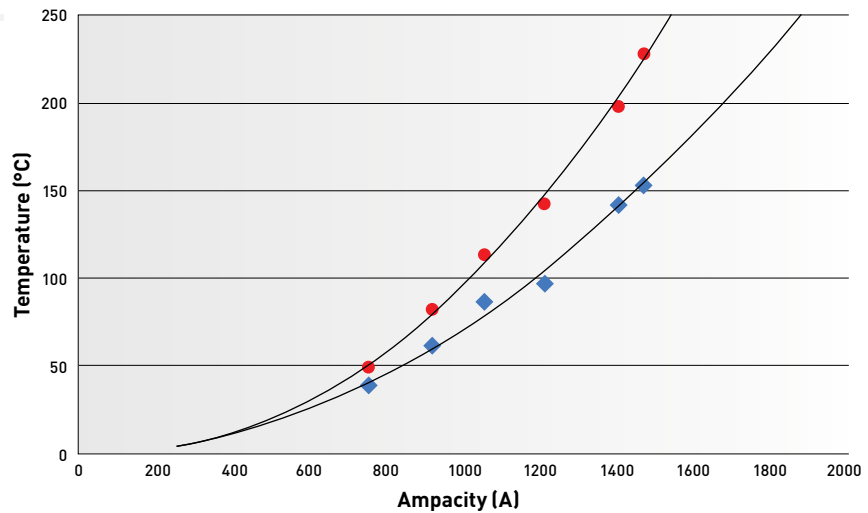

OAK RIDGE NATIONAL LABORATORY: Sag vs. Ampacity

- Drake/ACSS/MA2
- ◆ Drake/ACSS/MA2/E3X

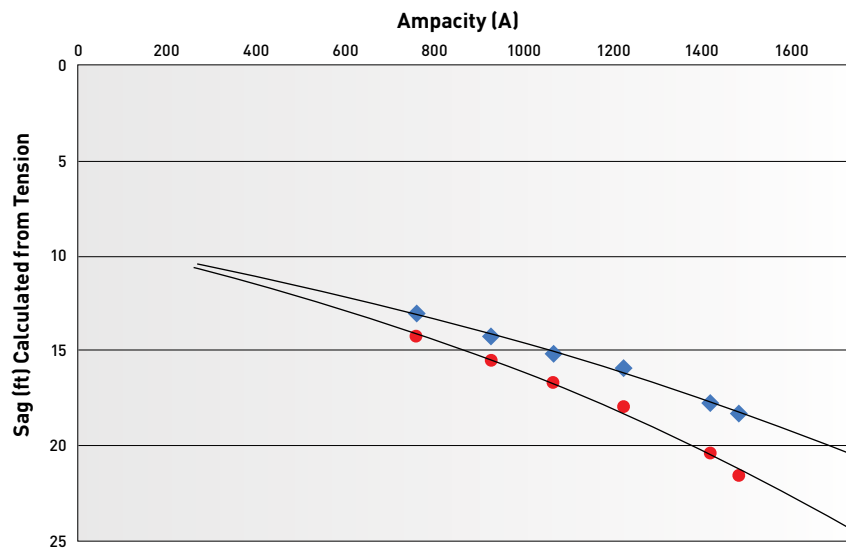

TransPowr® A1 (ASC) Bare Overhead Conductor

All-Aluminum 1350 Conductor Concentric-Lay-Stranded

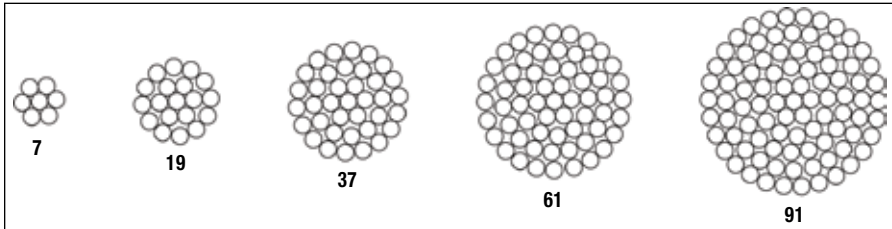

Product Construction:

Complete Conductor:

Bare all-aluminum 1350 (A1 or ASC) are concentric-lay-stranded conductors consisting of one or more layers of wire wrapped helically around a straight round central wire. Each successive layer has six wires more than the layer immediately beneath. Greater flexibility is provided by increasing the number of strands for a specific cross-sectional area. A1 or ASC conductors are manufactured in accordance with the requirements of the latest applicable issue of CAN/CSA C61089.

A1 or ASC (Aluminum Stranded Conductor) conductors are CSA reference terms. The Canadian constructions are similar in design (strand component size and configuration) to the ASTM B231 specifications. Differences lie in the methods used to calculate the rated strength and dc resistance values.

The commonly used strandings are 7, 19, 37, 61 and 91. The sizes and strandings listed on the following pages are common examples used in overhead lines. Metric (mm²) sizes are also available.

Complete Conductor (cont'd.):

Class AA strandings are used for bare overhead lines. The direction of lay of the outer layer is right-hand and is normally reversed in successive layers. The temper is full hard drawn (H19).

Class A strandings are used primarily for overhead conductors which are to be covered with weather-resistant materials. Greater flexibility is provided than Class AA. The outer layer is right-hand, and the temper is generally H19. Successive layers are normally reverse lay.

Features and Benefits:

Optimum economy is provided since the lighter weight means lower unit length costs, easier handling in installation and less complex fittings. All-aluminum conductors have an inherent high corrosion resistance due to their homogeneous construction.

Applications:

Stranded bare A1 or ASC 1350 all-aluminum conductors are used for overhead line installations where design parameters do not require the higher strength or temperature ratings provided by ACSR, ACSS or other type of bare conductor.

Options:

- Compact aluminum strands (CSA C49.5)
- Trapezoidal-shaped aluminum strands (/TW)
- High-Conductivity aluminum (/HC) (62.2% IACS)
- Non-Specular surface finish (/NS)
- E3X® surface coating (/E3X)

For more information, contact your General Cable sales representative or e-mail infoca@generalcable.com.



TransPowr® A1 (ASC) Bare Overhead Conductor

All-Aluminum 1350 Conductor Concentric-Lay-Stranded

A1 (ASC), ALUMINUM CONDUCTOR, CONCENTRIC-LAY-STRANDED (MECHANICAL PROPERTIES)

CODE WORD	CSA DESIGNATION	CONDUCTOR SIZE		STRANDING NO. X DIA. (mm)	CLASS	O.D. (mm)	NOMINAL MASS KG/KM	RATED STRENGTH kN
		AWG or kcmil	mm ²					
Peachbell	13-A1-7	#6	13.3	7x1.56	A	4.68	36.66	2.61
Rose	21-A1-7	#4	21.2	7x1.96	A	5.88	57.87	4.12
Iris	34-A1-7	#2	33.6	7x2.47	A, AA	7.41	91.91	6.21
Pansy	42-A1-7	#1	42.4	7x2.78	A, AA	8.34	116.4	7.44
Poppy	54-A1-7	1/0	53.5	7x3.12	A, AA	9.36	146.6	9.10
Aster	67-A1-7	2/0	67.4	7x3.50	A, AA	10.5	184.5	11.4
Phlox	85-A1-7	3/0	85.0	7x3.93	A, AA	11.8	232.7	14.0
Oxlip	107-A1-7	4/0	107.2	7x4.42	A, AA	13.3	294.3	17.7
Daisy	135-A1-7	266.8	135.2	7x4.96	AA	14.9	370.6	22.3
Laurel	135-A1-19	266.8	135.2	19x3.01	A	15.1	372.0	23.0
Peony	152-A1-19	300	152.0	19x3.19	A	16.0	417.9	25.8
Tulip	170-A1-19	336.4	170.5	19x3.38	A	16.9	469.1	29.0
Daffodil	177-A1-19	350	177.4	19x3.45	A	17.3	488.7	30.2
Canna	201-A1-19	397.5	201.4	19x3.67	A,AA	18.4	553.1	34.2
Cosmos	242-A1-19	477	241.7	19x4.02	AA	20.1	663.6	39.8
Syringa	242-A1-37	477	241.7	37x2.88	A	20.2	665.5	42.2
Zinnia	500-A1-19	500	253.4	19x4.12	AA	20.6	697.0	41.8
Hyacinth	253-A1-37	500	253.4	37x2.95	A	20.7	698.2	44.3
Dahlia	282-A1-19	556.5	282.0	19x4.35	AA	21.8	777.0	46.6
Mistletoe	282-A1-37	556.5	282.0	37x3.12	A	21.8	781.0	48.1
Meadowsweet	304-A1-37	600	304.0	37x3.23	A, AA	22.6	837.0	51.5
Orchid	322-A1-37	636	322.3	37x3.33	A, AA	23.3	889.7	54.8
Violet	363-A1-37	715.5	362.6	37x3.53	AA	24.7	999.7	61.6
Nasturtium	363-A1-61	715.5	362.6	61x2.75	A	24.8	1005	65.2
Petunia	380-A1-37	750	380.0	37x3.62	AA	25.3	1051	64.7
Arbutus	403-A1-37	795	402.8	37x3.72	AA	26.0	1110	68.4
Lilac	403-A1-61	795	402.8	61x2.90	A	26.1	1117	70.5
Fuchsia	405-A1-37	800	405.4	37x3.73	AA	26.1	1116	68.7
Heliotrope	405-A1-61	800	405.4	61x2.91	A	26.2	1125	71.0
Anemone	443-A1-37	874.5	443.1	37x3.90	AA	27.3	1220	72.9
Crocus	443-A1-61	874.5	443.1	61x3.04	A	27.4	1228	75.3
Magnolia	483-A1-37	954	483.4	37x4.08	AA	28.6	1336	79.8
Goldenrod	483-A1-61	954	483.4	61x3.18	A	28.6	1343	82.4
Camellia	507-A1-61	1000	506.7	61x3.25	A	29.3	1403	86.0
Bluebell	524-A1-37	1033.5	523.7	37x4.25	AA	29.8	1449	86.6
Larkspur	524-A1-61	1033.5	523.7	61x3.31	A	29.8	1455	89.2
Marigold	564-A1-61	1113	564.0	61x3.43	A, AA	30.9	1563	95.8
Hawthorn	604-A1-61	1192.5	604.3	61x3.55	A, AA	32.0	1674	103
Narcissus	645-A1-61	1272	644.5	61x3.67	A, AA	33.0	1789	110
Columbine	685-A1-61	1351.5	684.8	61x3.78	A, AA	34.0	1898	113
Carnation	725-A1-61	1431	725.1	61x3.89	A, AA	35.0	2010	120

Dimensions and weights not designated as minimum or maximum are nominal values and subject to manufacturing tolerances. In this context, weight means mass.

TransPwr® A1 (ASC) Bare Overhead Conductor

All-Aluminum 1350 Conductor Concentric-Lay-Stranded

A1 (ASC), ALUMINUM CONDUCTOR, CONCENTRIC-LAY-STRANDED (ELECTRICAL PROPERTIES)

CODE WORD	CONDUCTOR SIZE		RESISTANCE (1)OHMS/KM			AMPACITY @75°C (2)		GEOMETRIC MEAN RADIUS CM	INDUCTIVE REACTANCE OHM/KM (3)	CAPACITIVE REACTANCE MEGAOHM-KM (3)
	AWG or kcmil	mm ²	DC @20°C	AC @25°C	AC @75°C	STANDARD	E3X®			
Peachbell	#6	13.3	2.153	2.196	2.631	95	102	0.171	0.3911	0.2326
Rose	#4	21.2	1.354	1.381	1.655	127	137	0.213	0.3740	0.2215
Iris	#2	33.6	0.8514	0.8687	1.041	170	185	0.268	0.3570	0.2105
Pansy	#1	42.4	0.6751	0.6889	0.8252	196	214	0.302	0.3481	0.2050
Poppy	1/0	53.5	0.5351	0.5460	0.6541	227	249	0.338	0.3393	0.1994
Aster	2/0	67.4	0.4246	0.4333	0.5190	262	289	0.381	0.3304	0.1939
Phlox	3/0	85.0	0.3367	0.3437	0.4117	303	336	0.427	0.3219	0.1884
Oxlip	4/0	107.2	0.2671	0.2727	0.3266	351	391	0.482	0.3127	0.1828
Daisy	266.8	135.2	0.2118	0.2164	0.2591	406	455	0.539	0.3041	0.1773
Laurel	266.8	135.2	0.2127	0.2174	0.2603	406	455	0.570	0.2999	0.1767
Peony	300	152.0	0.1892	0.1935	0.2316	437	491	0.604	0.2956	0.1739
Tulip	336.5	170.5	0.1687	0.1726	0.2066	469	530	0.640	0.2914	0.1712
Daffodil	350	177.4	0.1621	0.1659	0.1986	481	543	0.652	0.2897	0.1703
Canna	397.5	201.4	0.1428	0.1463	0.1750	521	590	0.695	0.2851	0.1672
Cosmos	477	241.7	0.1190	0.1222	0.1461	584	665	0.762	0.2782	0.1628
Syringa	477	241.7	0.1194	0.1226	0.1466	583	664	0.774	0.2769	0.1627
Zinnia	500	253.4	0.1135	0.1166	0.1394	601	686	0.780	0.2763	0.1617
Hyacinth	500	253.4	0.1139	0.1171	0.1399	600	685	0.792	0.2753	0.1616
Dahlia	556.5	282.0	0.1020	0.1049	0.1254	642	735	0.823	0.2723	0.1592
Mistletoe	556.5	282.0	0.1023	0.1054	0.1259	642	734	0.838	0.2710	0.1590
Meadowsweet	600	304.0	0.09490	0.09790	0.1169	672	771	0.869	0.2684	0.1572
Orchid	636	322.3	0.08951	0.09247	0.1104	697	801	0.896	0.2658	0.1558
Violet	715.5	362.6	0.07956	0.08246	0.09832	750	865	0.948	0.2618	0.1530
Nasturtium	715.5	362.6	0.07991	0.08286	0.09879	748	863	0.957	0.2608	0.1529
Petunia	750	380.0	0.07592	0.07880	0.09392	772	891	0.972	0.2599	0.1519
Arbutus	795	402.8	0.07162	0.07450	0.08873	800	925	1.000	0.2576	0.1505
Lilac	795	402.8	0.07192	0.07486	0.08915	799	924	1.01	0.2569	0.1504
Fuchsia	800	405.4	0.07117	0.07404	0.08819	803	929	1.00	0.2576	0.1504
Heliotrope	800	405.4	0.07147	0.07441	0.08860	802	927	1.01	0.2569	0.1503
Anemone	874.5	443.1	0.06511	0.06799	0.08089	848	984	1.05	0.2539	0.1482
Crocus	874.5	443.1	0.06538	0.06833	0.08128	847	982	1.06	0.2533	0.1482
Magnolia	954	483.4	0.05968	0.06259	0.07437	895	1041	1.10	0.2507	0.1461
Goldenrod	954	483.4	0.05993	0.06291	0.07474	893	1039	1.10	0.2503	0.1461
Camellia	1000	506.7	0.05718	0.06018	0.07144	919	1070	1.13	0.2484	0.1450
Bluebell	1033.5	523.7	0.05509	0.05804	0.06887	939	1095	1.14	0.2477	0.1443
Larkspur	1033.5	523.7	0.05532	0.05835	0.06922	937	1093	1.15	0.2471	0.1442
Marigold	1113	564.0	0.05137	0.05446	0.06451	980	1146	1.19	0.2444	0.1424
Hawthorn	1192.5	604.3	0.04794	0.05109	0.06044	1022	1197	1.23	0.2418	0.1407
Narcissus	1272	644.5	0.04495	0.04818	0.05690	1062	1247	1.27	0.2395	0.1392
Columbine	1351.5	684.8	0.04231	0.04561	0.05378	1101	1295	1.31	0.2372	0.1378
Carnation	1431	725.1	0.03996	0.04334	0.05102	1139	1342	1.35	0.2349	0.1364

(1) Based on a conductivity of 61.0% IACS at 20°C for aluminum.

(2) Based on a conductor temperature of 75°C at 60 Hz and the following conditions, 32°C ambient temperature, 1.98 ft/sec (0.6 m/sec) crosswind (90° to conductor), 0.5 coefficient of emissivity for a standard conductor and 0.9 for a E3X coated conductor, 0.5 coefficient of absorptivity for a standard conductor and 0.2 for a E3X coated conductor, 42° northern latitude, sea level elevation, 90° azimuth of line (East-West), clear atmosphere, and a date and time of noon on July 1 (resulting in 95.0 W/ft² of solar and sky radiated heat). Actual ampacity will differ based on local conditions. For specific ampacities, please contact your General Cable sales representative.

(3) Values for inductive reactance and capacitive reactance are expressed in terms of a 1 ft radius (30.48 cm).



TransPowr® A1 (ASC) Bare Overhead Conductor

All-Aluminum 1350 Conductor Concentric-Lay-Stranded

A1 (ASC), ALUMINUM CONDUCTOR, CONCENTRIC-LAY-STRANDED (MECHANICAL PROPERTIES)

CODE WORD	CSA DESIGNATION	CONDUCTOR SIZE		STRANDING NO. X DIA. (mm)	CLASS	O.D. (mm)	NOMINAL MASS KG/KM	RATED STRENGTH kN
		AWG or kcmil	mm ²					
Gladiolus	765-A1-61	1510.5	765.4	61x4.00	A, AA	36.0	2125	126
Coreopsis	806-A1-61	1590	805.7	61x4.10	AA	36.9	2233	133
Jessamine	887-A1-61	1750	886.7	61x4.30	AA	38.7	2456	146
Cowslip	1013-A1-91	2000	1013.4	91x3.77	A	41.5	2827	168
Sagebrush	1140-A1-91	2250	1140.0	91x3.99	A	43.9	3166	188
Pigweed	1165-A1-61	2300	1165.4	61x4.93	A	44.4	3229	192
Lupine	1267-A1-91	2500	1266.8	91x4.21	A	46.3	3525	209
Bitterroot	1393-A1-91	2750	1393.5	91x4.42	A	48.6	3886	230
Trillium	1520-A1-127	3000	1520.1	127x3.90	A	50.7	4232	250
Bluebonnet	1773-A1-127	3500	1773.5	127x4.22	A	54.9	4955	293

Dimensions and weights not designated as minimum or maximum are nominal values and subject to manufacturing tolerances. In this context, weight means mass.

TransPowr® A1 (ASC) Bare Overhead Conductor

All-Aluminum 1350 Conductor Concentric-Lay-Stranded

A1 (ASC), ALUMINUM CONDUCTOR, CONCENTRIC-LAY-STRANDED (ELECTRICAL PROPERTIES)

CODE WORD	CONDUCTOR SIZE		RESISTANCE (1)OHMS/KM			AMPACITY @75°C (2)		GEOMETRIC MEAN RADIUS CM	INDUCTIVE REACTANCE OHM/KM (3)	CAPACITIVE REACTANCE MEGAOHM-KM (3)
	AWG or kcmil	mm ²	DC @20°C	AC @25°C	AC @75°C	STANDARD	E3X®			
Gladiolus	1510.5	765.4	0.03785	0.04133	0.04856	1175	1388	1.39	0.2330	0.1351
Coreopsis	1590	805.7	0.03596	0.03952	0.04636	1211	1433	1.43	0.2310	0.1339
Jessamine	1750	886.7	0.03267	0.03641	0.04256	1280	1519	1.49	0.2274	0.1316
Cowslip	2000	1013.4	0.02869	0.03278	0.03808	1376	1642	1.60	0.2221	0.1284
Sagebrush	2250	1140.0	0.02551	0.02987	0.03450	1468	1759	1.70	0.2175	0.1256
Pigweed	2300	1165.4	0.02486	0.02922	0.03372	1489	1785	1.71	0.2172	0.1251
Lupine	2500	1266.8	0.02295	0.02759	0.03168	1553	1868	1.79	0.2136	0.1231
Bitterroot	2750	1393.5	0.02087	0.02575	0.02941	1632	1969	1.88	0.2100	0.1208
Trillium	3000	1520.1	0.01917	0.02432	0.02764	1703	2062	1.97	0.2067	0.1187
Bluebonnet	3500	1773.5	0.01644	0.02198	0.02477	1836	2236	2.12	0.2008	0.1150

(1) Based on a conductivity of 61.0% IACS at 20°C for aluminum.

(2) Based on a conductor temperature of 75°C at 60 Hz and the following conditions, 32°C ambient temperature, 1.98 ft/sec (0.6 m/sec) crosswind (90° to conductor), 0.5 coefficient of emissivity for a standard conductor and 0.9 for a E3X coated conductor, 0.5 coefficient of absorptivity for a standard conductor and 0.2 for a E3X coated conductor, 42° northern latitude, sea level elevation, 90° azimuth of line (East-West), clear atmosphere, and a date and time of noon on July 1 (resulting in 95.0 W/ft² of solar and sky radiated heat). Actual ampacity will differ based on local conditions. For specific ampacities, please contact your General Cable sales representative.

(3) Values for inductive reactance and capacitive reactance are expressed in terms of a 1 ft radius (30.48 cm).



Notes

TransPowr® Compact (Smooth Body) ASC Bare Overhead Conductor

All-Aluminum Compact Stranded Conductor

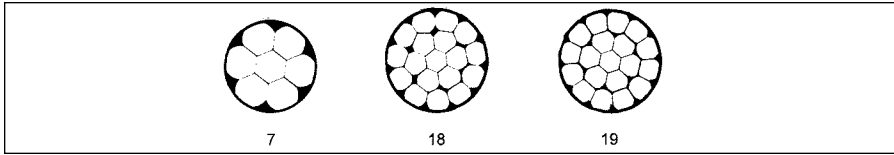

Product Construction:

Complete Conductor:

Smooth Body bare all-aluminum 1350 (A1 or ASC) are compact concentric-lay-stranded conductors consisting of one or more layers of wire wrapped helically around a straight round central wire. Smooth Body conductors are manufactured in accordance with the requirements of the latest applicable issue of CSA C49.5.

A1 or ASC (Aluminum Stranded Conductor) are CSA reference terms. The Canadian constructions are similar in design (strand component size and configuration) to the ASTM B400 specification. Differences lie in the methods used to calculate the rated strength and dc resistance values.

The commonly used strandings are 7, 18, and 19. The sizes and strandings listed on the following pages are common examples used in overhead lines. Metric (mm²) sizes are also available.

Complete Conductor (cont'd.):

Class AA strandings are used for bare overhead lines. The direction of lay of the outer layer is right-hand and is reversed in successive layers. The temper is full hard drawn (H19).

Class A strandings are used primarily for overhead conductors which are to be covered with weather-resistant materials. Greater flexibility is provided than Class AA. The direction of lay of the outer layers is right-hand and is reversed in successive layers. The temper is full hard drawn (H19).

Features and Benefits:

The conductors are smaller in diameter and offer lower ice load/wind resistance profile factors.

The conductors are lighter in weight than ACSR, which translates into lower unit length costs, easier handling in installation and less complex fittings.

All-aluminum conductors have an inherent high corrosion resistance due to their homogeneous construction.

Applications:

Stranded bare A1 or ASC 1350 all-aluminum conductors are used for overhead line installations where design parameters do not require the higher strength or temperature ratings provided by ACSR, ACSS or other type of bare conductor.

Options:

- High-Conductivity aluminum (/HC) (62.2% IACS)
- Non-Specular surface finish (/NS)
- E3X® surface coating (/E3X)

For more information, contact your General Cable sales representative or e-mail infoca@generalcable.com.



TransPowr® Compact (Smooth Body) ASC Bare Overhead Conductor

All-Aluminum Compact Stranded Conductor

A1 (ASC), ALUMINUM CONDUCTOR, COMPACT-LAY-STRANDED (MECHANICAL PROPERTIES)

CODE WORD	CSA DESIGNATION	CONDUCTOR SIZE		STRANDING NO. X DIA. (mm)	CLASS	O.D. (mm)	NOMINAL MASS KG/KM	RATED STRENGTH kN
		AWG OR kcmil	mm ²					
Toad	13-A1F-7-4.3	#6	13.3	7x1.56	A	4.28	36.58	2.61
Dragon	21-A1F-7-5.4	#4	21.2	7x1.96	A	5.41	57.74	4.12
Moloch	34-A1F-7-6.8	#2	33.6	7x2.47	AA	6.81	91.70	6.21
Monitor	42-A1F-7-7.6	#1	42.4	7x2.78	AA	7.59	116.2	7.44
Newt	42-A1F-18-7.6	#1	42.4	18x1.73	A	7.59	116.6	8.25
Tuatara	54-A1F-7-8.5	1/0	53.5	7x3.12	AA	8.53	146.3	9.10
Skink	54-A1F-18-8.6	1/0	53.5	18x1.95	A	8.55	148.2	10.5
Alligator	67-A1F-7-9.6	2/0	67.4	7x3.50	AA	9.55	184.1	11.4
Gecko	67-A1F-18-9.6	2/0	67.4	18x2.18	A	9.55	185.2	12.8
Crocodile	85-A1F-7-10.7	3/0	85.0	7x3.93	AA	10.7	232.2	14.0
Anoli	85-A1F-18-10.7	3/0	85.0	18x2.45	A	10.7	233.9	15.7
Salamander	107-A1F-7-12.1	4/0	107.0	7x4.41	AA	12.1	292.3	17.6
Clayman	107-A1F-18-12.1	4/0	107.0	18x2.75	A	12.1	294.7	19.2
Komodo	135-A1F-18-13.6	266.5	135.0	18x3.09	A	13.6	372.1	22.9

Dimensions and weights not designated as minimum or maximum are nominal values and subject to manufacturing tolerances. In this context, weight means mass.

TransPowr® Compact (Smooth Body) ASC Bare Overhead Conductor

All-Aluminum Compact Stranded Conductor

ASC, ALUMINUM CONDUCTOR, COMPACT-LAY-STRANDED (ELECTRICAL PROPERTIES)

CODE WORD	CONDUCTOR SIZE		RESISTANCE (1) OHMS/KM			AMPACITY @75°C (2)		GEOMETRIC MEAN RADIUS CM	INDUCTIVE REACTANCE OHM/KM (3)	CAPACITIVE REACTANCE MEGA OHM-KM (3)
	AWG OR kcmil	mm ²	DC @20°C	AC @25°C	AC @75°C	STANDARD	E3X®			
Toad	#6	13.3	2.148	2.191	2.625	93	99	0.162	0.3950	0.2368
Dragon	#4	21.2	1.348	1.375	1.647	125	134	0.201	0.3786	0.2255
Moloch	#2	33.6	0.8502	0.8675	1.039	166	180	0.256	0.3603	0.2146
Monitor	#1	42.4	0.6738	0.6875	0.8236	192	209	0.283	0.3527	0.2094
Newt	#1	42.4	0.6791	0.6930	0.8302	191	208	0.293	0.3504	0.2094
Tuatara	1/0	53.5	0.5340	0.5449	0.6528	222	243	0.320	0.3435	0.2038
Skink	1/0	53.5	0.5384	0.5494	0.6581	221	242	0.329	0.3416	0.2037
Alligator	2/0	67.4	0.4239	0.4326	0.5182	256	282	0.360	0.3347	0.1984
Gecko	2/0	67.4	0.4273	0.4362	0.5225	255	280	0.369	0.3330	0.1984
Crocodile	3/0	85.0	0.3361	0.3431	0.4109	297	327	0.402	0.3265	0.1928
Anoli	3/0	85.0	0.3389	0.3460	0.4144	295	326	0.411	0.3245	0.1929
Salamander	4/0	107.0	0.2670	0.2726	0.3265	343	380	0.454	0.3173	0.1872
Clayman	4/0	107.0	0.2692	0.2749	0.3293	341	379	0.463	0.3156	0.1873
Komodo	266.5	135.0	0.2133	0.2181	0.2611	395	441	0.524	0.3064	0.1814

(1) Based on a conductivity of 61.0% IACS at 20°C for aluminum.

(2) Based on a conductor temperature of 75°C at 60 Hz and the following conditions, 32°C ambient temperature, 1.98 ft/sec (0.6 m/sec) crosswind (90° to conductor), 0.5 coefficient of emissivity for a standard conductor and 0.9 for a E3X coated conductor, 0.5 coefficient of absorptivity for a standard conductor and 0.2 for a E3X coated conductor, 42° northern latitude, sea level elevation, 90° azimuth of line (East-West), clear atmosphere, and a date and time of noon on July 1 (resulting in 95.0 W/ft² of solar and sky radiated heat). Actual ampacity will differ based on local conditions. For specific ampacities, please contact your General Cable sales representative.

(3) Values for inductive reactance and capacitive reactance are expressed in terms of a 1 ft radius (30.48 cm).



Notes

TransPowr® AAC/TW Bare Overhead Conductor

Trapezoidal All-Aluminum 1350 Concentric-Lay-Stranded

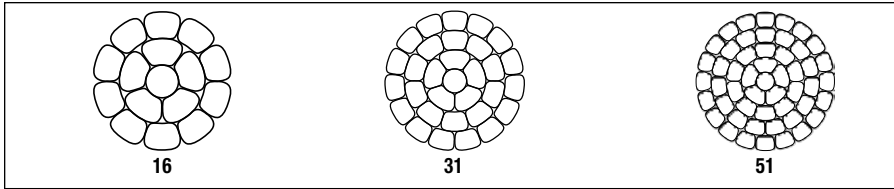

Product Construction:

Complete Conductor:

TransPowr® AAC/TW is a trapezoidal 1350 H19 aluminum (AAC) concentric-lay-stranded conductor. The aluminum strands are trapezoidal in shape. The wedge-shaped aluminum strands enable a more compact alignment of the aluminum wires.

Conductor designs that maintain the same circular mil cross-sectional area of aluminum as a conventional round conductor result in a TW conductor that is 10 to 15 percent smaller in overall diameter.

Conductor designs that maintain the same overall diameter as a conventional round conductor result in a TW conductor that has 20 to 25 percent more aluminum cross-sectional area packed in.

The AAC/TW conductors are manufactured in accordance with the requirements of the latest issue of ASTM B778.

The conductor consists of two, three, four or five layers of aluminum 1350-H19 wires. The sizes and constructions listed on this and the following pages are examples used in overhead lines.

Features and Benefits:

TransPowr® AAC /TW has a continuous operating temperature rating of 75°C. Operation of the conductor at elevated temperatures may increase the conductor sag properties and lower the rated tensile strength of the conductor.

AAC/TW conductors constructed of equivalent aluminum circular mil cross-sectional area provide a conductor that is smaller in overall diameter than the equivalent conventional round wire AAC conductor. The reduced conductor diameter is advantageous in reducing the effects of ice and wind loading on the conductor.

AAC/TW conductors constructed to equivalent overall diameter enable a greater circular mil cross-sectional area of aluminum within the conductor, allowing a significant increase in conductor current-carrying capacity.

Applications:

Trapezoidal 1350 H19 aluminum conductors (AAC/TW) are used for overhead transmission lines where design parameters do not require the higher strength or temperature ratings provided by ACSR, ACSS, or other type conductors.

Electrical Parameters:

The electrical parameters for the trapezoidal AAC equivalent circular mil area and equivalent overall diameter conductors may be found in the last table of this section.

Options:

- Compact aluminum strands
- Trapezoidal-shaped aluminum strands (/TW)
- High-Conductivity aluminum (/HC) (62.2% IACS)
- Non-Specular surface finish (/NS)
- E3X® surface coating (/E3X)

At the present time, CAN/CSA C61089 does not recognize TW conductor designs. The information provided on the following pages is from our US catalog.

For more information, contact your General Cable sales representative or e-mail infoca@generalcable.com.

TransPowr® AAC/TW Bare Overhead Conductor

Trapezoidal All-Aluminum 1350 Concentric-Lay-Stranded

AAC/TW CONDUCTORS (MECHANICAL PROPERTIES) – REDUCED DIAMETER – CONDUCTORS SIZED TO HAVE EQUIVALENT CIRCULAR MIL AREA TO REGULAR AAC

CODE WORD	SIZE AWG OR kcmil	NO. OF AL WIRES	EQUIVALENT STRAND WIRE DIA. INCHES	FILL FACTOR	CROSS-SECTION SQ. INCHES	O.D. INCHES	APPROX. WEIGHT LB/1000 FT	RATED STRENGTH LBS	STANDARD PACKAGES (1)		
									REEL DESIGNATION	WEIGHT LBS	LENGTH FT
Tulip/AAC/TW	336.4	16	0.1453	89.8	0.2654	0.61	315	6050	RMT 84.36 NR 60.28	4700 2360	14900 7500
Canna/AAC/TW	397.5	16	0.1579	91.0	0.3135	0.66	373	7000	RMT 84.36 NR 60.28	4690 2350	12600 6300
Cosmos/AAC/TW	477.0	16	0.1730	91.1	0.3760	0.72	447	8390	RMT 84.36 NR 60.28	4690 2370	10500 5300
Zinnia/AAC/TW	500	16	0.1771	92.3	0.3940	0.74	469	8790	RMT 84.36 NR 60.28	4690 2340	10000 5000
Mistletoe/AAC/TW	556.5	16	0.1868	92.6	0.4387	0.78	522	9790	RMT 84.36 NR 60.28	4690 2350	9000 4500
Meadowsweet/AAC/TW	600	16	0.1940	93.0	0.4729	0.80	562	10500	RMT 84.36 NR 60.28	4720 2360	8400 4200
Orchid/AAC/TW	636	16	0.1996	93.4	0.5007	0.83	596	11200	RMT 84.36 RM 68.38	4710 2320	7900 3900
Verbena/AAC/TW	700	16	0.2095	93.8	0.5514	0.86	656	12300	RMT 84.36 NR 60.28	4720 2360	7200 3600
Nasturtium/AAC/TW	750	16	0.2168	94.0	0.5908	0.89	703	12900	RMT 84.36 NR 60.28	4710 2390	6700 3400
Arbutus/AAC/TW	795	16	0.2231	94.1	0.6257	0.92	745	13600	RMT 84.36 NR 60.28	4690 2380	6300 3200
Cockscomb/AAC/TW	900	16	0.2376	91.8	0.7092	0.99	844	15400	RMT 84.36 NR 60.28	4720 2360	5600 2800
Magnolia/AAC/TW	954	31	0.1756	92.0	0.7509	1.02	894	16400	RMT 96.60 RMT 84.36	9120 4560	10200 5100
Hawkweed/AAC/TW	1000	31	0.1798	92.3	0.7868	1.04	937	17200	RMT 96.60 RMT 84.36	9090 4590	9700 4900
Bluebell/AAC/TW	1033.5	31	0.1827	92.5	0.8130	1.06	969	17700	RMT 96.60 RMT 84.36	9110 4550	9400 4700
Marigold/AAC/TW	1113	31	0.1897	92.8	0.8759	1.10	1043	19100	RMT 96.60 RMT 84.36	9080 4590	8700 4400
Hawthorn/AAC/TW	1192.5	31	0.1963	93.1	0.9382	1.13	1118	20500	RMT 96.60 RMT 84.36	9170 4580	8200 4100
Narcissus/AAC/TW	1272	31	0.2027	93.2	1.0006	1.17	1192	21800	RMT 96.60 RMT 84.36	9060 4530	7600 3800
Columbine/AAC/TW	1351.5	31	0.2090	93.6	1.0634	1.20	1267	23200	RMT 96.60 RMT 84.36	9120 4560	7200 3600
Carnation/AAC/TW	1431	31	0.2151	93.7	1.1260	1.24	1341	24000	RMT 96.60 RMT 84.36	9120 4560	6800 3400
Coreopsis/AAC/TW	1590	51	0.1767	91.9	1.2508	1.32	1490	27000	RMT 96.60 RMT 90.45	9980 7450	6700 5000
Jessamine/AAC/TW	1750	51	0.1853	92.3	1.3760	1.38	1640	29700	RMT 96.60 RMT 90.45	10010 7550	6100 4600
Cowslip/AAC/TW	2000	51	0.1981	92.8	1.5720	1.47	1875	33900	RMT 96.60 RMT 90.45	10030 7570	5300 4000
Lupine/AAC/TW	2500	71	0.1877	92.1	1.9655	1.65	2366	41900	RMT 108.74 RMT 96.60	19400 10410	8200 4400
Trillium/AAC/TW	3000	71	0.2056	92.7	2.3565	1.80	2839	50300	RMT 108.74 RMT 96.60	20070 10320	7000 3600

(1) Weights shown are for conductor only and do not include the reel. Normal length and shipping tolerances apply.

Dimensions and weights not designated minimum or maximum are nominal values and subject to manufacturing tolerances. In this context, weight means mass.

TransPwr[®] AAC/TW Bare Overhead Conductor

Trapezoidal All-Aluminum 1350 Concentric-Lay-Stranded

AAC/TW CONDUCTORS (ELECTRICAL PROPERTIES) – REDUCED DIAMETER – CONDUCTORS SIZED TO HAVE EQUIVALENT CIRCULAR MIL AREA TO REGULAR AAC

CODE WORD	SIZE kcmil	NO. OF AL WIRES	EQUIVALENT STRAND WIRE DIA. INCHES	FILL FACTOR	CROSS-SECTION SQ. INCHES	O.D. INCHES	RESISTANCE (2) OHMS/1000 FT			AMPACITY 75°C (3)	GEOMETRIC MEAN RADIUS FT	INDUCTIVE REACTANCE OHM/1000 FT (4)	CAPACITIVE REACTANCE MEGA OHM 1000 FT (4)
							DC @ 20°C	AC @ 25°C	AC @ 75°C				
Tulip/AAC/TW	336.4	16	0.1453	89.8	0.2654	0.61	0.0514	0.0526	0.0630	500	0.0193	0.0907	0.5751
Canna/AAC/TW	397.5	16	0.1579	91.0	0.3135	0.66	0.0435	0.0446	0.0534	555	0.0209	0.0889	0.5630
Cosmos/AAC/TW	477	16	0.1730	91.1	0.3760	0.72	0.0362	0.0373	0.0445	625	0.0228	0.0869	0.5488
Zinnia/AAC/TW	500	16	0.1771	92.3	0.3940	0.74	0.0346	0.0356	0.0425	640	0.0232	0.0865	0.5461
Mistletoe/AAC/TW	556.5	16	0.1868	92.6	0.4387	0.78	0.0311	0.0320	0.0382	685	0.0245	0.0852	0.5380
Meadowsweet/AAC/TW	600	16	0.1940	93.0	0.4729	0.80	0.0288	0.0298	0.0355	715	0.0254	0.0844	0.5324
Orchid/AAC/TW	636	16	0.1996	93.4	0.5007	0.83	0.0272	0.0281	0.0335	745	0.0261	0.0838	0.5282
Verbena/AAC/TW	700	16	0.2095	93.8	0.5514	0.86	0.0247	0.0256	0.0305	790	0.0273	0.0827	0.5210
Nasturtium/AAC/TW	750	16	0.2168	94.0	0.5908	0.89	0.0230	0.0240	0.0286	820	0.0282	0.0820	0.5157
Arbutus/AAC/TW	795	16	0.2231	94.1	0.6257	0.92	0.0217	0.0227	0.0270	850	0.0291	0.0813	0.5112
Cockscomb/AAC/TW	900	16	0.2376	91.8	0.7092	0.99	0.0192	0.0201	0.0239	925	0.0313	0.0796	0.4997
Magnolia/AAC/TW	954	31	0.1756	92.0	0.7509	1.02	0.0181	0.0191	0.0226	955	0.0326	0.0787	0.4951
Hawkweed/AAC/TW	1000	31	0.1798	92.3	0.7868	1.04	0.0173	0.0182	0.0216	985	0.0333	0.0782	0.4917
Bluebell/AAC/TW	1033.5	31	0.1827	92.5	0.8130	1.06	0.0167	0.0177	0.0210	1005	0.0338	0.0778	0.4892
Marigold/AAC/TW	1113	31	0.1897	92.8	0.8759	1.10	0.0155	0.0165	0.0195	1050	0.0350	0.0770	0.4837
Hawthorn/AAC/TW	1192.5	31	0.1963	93.1	0.9382	1.13	0.0145	0.0155	0.0183	1095	0.0362	0.0763	0.4785
Narcissus/AAC/TW	1272	31	0.2027	93.2	1.0006	1.17	0.0136	0.0146	0.0173	1135	0.0374	0.0755	0.4736
Columbine/AAC/TW	1351.5	31	0.2090	93.6	1.0634	1.20	0.0128	0.0139	0.0163	1175	0.0384	0.0749	0.4691
Carnation/AAC/TW	1431	31	0.2151	93.7	1.1260	1.24	0.0121	0.0132	0.0155	1215	0.0395	0.0742	0.4647
Coreopsis/AAC/TW	1590	51	0.1767	91.9	1.2508	1.32	0.0109	0.0120	0.0141	1295	0.0423	0.0727	0.4549
Jessamine/AAC/TW	1750	51	0.1853	92.3	1.3760	1.38	0.00988	0.0111	0.0129	1370	0.0443	0.0716	0.4478
Cowslip/AAC/TW	2000	51	0.1981	92.8	1.5720	1.47	0.00864	0.00994	0.0115	1475	0.0472	0.0702	0.4377
Lupine/AAC/TW	2500	71	0.1877	92.1	1.9655	1.65	0.00698	0.00844	0.00969	1660	0.0531	0.0675	0.4196
Trillium/AAC/TW	3000	71	0.2056	92.7	2.3565	1.80	0.00582	0.00743	0.00843	1820	0.0580	0.0654	0.4059

(2) Based on a conductivity of 61.2% (minimum lot average) IACS at 20°C. To convert to ohms/mile, multiply by 5.28. To convert to ohms/km, multiply by 3.281.

(3) Based on a conductor temperature of 75°C at 60 Hz and the following conditions: 25°C ambient temperature, 2 ft/sec crosswind (90° to conductor), 0.5 coefficient of emissivity, 0.5 coefficient of absorptivity, 30° northern latitude, sea level elevation, 90° azimuth of line (East-West), clear atmosphere, and a date and time of noon on July 1 (resulting in 96.0 W/ft² of solar and sky radiated heat). Actual ampacity will differ based on local conditions. For specific ampacities, please contact your General Cable sales representative.

(4) Values for inductive reactance and capacitive reactance are expressed in terms of a 1 ft radius.



TransPowr® AAC/TW Bare Overhead Conductor

Trapezoidal All-Aluminum 1350 Concentric-Lay-Stranded

AAC/TW CONDUCTORS (MECHANICAL PROPERTIES) – REDUCED DIAMETER – CONDUCTORS SIZED TO HAVE EQUIVALENT CIRCULAR MIL AREA TO REGULAR AAC

CODE WORD	SIZE AWG OR kcmil	NO. OF AL WIRES	EQUIVALENT STRAND WIRE DIA. INCHES	FILL FACTOR	CROSS-SECTION SQ. INCHES	O.D. INCHES	APPROX. WEIGHT LB/1000 FT	RATED STRENGTH LBS	STANDARD PACKAGES (1)		
									REEL DESIGNATION	WEIGHT LBS	LENGTH FT
Logan/AAC/TW	322.5	16	0.1423	89.5	0.2546	0.60	302	5800	RMT 84.36 NR 60.28	4720 2360	15600 7800
- none -	384.5	16	0.1553	91.0	0.3032	0.65	360	6700	RMT 84.36 NR 60.28	4720 2340	13100 6500
Wheeler/AAC/TW	449.4	16	0.1679	91.7	0.3542	0.70	421	7900	RMT 84.36 NR 60.28	4720 2360	11200 5600
- none -	521.7	16	0.1808	92.7	0.4108	0.75	489	9100	RMT 84.36 NR 60.28	4690 2350	9600 4800
Robson/AAC/TW	595.8	16	0.1933	93.0	0.4693	0.80	558	10400	RMT 84.36 NR 60.28	4690 2350	8400 4200
- none -	678.2	16	0.2062	93.8	0.5343	0.85	636	11900	RMT 84.36 NR 60.28	4700 2350	7400 3700
McKinley/AAC/TW	761.5	16	0.2184	94.0	0.5995	0.90	714	13100	RMT 84.36 RM 68.38	4710 2360	6600 3300
- none -	854.2	16	0.2314	94.6	0.6726	0.95	801	14700	RMT 84.36 NR 60.28	4720 2320	5900 2900
Rainier/AAC/TW	918.8	31	0.1723	91.8	0.7227	1.00	861	15800	RMT 96.60 RMT 84.36	9130 4560	10600 5300
- none -	1020	31	0.1815	92.5	0.8023	1.05	956	17500	RMT 96.60 RMT 84.36	9080 4590	9500 4800
Helens/AAC/TW	1123.1	31	0.1905	92.8	0.8839	1.10	1053	19300	RMT 96.60 RMT 84.36	9160 4530	8700 4300
- none -	1234.2	31	0.1997	93.3	0.9707	1.15	1157	21200	RMT 96.60 RMT 84.36	9140 4510	7900 3900
Mazama/AAC/TW	1346.8	31	0.2085	93.5	1.0588	1.20	1262	23100	RMT 96.60 RMT 84.36	9090 4540	7200 3600
- none -	1467.9	31	0.2177	93.9	1.1542	1.25	1376	24700	RMT 96.60 RMT 84.36	9080 4540	6600 3300
Hood/AAC/TW	1583.2	31	0.2262	93.6	1.2457	1.30	1484	26600	RMT 96.60 RMT 84.36	9050 4600	6100 3100
- none -	1682.7	51	0.1817	92.3	1.3225	1.35	1577	28500	RMT 96.60 RMT 90.45	9940 7570	6300 4800
Whitney/AAC/TW	1812.7	51	0.1886	92.5	1.4243	1.40	1699	30800	RMT 96.60 RMT 90.45	10020 7480	5900 4400
- none -	1954.3	51	0.1959	92.9	1.5370	1.45	1832	33200	RMT 96.60 RMT 90.45	10070 7510	5500 4100
Powell/AAC/TW	2093.6	51	0.2027	93.0	1.6456	1.50	1982	35500	RMT 96.60 RMT 90.45	9910 7530	5000 3800
- none -	2245.4	51	0.2099	93.5	1.7653	1.55	2125	38100	RMT 96.60 RMT 90.45	9990 7440	4700 3500
Jefferson/AAC/TW	2388.1	51	0.2165	93.2	1.8782	1.60	2260	39700	RMT 96.60 RMT 90.45	9950 7460	4400 3300
- none -	2514.8	71	0.1883	92.4	1.9771	1.65	2380	42200	RMT 108.74 RMT 96.60	19520 10470	8200 4400
Shasta/AAC/TW	2667.2	71	0.1939	92.2	2.0957	1.70	2524	44700	RMT 108.74 RMT 96.60	19690 10350	7800 4100
- none -	2844.5	71	0.2003	92.9	2.2362	1.75	2692	47700	RMT 108.74 RMT 96.60	18850 10500	7000 3900
Adams/AAC/TW	3006.2	71	0.2058	92.7	2.3623	1.80	2873	50400	RMT 108.74 RMT 96.60	20110 10340	7000 3600

(1) Weights shown are for conductor only and do not include the reel. Normal length and shipping tolerances apply.

Dimensions and weights not designated minimum or maximum are nominal values and subject to manufacturing tolerances. In this context, weight means mass.

TransPwr[®] AAC/TW Bare Overhead Conductor

Trapezoidal All-Aluminum 1350 Concentric-Lay-Stranded

AAC/TW CONDUCTORS (ELECTRICAL PROPERTIES) – REDUCED DIAMETER – CONDUCTORS SIZED TO HAVE EQUIVALENT CIRCULAR MIL AREA TO REGULAR AAC

CODE WORD	SIZE AWG OR kcmil	NO. OF AL WIRES	EQUIVALENT STRAND WIRE DIA. INCHES	FILL FACTOR	CROSS-SECTION SQ. INCHES	O.D. INCHES	RESISTANCE (2) OHMS/1000 FT			AMPACITY 75°C (3)	GEOMETRIC MEAN RADIUS FT	INDUCTIVE REACTANCE OHM/1000 FT (4)	CAPACITIVE REACTANCE MEGA OHM 1000 FT (4)
							DC @ 20°C	AC @ 25°C	AC @ 75°C				
Logan/AAC/TW	322.5	16	0.1423	89.5	0.2546	0.60	0.0536	0.0549	0.0657	490	0.0189	0.0912	0.5782
- none -	384.5	16	0.1553	91.0	0.3032	0.65	0.0450	0.0461	0.0551	545	0.0205	0.0893	0.5656
Wheeler/AAC/TW	449.4	16	0.1679	91.7	0.3542	0.70	0.0385	0.0395	0.0472	600	0.0221	0.0876	0.5540
- none -	521.7	16	0.1808	92.7	0.4108	0.75	0.0331	0.0341	0.0408	660	0.0237	0.0860	0.5431
Robson/AAC/TW	595.8	16	0.1933	93.0	0.4693	0.80	0.0290	0.0300	0.0358	715	0.0253	0.0845	0.5330
- none -	678.2	16	0.2062	93.8	0.5343	0.85	0.0255	0.0264	0.0315	775	0.0269	0.0831	0.5234
McKinley/AAC/TW	761.5	16	0.2184	94.0	0.5995	0.90	0.0227	0.0236	0.0281	830	0.0285	0.0818	0.5145
- none -	854.2	16	0.2314	94.6	0.6726	0.95	0.0202	0.0212	0.0252	890	0.0300	0.0805	0.5060
Rainier/AAC/TW	918.8	31	0.1723	91.8	0.7227	1.00	0.0188	0.0198	0.0235	935	0.0320	0.0791	0.4979
- none -	1020	31	0.1815	92.5	0.8023	1.05	0.0169	0.0179	0.0212	995	0.0336	0.0780	0.4903
Helens/AAC/TW	1123.1	31	0.1905	92.8	0.8839	1.10	0.0154	0.0164	0.0194	1055	0.0352	0.0769	0.4830
- none -	1234.2	31	0.1997	93.3	0.9707	1.15	0.0140	0.0150	0.0177	1115	0.0368	0.0759	0.4760
Mazama/AAC/TW	1346.8	31	0.2085	93.5	1.0588	1.20	0.0128	0.0139	0.0164	1175	0.0384	0.0749	0.4693
- none -	1467.9	31	0.2177	93.9	1.1542	1.25	0.0118	0.0129	0.0151	1235	0.0400	0.0740	0.4629
Hood/AAC/TW	1583.2	31	0.2262	93.6	1.2457	1.30	0.0109	0.0121	0.0141	1290	0.0416	0.0731	0.4567
- none -	1682.7	51	0.1817	92.3	1.3225	1.35	0.0103	0.0115	0.0134	1340	0.0434	0.0721	0.4508
Whitney/AAC/TW	1812.7	51	0.1886	92.5	1.4243	1.40	0.00954	0.0108	0.0125	1395	0.0450	0.0712	0.4452
- none -	1954.3	51	0.1959	92.9	1.5370	1.45	0.00884	0.0101	0.0118	1455	0.0467	0.0704	0.4396
Powell/AAC/TW	2093.6	51	0.2027	93.0	1.6456	1.50	0.00834	0.00966	0.0112	1505	0.0483	0.0697	0.4343
- none -	2245.4	51	0.2099	93.5	1.7653	1.55	0.00777	0.00915	0.0106	1565	0.0498	0.0689	0.4292
Jefferson/AAC/TW	2388.1	51	0.2165	93.2	1.8782	1.60	0.00731	0.00873	0.0100	1615	0.0515	0.0682	0.4242
- none -	2514.8	71	0.1883	92.4	1.9771	1.65	0.00694	0.00841	0.00964	1665	0.0532	0.0674	0.4194
Shasta/AAC/TW	2667.2	71	0.1939	92.2	2.0957	1.70	0.00654	0.00806	0.00921	1715	0.0548	0.0667	0.4146
- none -	2844.5	71	0.2003	92.9	2.2362	1.75	0.00614	0.00770	0.00877	1770	0.0564	0.0661	0.4102
Adams/AAC/TW	3006.2	71	0.2058	92.7	2.3623	1.80	0.00586	0.00746	0.00848	1815	0.0581	0.0654	0.4057

(2) Based on a conductivity of 61.2% (minimum lot average) IACS at 20°C. To convert to ohms/mile, multiply by 5.28. To convert to ohms/km, multiply by 3.281.

(3) Based on a conductor temperature of 75°C at 60 Hz and the following conditions: 25°C ambient temperature, 2 ft/sec crosswind (90° to conductor), 0.5 coefficient of emissivity, 0.5 coefficient of absorbtivity, 30° northern latitude, sea level elevation, 90° azimuth of line (East-West), clear atmosphere, and a date and time of noon on July 1 (resulting in 96.0 W/ft² of solar and sky radiated heat). Actual ampacity will differ based on local conditions. For specific ampacities, please contact your General Cable sales representative.

(4) Values for inductive reactance and capacitive reactance are expressed in terms of a 1 ft radius.



Notes

TransPowr® A2 (AASC) Bare Overhead Conductor

Aluminum Alloy Conductor Concentric-Lay-Stranded

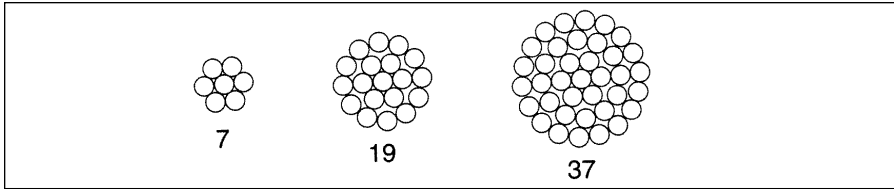

Product Construction:

Complete Conductor:

A2 conductors are high strength aluminum alloy, concentric-lay-stranded conductors. They are similar in construction and appearance to the A1 or AAC all-aluminum conductors. The conductors are manufactured in accordance with the requirements of the latest applicable issue of CAN/CSA C61089.

A2 or AASC (Aluminum Alloy Stranded Conductor) are CSA reference terms.

The A2/AASC conductors are manufactured from a heat-treated, magnesium-silicon high strength aluminum alloy.

The aluminum strands consist of a concentric stranded cable of 7, 19, 37, or more wires. The sizes and strandings listed on the following pages are common examples used in overhead lines.

Features and Benefits:

Aluminum alloy conductors have a number of advantages over the use of the ACSR or all-aluminum conductors.

- Lower power losses than for equivalent single aluminum layer ACSR conductors. (The inductive effect of the steel core in the ACSR is eliminated.)
- Simpler fittings than those required for ACSR.
- Excellent corrosion resistance in environments conducive to galvanic corrosion in ACSR.
- Strength and sags approximately the same as for equivalent 6/1 and 26/7 ACSR conductors.
- Outside diameters are the same as for standard ACSR conductors, permitting interchangeability of fittings.
- Greater resistance to abrasion than that for 1350 wires in all-aluminum or ACSR conductors.

Applications:

A2 aluminum alloy conductors are extensively used for overhead distribution and transmission lines adjacent to ocean coastlines where there can be a problem of corrosion in the steel of an ACSR construction.

The aluminum alloy conductors are used in place of single layer ACSR conductors (i.e., 6 AWG to 4/0 AWG) to reduce power losses in overhead distribution and transmission lines. The inductive effect of the ACSR's steel core is eliminated, hence increasing the operating efficiency of the line.

Option:

- Non-Specular surface finish (/NS)
- E3X® surface coating (/E3X)

For more information, contact your General Cable sales representative or e-mail info@generalcable.com.



TransPowr® A2 (AASC) Bare Overhead Conductor

Aluminum Alloy Conductor Concentric-Lay-Stranded

A2 (AASC), ALUMINUM ALLOY CONDUCTOR, CONCENTRIC-LAY-STRANDED (MECHANICAL PROPERTIES) - CONDUCTOR SIZED TO HAVE DIAMETER EQUAL TO ACSR

CODE WORD	CSA DESIGNATION	CONDUCTOR SIZE		EQUIVALENT ACSR SIZE (1)	EQUIVALENT ASC SIZE (2)	STRANDING NO. X DIA. (mm)	CLASS	O.D. (mm)	NOMINAL MASS KG/KM	RATED STRENGTH kN
		kcMil	mm ²							
-none-	8-A2-7	18.9	9.6	18.9	18.9	7x1.32	AA	3.96	26.15	2.92
Fredericton	13-A2-7	30.2	15.3	#6	#6	7x1.67	AA	5.01	41.86	4.68
Whitehorse	21-A2-7	48.0	24.3	#4	#4	7x2.10	AA	6.30	66.19	7.39
Halifax	34-A2-7	76.4	38.7	#2	#2	7x2.65	AA	7.95	105.4	11.8
Regina	42-A2-7	96.3	48.8	#1	#1	7x2.98	AA	8.94	133.3	14.9
Montreal	54-A2-7	121.5	61.6	1/0	1/0	7x3.35	AA	10.1	168.4	18.8
Winnipeg	67-A2-7	153.2	77.6	2/0	2/0	7x3.76	AA	11.3	212.2	23.7
Toronto	85-A2-7	193.1	97.9	3/0	3/0	7x4.22	AA	12.7	267.3	29.9
Vancouver	107-A2-7	243.5	123.4	4/0	4/0	7x4.74	AA	14.2	337.2	37.7
Calgary	135-A2-19	307.1	155.6	266.8	266.8	19x3.23	AA	16.2	426.8	47.5
Edmonton	170-A2-19	387.2	196.2	336.4	336.4	19x3.63	AA	18.2	539.1	60.0
Brockville	201-A2-19	457.5	231.8	397.5	397.5	19x3.94	AA	19.7	635.1	70.7
Quebec	242-A2-19	549.0	278.2	477	477	19x4.32	AA	21.6	763.5	84.9

(1) Equivalent ACSR Size refers to an ACSR conductor size of equal diameter.

(2) Equivalent ASC Size refers to an ASC (i.e., CSA C61089 A1) conductor of approximate equivalent electrical resistance.

Dimensions and weights not designated minimum or maximum are nominal values and subject to manufacturing tolerances. In this context, weight means mass.

TransPowr[®] A2 (AASC) Bare Overhead Conductor

Aluminum Alloy Conductor Concentric-Lay-Stranded

A2 (AASC), ALUMINUM ALLOY CONDUCTOR, CONCENTRIC-LAY-STRANDED (ELECTRICAL PROPERTIES) - CONDUCTOR SIZED TO HAVE DIAMETER EQUAL TO ACSR

CODE WORD	CONDUCTOR SIZE		RESISTANCE (3)OHMS/KM			AMPACITY @75°C (4)		GEOMETRIC MEAN RADIUS CM	INDUCTIVE REACTANCE OHM/KM (5)	CAPACITIVE REACTANCE MEGAOHM-KM (5)
	kcmil	mm ²	DC @20°C	AC @25°C	AC @75°C	STANDARD	E3X [®]			
-none-	18.9	9.6	3.433	3.493	4.093	73	78	0.143	0.4042	0.2404
Fredericton	30.2	15.3	2.154	2.192	2.568	98	105	0.183	0.3858	0.2293
Whitehorse	48.0	24.3	1.354	1.378	1.615	131	141	0.229	0.3688	0.2182
Halifax	76.4	38.7	0.8515	0.8665	1.015	175	191	0.290	0.3511	0.2071
Regina	96.3	48.8	0.6751	0.6871	0.8052	202	222	0.323	0.3429	0.2016
Montreal	121.5	61.6	0.5350	0.5445	0.6382	234	258	0.366	0.3333	0.1960
Winnipeg	153.2	77.6	0.4245	0.4321	0.5064	270	299	0.408	0.3251	0.1905
Toronto	193.1	97.9	0.3367	0.3428	0.4017	313	348	0.460	0.3163	0.1850
Vancouver	243.5	123.4	0.2670	0.2720	0.3187	362	404	0.515	0.3078	0.1795
Calgary	307.1	155.6	0.2127	0.2168	0.2540	418	471	0.613	0.2946	0.1734
Edmonton	387.2	196.2	0.1687	0.1722	0.2016	484	548	0.686	0.2861	0.1678
Brockville	457.5	231.8	0.1428	0.1459	0.1708	537	611	0.747	0.2795	0.1638
Quebec	549.0	278.2	0.1190	0.1218	0.1425	602	688	0.817	0.2730	0.1595

(3) Based on a conductivity of 53.0% IACS at 20°C for aluminum.

(4) Based on a conductor temperature of 75°C at 60 Hz and the following conditions, 32°C ambient temperature, 1.98 ft/sec (0.6 m/sec) crosswind (90° to conductor), 0.5 coefficient of emissivity for a standard conductor and 0.9 for a E3X coated conductor, 0.5 coefficient of absorptivity for a standard conductor and 0.2 for a E3X coated conductor, 42° northern latitude, sea level elevation, 90° azimuth of line (East-West), clear atmosphere, and a date and time of noon on July 1 (resulting in 95.0 W/ft² of solar and sky radiated heat). Actual ampacity will differ based on local conditions. For specific ampacities, please contact your General Cable sales representative.

(5) Values for inductive reactance and capacitive reactance are expressed in terms of a 1 ft radius (30.48 cm).



Notes



TransPowr® ACSR Bare Overhead Conductor

Aluminum Conductor Steel-Reinforced Concentric-Lay-Stranded

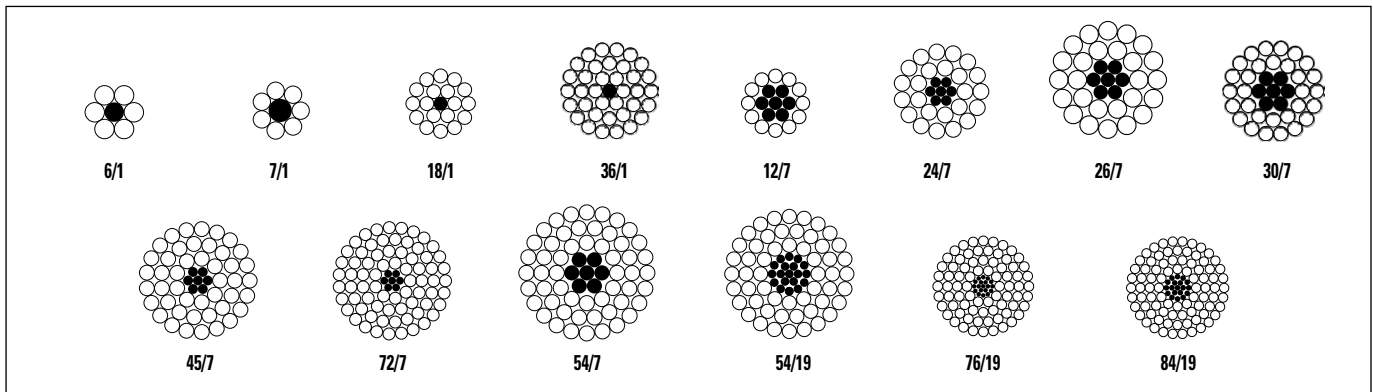

Product Construction:

Complete Conductor:

ACSR is a composite concentric-lay-stranded conductor. The conductors are manufactured in accordance with the requirements of the latest applicable issue of CAN/CSA C61089.

The steel strand or strands form the central core of the conductor, around which is stranded one or more layers of aluminum 1350-H19 wires.

The steel core may consist of a single strand or a concentric stranded cable of 7, 19, 37, or more wires. Numerous combinations of aluminum and steel strands and layers are possible. The sizes and strandings listed on the following pages are common examples used in overhead lines. Metric (mm²) sizes are also available.

The Canadian ACSR conductors are similar in design (strand component size and configuration) to the ACSR conductors designed to ASTM B232 specifications. Differences lie in the methods used to calculate the rated strength and dc resistance values.

CAN/CSA C61089 refers to ACSR as Type A1/S1A conductors, where the A1 refers to 1350 H19 aluminum and the S1A as Class A galvanized, regular strength steel.

Features and Benefits:

ACSR conductors are recognized for their record of economy, dependability and favorable strength/weight ratio. ACSR conductors combine the light weight and good conductivity of aluminum with the high tensile strength and ruggedness of steel. In line design, this can provide higher tensions, less sag, and longer span lengths than obtainable with most other types of overhead conductors. The steel strands are added as mechanical reinforcements. The cross-sections above illustrate some common strandings.

The steel core wires are protected from corrosion by galvanizing. The standard Class A zinc coating is usually adequate for ordinary environments. For greater protection, Class B coating may be specified. High Strength (S2A) or Extra High Strength (S3A) steel core with Class A galvanizing are also available.

The product is available with conductor corrosion inhibitor treatment applied to the central steel component.

Applications:

Aluminum Conductors, Steel-Reinforced (ACSR) are extensively used for overhead distribution and transmission lines.

Options:

- High-Conductivity aluminum (/HC) (62.2% IACS)
- CSA high-strength Class A galvanized steel core (S2A)
- CSA extra-high-strength Class A galvanized steel core (S3A)
- ASTM regular-strength Class A zinc-5% aluminum mischmetal alloy-coated steel core (/MA2 to ASTM B802)
- ASTM high-strength Class A zinc-5% aluminum mischmetal alloy-coated steel core (/MA3 to ASTM B803)
- Aluminum-clad steel core (20SA)
- Non-Specular surface finish (/NS)
- Aluminum Alloy Steel Reinforced Conductors (A2/SxA and A4/SxA) designs are available
- E3X® surface coating (/E3X)

For more information, contact your General Cable sales representative or e-mail info@generalcable.com.

TransPow[®] ACSR Bare Overhead Conductor

Aluminum Conductor Steel-Reinforced Concentric-Lay-Stranded

ACSR, ALUMINUM CONDUCTOR, STEEL REINFORCED, CONCENTRIC-LAY-STRANDED (MECHANICAL PROPERTIES)

CODE WORD (1)	CSA DESIGNATION	CONDUCTOR SIZE		STRANDING NO. X DIA. (mm)		CROSS-SECTION (mm ²)		O.D. (mm)	NOMINAL MASS KG/KM (2)			RATED STRENGTH kN
		AWG or kcmil	mm ²	AL	STEEL	TOTAL	AL		TOTAL	AL	STEEL	
Turkey	13-A1/S1A-6/1	#6	13.3	6x1.68	1x1.68	15.50	13.3	5.04	53.77	36.52	17.25	5.19
Swan	21-A1/S1A-6/1	#4	21.2	6x2.12	1x2.12	24.70	21.2	6.36	85.62	58.16	27.46	8.15
Swanate	21-A1/S1A-7/1	#4	21.1	7x1.96	1x2.61	26.50	21.1	6.53	99.52	57.89	41.62	10.2
Sparrow	34-A1/S1A-6/1	#2	33.6	6x2.67	1x2.67	39.20	33.6	8.01	139.2	92.25	46.97	12.4
Sparate	34-A1/S1A-7/1	#2	33.5	7x2.47	1x3.30	42.10	33.5	8.24	158.5	91.94	66.54	15.6
Robin	42-A1/S1A-6/1	#1	42.4	6x3.00	1x3.00	49.50	42.4	9.00	171.5	116.5	54.99	15.5
Raven	54-A1/S1A-6/1	1/0	53.5	6x3.37	1x3.37	62.40	53.5	10.1	216.4	147.0	69.40	18.9
Quail	67-A1/S1A-6/1	2/0	67.4	6x3.78	1x3.78	78.60	67.4	11.3	272.2	184.9	87.31	23.5
Pigeon	85-A1/S1A-6/1	3/0	85.0	6x4.25	1x4.25	99.30	85.0	12.8	344.1	233.7	110.4	29.6
Penguin	107-A1/S1A-6/1	4/0	107.2	6x4.77	1x4.77	125.1	107.2	14.3	433.4	294.4	139.0	37.3
Owl	135-A1/S1A-6/7	266.8	135.2	6x5.36	7x1.79	153.0	135.2	16.1	509.4	371.8	137.7	42.3
Waxwing	135-A1/S1A-18/1	266.8	135.2	18x3.09	1x3.09	142.5	135.2	15.5	430.1	371.8	58.34	31.2
Spoonbill	135-A1/S1A-22/7	266.8	135.2	22x2.80	7x1.55	148.7	135.5	15.9	477.1	373.8	103.2	39.2
Scaup	135-A1/S1A-24/7	266.8	135.2	24x2.68	7x1.79	153.0	135.4	16.1	511.6	373.9	137.7	45.0
Partridge	135-A1/S1A-26/7	266.8	135.2	26x2.57	7x2.00	156.9	135.2	16.3	544.6	372.8	171.9	50.0
Junco	136-A1/S1A-30/7	266.8	135.2	30x2.40	7x2.40	167.4	135.7	16.8	623.1	375.6	247.5	61.2
Phoebe	152-A1/S1A-18/1	300	152.0	18x3.28	1x3.28	160.5	152.0	16.4	484.6	418.9	65.74	35.2
Piper	152-A1/S1A-30/7	300	152.0	30x2.54	7x2.54	187.5	152.0	17.8	697.9	420.7	277.2	67.8
Ostrich	152-A1/S1A-26/7	300	152.0	26x2.73	7x2.12	176.9	152.0	17.3	613.7	420.6	193.1	56.3
Merlin	171-A1/S1A-18/1	336.4	170.5	18x3.47	1x3.47	179.7	170.5	17.4	542.4	468.8	73.57	39.3
Woodcock	171-A1/S1A-22/7	336.4	170.5	22x3.14	7x1.74	187.0	170.4	17.8	600.2	470.1	130.1	48.4
Widgeon	171-A1/S1A-24/7	336.4	170.5	24x3.01	7x2.00	192.8	170.8	18.0	643.5	471.6	171.9	54.8
Linnet	170-A1/S1A-26/7	336.4	170.5	26x2.89	7x2.25	198.4	170.5	18.3	688.9	471.4	217.5	62.4
Oriole	171-A1/S1A-30/7	336.4	170.5	30x2.69	7x2.69	210.3	170.5	18.8	782.8	471.9	310.9	76.0
Chickadee	201-A1/S1A-18/1	397.5	201.4	18x3.77	1x3.77	212.1	201.4	18.9	640.3	553.4	86.85	45.4
Stork	201-A1/S1A-22/7	397.5	201.4	22x3.41	7x1.90	220.8	200.9	19.3	709.6	554.5	155.1	57.4
Brant	202-A1/S1A-24/7	397.5	201.4	24x3.27	7x2.18	227.7	201.6	19.6	760.8	556.6	204.2	64.8
Ibis	201-A1/S1A-26/7	397.5	201.4	26x3.14	7x2.44	234.1	201.4	19.9	812.3	556.5	255.8	71.5
Lark	201-A1/S1A-30/7	397.5	201.4	30x2.92	7x2.92	247.8	201.4	20.4	922.4	556.0	366.4	88.6
Pelican	242-A1/S1A-18/1	477	241.7	18x4.13	1x4.13	254.5	241.7	20.7	768.4	664.2	104.2	54.5
Toucan	242-A1/S1A-22/7	477	241.7	22x3.74	7x2.08	265.5	241.7	21.2	852.9	667.0	185.9	68.9
Flicker	242-A1/S1A-24/7	477	241.7	24x3.58	7x2.39	273.0	241.6	21.5	912.6	667.2	245.4	76.9
Hawk	242-A1/S1A-26/7	477	241.7	26x3.44	7x2.67	280.8	241.7	21.8	974.2	667.9	306.3	85.8
Hen	242-A1/S1A-30/7	477	241.7	30x3.20	7x3.20	297.6	241.7	22.4	1108	667.8	440.0	103
Heron	253-A1/S1A-30/7	500	253.4	30x3.28	7x3.28	312.6	253.4	23.0	1164	701.6	462.3	108
Osprey	282-A1/S1A-18/1	556.5	282.0	18x4.47	1x4.47	298.2	282.5	22.4	900.1	778.0	122.1	63.9
Sapsucker	282-A1/S1A-22/7	556.5	282.0	22x4.04	7x2.24	309.6	282.0	22.9	993.9	778.3	215.6	78.8
Parakeet	282-A1/S1A-24/7	556.5	282.0	24x3.87	7x2.58	318.9	282.3	23.2	1066	779.7	286.0	88.3
Dove	282-A1/S1A-26/7	556.5	282.0	26x3.72	7x2.89	328.5	282.0	23.6	1140	781.0	358.9	100
Eagle	282-A1/S1A-30/7	556.5	282.0	30x3.46	7x3.46	347.9	282.0	24.2	1295	780.7	514.4	120
-none-	307-A1/S1A-22/7	605	306.6	22x4.21	7x2.34	336.4	306.6	23.9	1080	845.2	235.3	84.8
Peacock	306-A1/S1A-24/7	605	306.6	24x4.03	7x2.69	345.9	306.1	24.2	1156	845.5	310.9	95.9
Squab	306-A1/S1A-26/7	605	306.6	26x3.87	7x3.01	355.6	305.8	24.5	1235	845.3	389.3	107
Wood Duck	307-A1/S1A-30/7	605	306.6	30x3.61	7x3.61	378.7	307.1	25.3	1410	849.9	560.0	131
Duck	307-A1/S1A-54/7	605	306.6	54x2.69	7x2.69	346.7	306.6	24.2	1163	852.6	310.9	101

(1) Code words shown denote ACSR with regular-strength Class A galvanized steel core (S1A). See the Options section to find the appropriate code word modifier designation for alternative design options.

(2) Due to rounding, total values may be slightly greater or slightly less than the sum of the component values.

Dimensions and weights not designated minimum or maximum are nominal values and subject to manufacturing tolerances. In this context, weight means mass.

TransPowr® ACSR Bare Overhead Conductor

Aluminum Conductor Steel-Reinforced Concentric-Lay-Stranded

ACSR, ALUMINUM CONDUCTOR, STEEL REINFORCED, CONCENTRIC-LAY-STRANDED (ELECTRICAL PROPERTIES)

CODE WORD	CONDUCTOR SIZE		PERCENT BY MASS		RESISTANCE (3)OHMS/KM			AMPACITY @75°C (4)		GEOMETRIC MEAN RADIUS CM	INDUCTIVE REACTANCE OHM/KM (5)	CAPACITIVE REACTANCE MEGAOHM-KM (5)
	AWG OR kcmil	mm ²	AL	STEEL	DC @20°C	AC @25°C	AC @75°C	STANDARD	E3X®			
Turkey	#6	13.3	67.92%	32.08%	2.160	2.204	2.76	95	102	0.055	0.476	0.2290
Swan	#4	21.2	67.93%	32.07%	1.357	1.384	1.76	126	136	0.082	0.446	0.2179
Swanate	#4	21.1	58.17%	41.82%	1.355	1.382	1.78	126	136	0.086	0.441	0.2165
Sparrow	#2	33.6	66.27%	33.74%	0.8528	0.8701	1.14	166	181	0.124	0.415	0.2068
Sparate	#2	33.5	58.01%	41.98%	0.8512	0.8685	1.14	167	182	0.131	0.410	0.2054
Robin	#1	42.4	67.93%	32.06%	0.6766	0.6904	0.902	192	210	0.170	0.390	0.2012
Raven	1/0	53.5	67.93%	32.07%	0.5359	0.5469	0.736	219	241	0.186	0.384	0.1957
Quail	2/0	67.4	67.93%	32.08%	0.4257	0.4344	0.594	251	277	0.220	0.372	0.1902
Pigeon	3/0	85.0	67.92%	32.08%	0.3376	0.3446	0.480	287	320	0.264	0.359	0.1847
Penguin	4/0	107.2	67.93%	32.07%	0.2676	0.2732	0.389	328	368	0.312	0.346	0.1791
Owl	266.8	135.2	72.99%	27.03%	0.2122	0.2168	0.301	385	436	0.386	0.327	0.1735
Waxwing	266.8	135.2	86.45%	13.56%	0.2127	0.2174	0.2603	409	459	0.600	0.2963	0.1754
Spoonbill	266.8	135.2	78.35%	21.63%	0.2134	0.2181	0.2611	411	462	0.631	0.2923	0.1742
Scaup	266.8	135.2	73.08%	26.92%	0.2136	0.2182	0.2613	412	464	0.646	0.2907	0.1736
Partridge	266.8	135.2	68.45%	31.56%	0.2136	0.2182	0.2613	413	466	0.661	0.2887	0.1729
Junco	266.8	135.2	60.28%	39.72%	0.2140	0.2185	0.2617	416	469	0.692	0.2854	0.1716
Phoebe	300	152.0	86.44%	13.57%	0.1893	0.1936	0.2318	440	495	0.637	0.2917	0.1726
Piper	300	152.0	60.28%	39.72%	0.1903	0.1944	0.2327	448	507	0.735	0.2809	0.1688
Ostrich	300	152.0	68.54%	31.46%	0.1900	0.1942	0.2325	445	503	0.701	0.2845	0.1701
Merlin	336.4	170.5	86.43%	13.56%	0.1689	0.1728	0.2068	472	534	0.674	0.2874	0.1699
Woodcock	336.4	170.5	78.32%	21.68%	0.1691	0.1729	0.2070	475	538	0.707	0.2838	0.1687
Widgeon	336.4	170.5	73.29%	26.71%	0.1693	0.1731	0.2072	476	540	0.725	0.2818	0.1681
Linnet	336.4	170.5	68.43%	31.57%	0.1696	0.1734	0.2076	478	542	0.744	0.2799	0.1674
Oriole	336.4	170.5	60.28%	39.72%	0.1696	0.1734	0.2076	481	546	0.777	0.2766	0.1660
Chickadee	397.5	201.4	86.43%	13.56%	0.1429	0.1464	0.1752	524	595	0.732	0.2812	0.1659
Stork	397.5	201.4	78.14%	21.86%	0.1432	0.1466	0.1755	527	599	0.768	0.2776	0.1647
Brant	397.5	201.4	73.16%	26.84%	0.1433	0.1466	0.1755	529	602	0.789	0.2756	0.1641
Ibis	397.5	201.4	68.51%	31.49%	0.1435	0.1468	0.1757	530	604	0.808	0.2736	0.1634
Lark	397.5	201.4	60.28%	39.72%	0.1436	0.1469	0.1758	534	609	0.844	0.2704	0.1621
Pelican	477	241.7	86.44%	13.56%	0.1191	0.1223	0.1462	587	670	0.802	0.2743	0.1616
Toucan	477	241.7	78.20%	21.80%	0.1194	0.1224	0.1464	591	675	0.841	0.2707	0.1603
Flicker	477	241.7	73.11%	26.89%	0.1194	0.1223	0.1464	593	678	0.863	0.2687	0.1597
Hawk	477	241.7	68.56%	31.44%	0.1196	0.1225	0.1466	594	680	0.884	0.2671	0.1591
Hen	477	241.7	60.27%	39.71%	0.1196	0.1225	0.1466	599	686	0.927	0.2635	0.1577
Heron	500	253.4	60.27%	39.72%	0.1142	0.1169	0.1399	617	708	0.948	0.2618	0.1566
Osprey	556.5	282.0	86.43%	13.57%	0.1021	0.1051	0.1256	646	741	0.866	0.2684	0.1579
Sapsucker	556.5	282.0	78.31%	21.69%	0.1023	0.1051	0.1257	650	746	0.908	0.2648	0.1567
Parakeet	556.5	282.0	73.14%	26.83%	0.1023	0.1050	0.1256	653	750	0.933	0.2628	0.1560
Dove	556.5	282.0	68.51%	31.48%	0.1024	0.1051	0.1257	655	753	0.954	0.2612	0.1554
Eagle	556.5	282.0	60.29%	39.72%	0.1026	0.1051	0.1258	660	759	1.000	0.2576	0.1540
-none-	605	306.6	78.26%	21.79%	0.09410	0.09680	0.1157	685	788	0.948	0.2618	0.1547
Peacock	605	306.6	73.14%	26.89%	0.09410	0.09672	0.1156	688	792	0.972	0.2599	0.1540
Squab	605	306.6	68.45%	31.52%	0.09426	0.09681	0.1157	690	795	0.997	0.2579	0.1534
Wood Duck	605	306.6	60.28%	39.72%	0.09435	0.09679	0.1158	695	802	1.040	0.2546	0.1520
Duck	605	306.6	73.31%	26.73%	0.09460	0.09722	0.1162	686	790	0.981	0.2592	0.1540

(3) Based on a conductivity of 61.0% IACS at 20°C for aluminum. Per CSA C61089, the conductivity of the steel is not to be factored in. For the AWG sizes of ACSR, the approximated hysteresis losses in the steel are included.
 (4) Based on a conductor temperature of 75°C at 60 Hz and the following conditions, 32°C ambient temperature, 1.98 ft/sec (0.6 m/sec) crosswind (90° to conductor), 0.5 coefficient of emissivity for a standard conductor and 0.9 for a E3X coated conductor, 0.5 coefficient of absorptivity for a standard conductor and 0.2 for a E3X coated conductor, 42° northern latitude, sea level elevation, 90° azimuth of line (East-West), clear atmosphere, and a date and time of noon on July 1 (resulting in 95.0 W/ft² of solar and sky radiated heat). Actual ampacity will differ based on local conditions. For specific ampacities, please contact your General Cable sales representative.
 (5) Values for inductive reactance and capacitive reactance are expressed in terms of a 1 ft radius (30.48 cm).



TransPowr® ACSR Bare Overhead Conductor

Aluminum Conductor Steel-Reinforced Concentric-Lay-Stranded

ACSR, ALUMINUM CONDUCTOR, STEEL REINFORCED, CONCENTRIC-LAY-STRANDED (MECHANICAL PROPERTIES)

CODE WORD (1)	CSA DESIGNATION	CONDUCTOR SIZE		STRANDING NO. X DIA. (mm)		GROSS-SECTION (mm ²)		O.D. (mm)	NOMINAL MASS KG/KM (2)			RATED STRENGTH kN
		AWG or kcmil	mm ²	AL	STEEL	TOTAL	AL		TOTAL	AL	STEEL	
Kingbird	323-A1/S1A-18/1	636	322.3	18x4.78	1x4.78	341.0	323.0	23.9	1029	889.7	139.6	73.0
Goldfinch	322-A1/S1A-22/7	636	322.3	22x4.32	7x2.40	354.1	322.3	24.5	1137	889.9	247.5	89.3
Rook	323-A1/S1A-24/7	636	322.3	24x4.14	7x2.76	365.0	323.1	24.8	1220	892.2	327.3	101
Grosbeak	322-A1/S1A-26/7	636	322.3	26x3.97	7x3.09	374.3	322.3	25.2	1300	889.5	410.3	111
Scoter	323-A1/S1A-30/7	636	322.3	30x3.70	7x3.70	397.8	322.6	25.9	1481	892.8	588.2	138
Egret	322-A1/S1A-30/19	636	322.3	30x3.70	19x2.22	396.1	322.3	25.9	1470	892.8	577.1	141
Goose	322-A1/S1A-54/7	636	322.3	54x2.76	7x2.76	365.0	322.3	24.8	1225	897.5	327.3	104
Flamingo	337-A1/S1A-24/7	666.6	337.8	24x4.23	7x2.82	381.0	337.3	25.4	1273	931.5	341.7	105
Gannet	338-A1/S1A-26/7	666.6	337.8	26x4.07	7x3.16	393.2	338.3	25.8	1364	934.9	429.1	116
-none-	338-A1/S1A-42/7	666.6	337.8	42x3.20	7x1.78	355.2	337.8	24.5	1073	936.6	136.1	77.8
Gull	338-A1/S1A-54/7	666.6	337.8	54x2.82	7x2.82	381.0	337.8	25.4	1279	936.9	341.7	109
Stilt	363-A1/S1A-24/7	715.5	362.5	24x4.39	7x2.92	410.1	363.3	26.3	1370	1003	366.4	113
Starling	363-A1/S1A-26/7	715.5	362.5	26x4.21	7x3.28	421.1	362.6	26.7	1463	1000	462.3	125
Redwing	363-A1/S1A-30/19	715.5	362.5	30x3.92	19x2.35	444.5	362.6	27.4	1649	1002	646.6	154
-none-	363-A1/S1A-42/19	715.5	362.5	42x3.32	7x1.84	382.2	363.6	25.4	1154	1008	145.5	83.6
Crow	363-A1/S1A-54/7	715.5	362.5	54x2.92	7x2.92	408.5	362.6	26.3	1371	1005	366.4	117
Macaw	403-A1/S1A-42/7	795	402.8	42x3.49	7x1.94	422.5	402.8	26.8	1276	1114	161.7	92.5
Tern	404-A1/S1A-45/7	795	402.8	45x3.38	7x2.25	431.6	403.8	27.0	1338	1120	217.5	101
Puffin	403-A1/S1A-22/7	795	402.8	22x4.83	7x2.68	442.6	403.1	27.4	1421	1112	308.6	112
Cuckoo	402-A1/S1A-24/7	795	402.8	24x4.62	7x3.08	454.5	402.3	27.7	1519	1111	407.6	124
Condor	403-A1/S1A-54/7	795	402.8	54x3.08	7x3.08	454.5	402.8	27.7	1525	1118	407.6	126
Drake	403-A1/S1A-26/7	795	402.8	26x4.44	7x3.45	468.0	402.8	28.1	1624	1113	511.4	138
Mallard	403-A1/S1A-30/19	795	402.8	30x4.13	19x2.48	493.7	402.8	28.9	1832	1112	720.1	171
-none-	443-A1/S1A-42/7	874.5	443.1	42x3.67	7x2.04	467.2	443.1	28.1	1411	1232	178.8	102
Crane	443-A1/S1A-54/7	874.5	443.1	54x3.23	7x3.23	499.8	443.1	29.1	1677	1229	448.3	138
-none-	456-A1/S1A-42/7	900	456.0	42x3.72	7x2.07	480.0	456.5	28.5	1450	1266	184.1	105
Ruddy	456-A1/S1A-45/7	900	456.0	45x3.59	7x2.40	487.2	455.5	28.7	1511	1264	247.5	114
Canary	456-A1/S1A-54/7	900	456.0	54x3.28	7x3.28	515.4	456.0	29.5	1730	1268	462.3	143
Phoenix	483-A1/S1A-42/7	954	483.4	42x3.83	7x2.13	508.8	483.4	29.4	1537	1342	194.9	109
Rail	484-A1/S1A-45/7	955	483.8	45x3.70	7x2.47	517.4	483.8	29.6	1604	1342	262.1	120
Towhee	483-A1/S1A-48/7	953.5	483.2	48x3.58	7x2.79	526.0	483.2	29.9	1675	1341	334.5	131
Redbird	483-A1/S1A-24/7	952.5	482.6	24x5.06	7x3.38	545.4	482.6	30.4	1824	1333	490.9	149
Cardinal	483-A1/S1A-54/7	954	483.4	54x3.38	7x3.38	547.3	483.4	30.4	1837	1346	490.9	151
Snowbird	524-A1/S1A-42/7	1033.5	523.7	42x3.98	7x2.21	549.4	523.7	30.5	1659	1449	209.9	118
Ortolan	524-A1/S1A-45/7	1034	523.9	45x3.85	7x2.57	560.2	523.9	30.8	1737	1453	283.8	128
Whooper	525-A1/S1A-48/7	1035	524.5	48x3.73	7x2.90	570.7	524.5	31.1	1817	1456	361.4	142
Curlew	524-A1/S1A-54/7	1033.5	523.7	54x3.51	7x3.51	590.2	523.7	31.6	1981	1452	529.4	163
Beaumont (Avocet)	564-A1/S1A-42/7	1113	564.0	42x4.13	7x2.30	591.7	564.0	31.7	1787	1560	227.3	126
Bullfinch	564-A1/S1A-48/7	1113	564.0	48x3.87	7x3.01	614.4	564.0	32.3	1956	1567	389.3	150
Finch	564-A1/S1A-54/19	1113	564.0	54x3.65	19x2.19	636.6	564.0	32.9	2131	1570	561.6	180

(1) Code words shown denote ACSR with regular-strength Class A galvanized steel core (S1A). See the Options section to find the appropriate code word modifier designation for alternative design options.

(2) Due to rounding, total values may be slightly greater or slightly less than the sum of the component values.

Dimensions and weights not designated minimum or maximum are nominal values and subject to manufacturing tolerances. In this context, weight means mass.

TransPowr® ACSR Bare Overhead Conductor

Aluminum Conductor Steel-Reinforced Concentric-Lay-Stranded

ACSR, ALUMINUM CONDUCTOR, STEEL REINFORCED, CONCENTRIC-LAY-STRANDED (ELECTRICAL PROPERTIES)

CODE WORD	CONDUCTOR SIZE		PERCENT BY MASS		RESISTANCE (3)OHMS/KM			AMPACITY @75°C (4)		GEOMETRIC MEAN RADIUS CM	INDUCTIVE REACTANCE OHM/KM (5)	CAPACITIVE REACTANCE MEGAOHM-KM (5)
	AWG or kcmil	mm ²	AL	STEEL	DC @20°C	AC @25°C	AC @75°C	STANDARD	E3X®			
Kingbird	636	322.3	86.46%	13.57%	0.08928	0.09213	0.1100	703	808	0.927	0.2635	0.1547
Goldfinch	636	322.3	78.27%	21.77%	0.08951	0.09216	0.1101	707	814	0.972	0.2599	0.1535
Rook	636	322.3	73.13%	26.83%	0.08953	0.09210	0.1101	709	818	0.997	0.2579	0.1528
Grosbeak	636	322.3	68.42%	31.56%	0.08962	0.09211	0.1101	712	822	1.02	0.2559	0.1522
Scoter	636	322.3	60.28%	39.72%	0.08975	0.09211	0.1102	717	829	1.07	0.2526	0.1508
Egret	636	322.3	60.73%	39.26%	0.08975	0.09211	0.1102	717	829	1.07	0.2526	0.1508
Goose	636	322.3	73.27%	26.72%	0.09012	0.09269	0.1108	707	815	1.01	0.2572	0.1528
Flamingo	666.6	337.8	73.17%	26.84%	0.08539	0.08791	0.1050	731	844	1.02	0.2559	0.1517
Gannet	666.6	337.8	68.54%	31.46%	0.08552	0.08796	0.1051	733	847	1.05	0.2543	0.1511
-none-	666.6	337.8	87.29%	12.68%	0.08575	0.08854	0.1057	722	832	0.966	0.2602	0.1534
Gull	666.6	337.8	73.25%	26.72%	0.08595	0.08847	0.1057	728	841	1.03	0.2556	0.1518
Stilt	715.5	362.5	73.21%	26.74%	0.07956	0.08202	0.09795	763	883	1.06	0.2533	0.1500
Starling	715.5	362.5	68.35%	31.60%	0.07965	0.08202	0.09799	766	887	1.08	0.2517	0.1493
Redwing	715.5	362.5	60.76%	39.21%	0.07981	0.08204	0.09806	771	895	1.13	0.2480	0.1480
-none-	715.5	362.5	87.35%	12.61%	0.07970	0.08244	0.09835	755	872	1.00	0.2576	0.1517
Crow	715.5	362.5	73.30%	26.73%	0.08008	0.08254	0.09858	761	881	1.06	0.2530	0.1500
Macaw	795	402.8	87.30%	12.67%	0.07190	0.07461	0.08893	805	933	1.05	0.2536	0.1492
Tern	795	402.8	83.71%	16.26%	0.07198	0.07459	0.08894	807	935	1.07	0.2523	0.1488
Puffin	795	402.8	78.25%	21.72%	0.07158	0.07408	0.08837	812	942	1.09	0.2513	0.1482
Cuckoo	795	402.8	73.14%	26.83%	0.07164	0.07403	0.08835	815	946	1.12	0.2494	0.1475
Condor	795	402.8	73.31%	26.73%	0.07210	0.07449	0.08891	812	943	1.12	0.2490	0.1475
Drake	795	402.8	68.53%	31.49%	0.07166	0.07396	0.08830	818	950	1.14	0.2477	0.1469
Mallard	795	402.8	60.70%	39.31%	0.07178	0.07393	0.08831	824	959	1.19	0.2441	0.1455
-none-	874.5	443.1	87.31%	12.67%	0.06538	0.06807	0.08106	854	992	1.11	0.2497	0.1469
Crane	874.5	443.1	73.29%	26.73%	0.06547	0.06782	0.08087	862	1004	1.18	0.2454	0.1452
-none-	900	456.0	87.31%	12.70%	0.06343	0.06613	0.07871	870	1011	1.12	0.2487	0.1462
Ruddy	900	456.0	83.65%	16.38%	0.06358	0.06618	0.07881	871	1013	1.14	0.2477	0.1458
Canary	900	456.0	73.29%	26.72%	0.06365	0.06600	0.07868	877	1023	1.19	0.2441	0.1446
Phoenix	954	483.4	87.31%	12.68%	0.05995	0.06265	0.07452	900	1049	1.16	0.2467	0.1448
Rail	955	483.8	83.67%	16.34%	0.05989	0.06248	0.07436	903	1053	1.18	0.2454	0.1444
Towhee	953.5	483.2	80.06%	19.97%	0.05998	0.06248	0.07439	905	1056	1.19	0.2444	0.1440
Redbird	952.5	482.6	73.08%	26.91%	0.05968	0.06202	0.07389	912	1065	1.22	0.2428	0.1432
Cardinal	954	483.4	73.27%	26.72%	0.06007	0.06240	0.07435	909	1062	1.23	0.2418	0.1432
Snowbird	1033.5	523.7	87.34%	12.65%	0.05530	0.05803	0.06894	946	1105	1.20	0.2438	0.1429
Ortolan	1034	523.9	83.65%	16.34%	0.05539	0.05801	0.06895	947	1107	1.22	0.2425	0.1425
Whooper	1035	524.5	80.13%	19.89%	0.05541	0.05792	0.06889	950	1111	1.24	0.2415	0.1421
Curlew	1033.5	523.7	73.30%	26.72%	0.05547	0.05780	0.06881	955	1118	1.28	0.2392	0.1413
Beaumont (Avocet)	1113	564.0	87.30%	12.72%	0.05137	0.05413	0.06423	989	1158	1.25	0.2408	0.1411
Bullfinch	1113	564.0	80.11%	19.90%	0.05141	0.05395	0.06409	994	1166	1.29	0.2385	0.1404
Finch	1113	564.0	73.67%	26.35%	0.05145	0.05379	0.06397	1000	1174	1.33	0.2362	0.1395

(3) Based on a conductivity of 61.0% IACS at 20°C for aluminum. Per CSA C61089, the conductivity of the steel is not to be factored in. For the AWG sizes of ACSR, the approximated hysteresis losses in the steel are included.

(4) Based on a conductor temperature of 75°C at 60 Hz and the following conditions, 32°C ambient temperature, 1.98 ft/sec (0.6 m/sec) crosswind (90° to conductor), 0.5 coefficient of emissivity for a standard conductor and 0.9 for a E3X coated conductor, 0.5 coefficient of absorptivity for a standard conductor and 0.2 for a E3X coated conductor, 42° northern latitude, sea level elevation, 90° azimuth of line (East-West), clear atmosphere, and a date and time of noon on July 1 (resulting in 95.0 W/ft² of solar and sky radiated heat). Actual ampacity will differ based on local conditions. For specific ampacities, please contact your General Cable sales representative.

(5) Values for inductive reactance and capacitive reactance are expressed in terms of a 1 ft radius (30.48 cm).



TransPowr® ACSR Bare Overhead Conductor

Aluminum Conductor Steel-Reinforced Concentric-Lay-Stranded

ACSR, ALUMINUM CONDUCTOR, STEEL REINFORCED, CONCENTRIC-LAY-STRANDED (MECHANICAL PROPERTIES)

CODE WORD (1)	CSA DESIGNATION	CONDUCTOR SIZE		STRANDING NO. X DIA. (mm)		CROSS-SECTION (mm ²)		O.D. (mm)	NOMINAL MASS KG/KM (2)			RATED STRENGTH kN
		AWG or kcmil	mm ²	AL	STEEL	TOTAL	AL		TOTAL	AL	STEEL	
Oxbird	604-A1/S1A-42/7	1192.5	604.3	42x4.28	7x2.38	635.4	604.3	32.8	1919	1675	243.4	135
Bunting	606-A1/S1A-45/7	1195.5	605.8	45x4.14	7x2.76	647.6	605.8	33.1	2008	1680	327.3	148
Cormorant	603-A1/S1A-48/7	1190.5	603.2	48x4.00	7x3.11	656.4	603.2	33.3	2090	1674	415.6	158
Grackle	604-A1/S1A-54/19	1192.5	604.3	54x3.77	19x2.27	679.7	604.3	34.0	2278	1675	603.3	189
Scissortail	645-A1/S1A-42/7	1272	644.5	42x4.42	7x2.46	677.7	644.5	33.9	2047	1787	260.0	144
Bittern	644-A1/S1A-45/7	1272	644.5	45x4.27	7x2.85	689.1	644.4	34.2	2137	1788	349.0	157
Diver	646-A1/S1A-48/7	1272	644.5	48x4.14	7x3.22	703.2	646.2	34.5	2239	1793	445.5	169
Pheasant	645-A1/S1A-54/19	1272	644.5	54x3.90	19x2.34	726.8	644.5	35.1	2433	1792	641.1	200
Ringdove	685-A1/S1A-42/7	1351.5	684.8	42x4.56	7x2.53	721.1	685.9	35.0	2177	1902	275.0	153
Dipper	685-A1/S1A-45/7	1351.5	684.8	45x4.40	7x2.93	731.4	684.2	35.2	2267	1898	368.9	167
-none-	685-A1/S1A-48/7	1351.5	684.8	48x4.26	7x3.31	744.4	684.8	35.5	2370	1899	470.8	179
Martin	685-A1/S1A-54/19	1351.5	684.8	54x4.02	19x2.41	772.1	684.8	36.2	2584	1904	680.1	212
Popinjay	726-A1/S1A-42/7	1431	725.1	42x4.69	7x2.61	763.0	725.6	36.0	2305	2012	292.7	162
Bobolink	725-A1/S1A-45/7	1431	725.1	45x4.53	7x3.02	775.4	725.3	36.2	2404	2012	391.9	177
Wagtail	727-A1/S1A-48/7	1431	725.1	48x4.39	7x3.41	790.5	726.5	36.6	2516	2016	499.6	190
Plover	725-A1/S1A-54/19	1431	725.1	54x4.13	19x2.48	815.2	725.1	37.2	2730	2010	720.1	224
-none-	765-A1/S1A-42/7	1510.5	765.4	42x4.82	7x2.67	805.6	765.4	36.9	2431	2125	306.3	171
Nuthatch	765-A1/S1A-45/7	1510.5	765.4	45x4.65	7x3.10	817.0	764.2	37.2	2533	2120	412.9	184
Parrot	765-A1/S1A-54/19	1510.5	765.4	54x4.25	19x2.55	863.1	765.4	38.3	2889	2128	761.4	237
Ratite	806-A1/S1A-42/7	1590	805.7	42x4.94	7x2.75	846.6	805.7	37.9	2557	2232	324.9	180
Lapwing	806-A1/S1A-45/7	1590	805.7	45x4.77	7x3.18	859.7	805.7	38.2	2665	2231	434.5	194
Hornbill	806-A1/S1A-48/7	1590	805.7	48x4.62	7x3.60	875.9	805.7	38.5	2790	2233	556.9	211
Falcon	806-A1/S1A-54/19	1590	805.7	54x4.36	19x2.62	908.7	805.7	39.3	3043	2240	803.7	250
-none-	806-A1/S1A-72/7	1590	805.7	72x3.77	7x2.52	838.6	805.7	37.7	2511	2238	272.9	172
Chukar	902-A1/S1A-84/19	1780	901.9	84x3.70	19x2.22	974.8	901.9	46.4	3082	2505	577.1	239
Seahawk	947-A1/S1A-68/7	1869	947.0	68x4.21	7x2.34	976.7	947.0	40.7	2870	2635	235.3	191
Mockingbird	1031-A1/S1A-72/7	2034.5	1030.9	72x4.27	7x2.85	1076	1030.9	42.7	3220	2871	349.0	221
Roadrunner	1043-A1/S1A-76/19	2057.5	1042.6	76x4.18	19x1.95	1100	1042.6	43.2	3350	2905	445.2	238
Bluebird	1092-A1/S1A-84/19	2156	1092.5	84x4.07	19x2.44	1182	1092.5	44.8	3743	3046	697.1	282
Kiwi	1098-A1/S1A-72/7	2167	1098.0	72x4.41	7x2.94	1147	1098.0	44.1	3433	3062	371.4	236
Thrasher	1172-A1/S1A-76/19	2312	1171.5	76x4.43	19x2.07	1235	1171.5	45.8	3764	3263	501.7	268
Joree	1274-A1/S1A-76/19	2515	1274.4	76x4.62	19x2.16	1344	1274.4	47.8	4095	3549	546.3	292

(1) Code words shown denote ACSR with regular-strength Class A galvanized steel core (S1A). See the Options section to find the appropriate code word modifier designation for alternative design options.

(2) Due to rounding, total values may be slightly greater or slightly less than the sum of the component values.

Dimensions and weights not designated minimum or maximum are nominal values and subject to manufacturing tolerances. In this context, weight means mass.

TransPowr® ACSR Bare Overhead Conductor

Aluminum Conductor Steel-Reinforced Concentric-Lay-Stranded

ACSR, ALUMINUM CONDUCTOR, STEEL REINFORCED, CONCENTRIC-LAY-STRANDED (ELECTRICAL PROPERTIES)

CODE WORD	CONDUCTOR SIZE		PERCENT BY MASS		RESISTANCE (3)OHMS/KM			AMPACITY @75°C (4)		GEOMETRIC MEAN RADIUS CM	INDUCTIVE REACTANCE OHM/KM (5)	CAPACITIVE REACTANCE MEGAOHM-KM (5)
	AWG or kcmil	mm ²	AL	STEEL	DC @20°C	AC @25°C	AC @75°C	STANDARD	E3X®			
Oxbird	1192.5	604.3	87.29%	12.68%	0.04795	0.05076	0.06016	1031	1210	1.29	0.2382	0.1395
Bunting	1195.5	605.8	83.67%	16.30%	0.04797	0.05066	0.06007	1034	1214	1.31	0.2372	0.1391
Cormorant	1190.5	603.2	80.10%	19.89%	0.04801	0.05058	0.06002	1037	1218	1.33	0.2359	0.1387
Grackle	1192.5	604.3	73.53%	26.48%	0.04804	0.05040	0.05988	1043	1227	1.38	0.2336	0.1378
Scissortail	1272	644.5	87.30%	12.70%	0.04497	0.04783	0.05661	1072	1261	1.34	0.2356	0.1379
Bittern	1272	644.5	83.67%	16.33%	0.04499	0.04773	0.05652	1075	1265	1.36	0.2346	0.1376
Diver	1272	644.5	80.08%	19.90%	0.04499	0.04760	0.05642	1078	1270	1.38	0.2336	0.1372
Pheasant	1272	644.5	73.65%	26.35%	0.04502	0.04741	0.05627	1085	1279	1.42	0.2313	0.1363
Ringdove	1351.5	684.8	87.37%	12.63%	0.04230	0.04523	0.05345	1112	1310	1.38	0.2336	0.1365
Dipper	1351.5	684.8	83.72%	16.27%	0.04233	0.04512	0.05337	1115	1315	1.40	0.2323	0.1361
-none-	1351.5	684.8	80.13%	19.86%	0.04235	0.04501	0.05328	1118	1320	1.42	0.2313	0.1357
Martin	1351.5	684.8	73.68%	26.32%	0.04239	0.04481	0.05313	1125	1329	1.46	0.2290	0.1349
Popinjay	1431	725.1	87.29%	12.70%	0.03995	0.04295	0.05068	1150	1358	1.42	0.2313	0.1351
Bobolink	1431	725.1	83.69%	16.30%	0.03999	0.04284	0.05060	1154	1363	1.44	0.2303	0.1348
Wagtail	1431	725.1	80.13%	19.86%	0.03998	0.04269	0.05047	1158	1369	1.46	0.2290	0.1343
Plover	1431	725.1	73.63%	26.38%	0.04003	0.04249	0.05032	1165	1379	1.51	0.2267	0.1335
-none-	1510.5	765.4	87.41%	12.60%	0.03787	0.04094	0.04823	1187	1404	1.45	0.2293	0.1339
Nuthatch	1510.5	765.4	83.70%	16.30%	0.03788	0.04079	0.04811	1191	1410	1.48	0.2280	0.1335
Parrot	1510.5	765.4	73.66%	26.36%	0.03790	0.04041	0.04779	1204	1427	1.55	0.2247	0.1322
Ratite	1590	805.7	87.29%	12.71%	0.03595	0.03909	0.04598	1224	1451	1.49	0.2274	0.1326
Lapwing	1590	805.7	83.71%	16.30%	0.03597	0.03895	0.04587	1228	1456	1.51	0.2264	0.1322
Hornbill	1590	805.7	80.04%	19.96%	0.03600	0.03883	0.04577	1232	1462	1.54	0.2251	0.1319
Falcon	1590	805.7	73.61%	26.41%	0.03603	0.03858	0.04557	1241	1474	1.59	0.2228	0.1310
-none-	1590	805.7	89.13%	10.87%	0.03611	0.03932	0.04624	1220	1445	1.49	0.2277	0.1328
Chukar	1780	901.9	81.28%	18.72%	0.04584	0.04847	0.05746	1115	1329	1.61	0.2218	0.1292
Seahawk	1869	947.0	91.81%	8.20%	0.03071	0.03432	0.04009	1336	1591	1.60	0.2225	0.1292
Mockingbird	2034.5	1030.9	89.16%	10.84%	0.02822	0.03187	0.03712	1405	1679	1.69	0.2182	0.1269
Roadrunner	2057.5	1042.6	86.72%	13.29%	0.02793	0.03145	0.03666	1418	1696	1.71	0.2172	0.1264
Bluebird	2156	1092.5	81.38%	18.62%	0.02666	0.02999	0.03497	1466	1758	1.79	0.2136	0.1247
Kiwi	2167	1098.0	89.19%	10.82%	0.02649	0.03027	0.03516	1456	1744	1.74	0.2159	0.1254
Thrasher	2312	1171.5	86.69%	13.33%	0.02485	0.02862	0.03317	1514	1818	1.81	0.2126	0.1236
Joree	2515	1274.4	86.67%	13.34%	0.02284	0.02680	0.03093	1585	1910	1.89	0.2097	0.1216

(3) Based on a conductivity of 61.0% IACS at 20°C for aluminum. Per CSA C61089, the conductivity of the steel is not to be factored in. For the AWG sizes of ACSR, the approximated hysteresis losses in the steel are included.

(4) Based on a conductor temperature of 75°C at 60 Hz and the following conditions, 32°C ambient temperature, 1.98 ft/sec (0.6 m/sec) crosswind (90° to conductor), 0.5 coefficient of emissivity for a standard conductor and 0.9 for a E3X coated conductor, 0.5 coefficient of absorptivity for a standard conductor and 0.2 for a E3X coated conductor, 42° northern latitude, sea level elevation, 90° azimuth of line (East-West), clear atmosphere, and a date and time of noon on July 1 (resulting in 95.0 W/ft² of solar and sky radiated heat). Actual ampacity will differ based on local conditions. For specific ampacities, please contact your General Cable sales representative.

(5) Values for inductive reactance and capacitive reactance are expressed in terms of a 1 ft radius (30.48 cm).



TransPowr® ACSR Bare Overhead Conductor

Aluminum Conductor Steel-Reinforced Concentric-Lay-Stranded

ACSR, ALUMINUM CONDUCTOR, STEEL REINFORCED, CONCENTRIC-LAY-STRANDED HIGH-STRENGTH STRANDING (MECHANICAL PROPERTIES)

CODE WORD (1)	CSA DESIGNATION	CONDUCTOR SIZE		STRANDING NO. X DIA. (mm)		CROSS-SECTION SQ (mm ²)		O.D. (mm)	NOMINAL MASS KG/KM (2)			RATED STRENGTH kN
		kcmil	mm ²	AL	STEEL	TOTAL	AL		TOTAL	AL	STEEL	
Grouse	41-A1/S1A-8/1	80.0	40.5	8x2.54	1x4.24	54.7	40.5	9.32	221.5	111.6	109.9	22.8
Petrel	52-A1/S1A-12/7	101.8	51.6	12x2.34	7x2.34	81.7	51.6	11.7	377.9	142.6	235.3	43.9
Minorca	56-A1/S1A-12/7	110.7	56.1	12x2.44	7x2.44	88.8	56.1	12.2	410.9	155.1	255.8	47.7
Leghorn	68-A1/S1A-12/7	134.6	68.2	12x2.69	7x2.69	108.0	68.2	13.5	499.4	188.5	310.9	57.6
Guinea	81-A1/S1A-12/7	159.0	80.6	12x2.92	7x2.92	127.2	80.6	14.6	588.4	222.1	366.4	67.5
Dotterel	90-A1/S1A-12/7	176.8	89.6	12x3.08	7x3.08	141.6	89.6	15.4	654.7	247.1	407.6	72.6
Dorking	97-A1/S1A-12/7	190.8	96.7	12x3.20	7x3.20	152.8	96.7	16.0	706.7	266.7	440.0	78.3
Auk	103-A1/S1A-8/7	203.1	102.9	8x4.05	7x2.25	130.9	102.9	14.9	501.3	283.8	217.5	49.6
Brahma	103-A1/S1A-16/19	203.3	103.0	16x2.86	19x2.48	194.6	103.0	18.1	1005	285.3	720.1	123
Cochin	107-A1/S1A-12/7	211.4	107.1	12x3.37	7x3.37	169.5	107.1	16.9	783.8	295.8	488.0	86.9

ACSR, ALUMINUM CONDUCTOR, STEEL REINFORCED, CONCENTRIC-LAY-STRANDED CANADIAN DIAMETER-BASED SIZES (MECHANICAL PROPERTIES)

CODE WORD (1)	CSA DESIGNATION	CONDUCTOR SIZE		STRANDING NO. X DIA. (mm)		CROSS-SECTION SQ (mm ²)		O.D. (mm)	NOMINAL MASS KG/KM (2)			RATED STRENGTH kN
		kcmil	mm ²	AL	STEEL	TOTAL	AL		TOTAL	AL	STEEL	
Shelter Bay	255-A1/S1A-22/7	504.0	255.5	22x3.85	7x2.14	281.3	255.5	21.8	903.6	706.8	196.8	71.7
Chignecto	298-A1/S1A-22/7	589.0	298.4	22x4.16	7x2.31	328.4	298.4	23.6	1054	825.2	229.3	82.8
Peace River	317-A1/S1A-48/7	625.5	317.0	48x2.90	7x2.25	344.9	317.0	24.2	1097	879.9	217.5	88.0
Mica	338-A1/S1A-24/7	667.0	337.9	24x4.23	7x2.82	381.0	337.9	25.4	1273	931.5	341.7	105
Grand Rapid	347-A1/S1A-22/7	684.5	346.8	22x4.48	7x2.49	380.9	346.8	25.4	1223	957.0	266.4	96.1
Chute Des Passes	430-A1/S1A-45/7	849.5	430.5	45x3.49	7x2.33	460.3	430.5	27.9	1427	1194	233.3	107
Les Boules	440-A1/S1A-42/7	867.5	439.5	42x3.65	7x2.02	461.9	439.5	28.0	1394	1219	175.3	101
Carillon	523-A1/S1A-42/7	1031.0	522.5	42x3.98	7x2.21	549.4	522.5	30.5	1659	1449	209.9	118
Gatineau	591-A1/S1A-48/7	1166.5	591.2	48x3.96	7x3.08	643.3	591.2	33.0	2048	1641	407.6	155
Seaway	647-A1/S1A-42/7	1277.5	647.4	42x4.43	7x2.46	680.6	647.4	34.0	2055	1795	260.0	145
Bersfort	687-A1/S1A-48/7	1356.5	687.4	48x4.27	7x3.32	748.0	687.4	35.6	2381	1908	473.6	180
Bersimis	689-A1/S1A-42/7	1359.5	688.9	42x4.57	7x2.54	724.4	688.9	35.0	2187	1910	277.2	154
Nelson	932-A1/S1A-72/7	1839.5	932.1	72x4.06	7x2.71	972.5	932.1	40.6	2911	2595	315.6	200

(1) Code words shown denote ACSR with regular-strength Class A galvanized steel core (S1A). See the Options section to find the appropriate code word modifier designation for alternative design options.

(2) Due to rounding, total values may be slightly greater or slightly less than the sum of the component values.

Dimensions and weights not designated minimum or maximum are nominal values and subject to manufacturing tolerances. In this context, weight means mass.

TransPowr® ACSR Bare Overhead Conductor

Aluminum Conductor Steel-Reinforced Concentric-Lay-Stranded

ACSR, ALUMINUM CONDUCTOR, STEEL REINFORCED, CONCENTRIC-LAY-STRANDED HIGH-STRENGTH STRANDING (ELECTRICAL PROPERTIES)

CODE WORD (1)	CONDUCTOR SIZE		PERCENT BY MASS		RESISTANCE (3)OHMS/KM			AMPACITY @75°C (4)		GEOMETRIC MEAN RADIUS CM	INDUCTIVE REACTANCE OHM/KM (5)	CAPACITIVE REACTANCE MEGAOHM/KM (5)
	kcmil	mm ²	AL	STEEL	DC @20°C	AC @25°C	AC @75°C	STANDARD	E3X®			
Grouse	80	40.54	50.38%	49.62%	0.7098	0.7242	0.979	186	204	0.137	0.407	0.1996
Petrel	101.8	51.58	37.73%	62.27%	0.5599	0.5713	0.893	219	241	0.174	0.383	0.1888
Minorca	110.7	56.1	37.75%	62.25%	0.5143	0.5247	0.736	229	253	0.199	0.379	0.1867
Leghorn	134.6	68.2	37.75%	62.25%	0.4235	0.4321	0.619	256	284	0.230	0.369	0.1821
Guinea	159.0	80.6	37.75%	62.27%	0.3585	0.3658	0.536	281	313	0.244	0.360	0.1781
Dotterel	176.8	89.6	37.74%	62.26%	0.3223	0.3288	0.489	299	333	0.279	0.354	0.1756
Dorking	190.8	96.7	37.74%	62.26%	0.2987	0.3048	0.458	312	348	0.295	0.350	0.1738
Auk	203.1	102.9	56.61%	43.39%	0.2797	0.2855	0.414	321	360	0.315	0.345	0.1774
Brahma	203.3	103.0	28.39%	71.65%	0.2817	0.2874	0.431	332	371	0.343	0.338	0.1678
Cochin	211.4	107.1	37.74%	62.26%	0.2697	0.2752	0.419	330	369	0.318	0.344	0.1713

ACSR, ALUMINUM CONDUCTOR, STEEL REINFORCED, CONCENTRIC-LAY-STRANDED CANADIAN DIAMETER-BASED SIZES (ELECTRICAL PROPERTIES)

CODE WORD (1)	CONDUCTOR SIZE		PERCENT BY MASS		RESISTANCE (3)OHMS/KM			AMPACITY @75°C (4)		GEOMETRIC MEAN RADIUS CM	INDUCTIVE REACTANCE OHM/KM (5)	CAPACITIVE REACTANCE MEGAOHM/KM (5)
	kcmil	mm ²	AL	STEEL	DC @20°C	AC @25°C	AC @75°C	STANDARD	E3X®			
Shelter Bay	504.0	255.5	78.22%	21.78%	0.1129	0.1158	0.1385	612	700	0.866	0.2684	0.1590
Chignecto	589.0	298.4	78.29%	21.76%	0.09665	0.09938	0.1188	674	775	0.936	0.2628	0.1553
Peace River	625.5	317.0	80.21%	19.83%	0.09143	0.09413	0.1125	697	802	0.966	0.2602	0.1541
Mica	667.0	337.9	73.17%	26.84%	0.08539	0.08791	0.1050	731	844	1.02	0.2559	0.1517
Grand Rapid	684.5	346.8	78.25%	21.78%	0.08313	0.08572	0.1024	740	854	1.01	0.2569	0.1518
Chute Des Passes	849.5	430.5	83.67%	16.35%	0.06734	0.06994	0.08334	840	976	1.11	0.2497	0.1472
Les Boules	867.5	439.5	87.45%	12.58%	0.06593	0.06862	0.08172	849	986	1.10	0.2503	0.1472
Carillon	1031.0	522.5	87.34%	12.65%	0.05544	0.05817	0.06911	944	1103	1.20	0.2438	0.1430
Gatineau	1166.5	591.2	80.13%	19.90%	0.04906	0.05162	0.06128	1023	1201	1.32	0.2369	0.1392
Seaway	1277.5	647.4	87.35%	12.65%	0.04476	0.04763	0.05637	1075	1264	1.34	0.2356	0.1379
Bersfort	1356.5	687.4	80.13%	19.89%	0.04220	0.04486	0.05310	1121	1322	1.42	0.2313	0.1356
Bersimis	1359.5	688.9	87.33%	12.67%	0.04207	0.04500	0.05317	1116	1315	1.38	0.2333	0.1364
Nelson	1839.5	932.1	89.14%	10.84%	0.03123	0.03468	0.04057	1327	1580	1.60	0.2221	0.1293

(4) Based on a conductivity of 61.0% IACS at 20°C for aluminum. Per CSA C61089, the conductivity of the steel is not to be factored in. For the Single Layer ACSR sizes, the approximated hysteresis losses in the steel are included.
 (5) Based on a conductor temperature of 75°C at 60 Hz and the following conditions, 32°C ambient temperature, 1.98 ft/sec (0.6 m/sec) crosswind (90° to conductor), 0.5 coefficient of emissivity for a standard conductor and 0.9 for a E3X coated conductor, 0.5 coefficient of absorptivity for a standard conductor and 0.2 for a E3X coated conductor, 42° northern latitude, sea level elevation, 90° azimuth of line (East-West), clear atmosphere, and a date and time of noon on July 1 (resulting in 95.0 W/ft² of solar and sky radiated heat). Actual ampacity will differ based on local conditions. For specific ampacities, please contact your General Cable sales representative.
 (5) Values for inductive reactance and capacitive reactance are expressed in terms of a 1 ft radius (30.48 cm).



Notes



TransPowr[®] Compact (Smooth Body) ACSR Bare Overhead Conductor

Aluminum Conductor Steel-Reinforced Compact Stranded

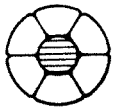

Type 100

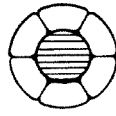

Type 150

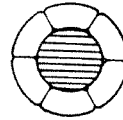

Type 200

Product Construction:

Complete Conductor:

Smooth Body ACSR is a composite compact-lay-stranded conductor. The conductors are manufactured in accordance with the requirements of the latest applicable issues of CSA C49.2.

The steel strands form the central core of the conductor, around which is stranded a layer of aluminum 1350-H19 wires. The sizes listed on the following pages are common examples used in overhead lines. Metric (mm²) sizes are also available.

The Canadian Smooth Body ACSR conductors are supplied in various tensile strength configurations, designated as Type 100, Type 150, and Type 200. For each conductor gauge size, the regular product is known as Type 100. Type 150 designates a conductor design with the same AWG size, but with 150% the rated strength of the Type 100. Type 200 follows accordingly, with twice the rated strength of the Type 100.

Features and Benefits:

ACSR conductors are recognized for their record of economy, dependability and favorable strength/weight ratio. ACSR conductors combine the light weight and good conductivity of aluminum with the high tensile strength and ruggedness of steel. In line design, this can provide higher tensions, less sag, and longer span lengths than obtainable with most other types of overhead conductors. The steel strands are added as mechanical reinforcements. The cross-sections above illustrate some common strandings.

The steel core wires are protected from corrosion by galvanizing. The standard Class A zinc coating is usually adequate for ordinary environments. For greater protection, Class B and C galvanized coatings may be specified.

The product is available with conductor corrosion-resistant inhibitor treatment applied to the central steel component.

Applications:

Compact Aluminum Conductors, Steel-Reinforced (ACSR) are used for overhead distribution and transmission lines.

The Type 100 compact ACSR conductor style is also used as the support conductor in the CSA Neutral Supported Service Entrance Cable as referenced in the CSA C22.2 No. 129 specification.

Options:

- High-Conductivity aluminum (/HC) (62.2% IACS)
- CSA high-strength Class A galvanized steel core (S2A)
- CSA extra-high-strength Class A galvanized steel core (S3A)
- ASTM regular-strength Class A zinc-5% aluminum mischmetal alloy-coated steel core (/MA2 to ASTM B802)
- ASTM high-strength Class A zinc-5% aluminum mischmetal alloy-coated steel core (/MA3 to ASTM B803)
- Aluminum-clad steel core (20SA)
- Regular-strength Class C galvanized steel core (S1C)
- Non-Specular surface finish (/NS)
- CSA C68.8 for distribution utilities
- E3X[®] surface coating (/E3X)

For more information, contact your General Cable sales representative or e-mail info@generalcable.com.



TransPowr® Compact (Smooth Body) ACSR Bare Overhead Conductor

Aluminum Conductor Steel-Reinforced Compact Stranded

ACSR, ALUMINUM CONDUCTOR, STEEL REINFORCED, COMPACT-LAY-STRANDED (MECHANICAL PROPERTIES)

CODE WORD (1)	CSA DESIGNATION	CONDUCTOR SIZE		STRANDING NO. X DIA. (mm)		CROSS-SECTION (mm ²)		O.D. (mm)	NOMINAL MASS KG/KM (2)			RATED STRENGTH kN	CONDUCTOR TYPE (3)
		AWG	mm ²	AL	STEEL	TOTAL	AL		TOTAL	AL	STEEL		
Bass	13-A1F/S1A-6/1-46	#6	13.3	6	1x1.68	15.50	13.3	4.62	53.67	36.43	17.25	5.19	100
Mullet	13-A1F/S1A-6/1-49	#6	13.3	6	1x2.38	17.70	13.3	4.90	71.12	36.51	34.61	7.67	150
Herring	13-A1F/S1A-6/1-53	#6	13.3	6	1x3.00	20.40	13.3	5.28	91.56	36.57	54.99	10.7	200
Pike	21-A1F/S1A-6/1-58	#4	21.2	6	1x2.12	24.70	21.2	5.82	85.47	58.01	27.46	8.15	100
Pollock	21-A1F/S1A-6/1-62	#4	21.2	6	1x3.00	28.20	21.2	6.17	113.1	58.14	54.99	12.1	150
Flounder	21-A1F/S1A-6/1-67	#4	21.2	6	1x3.78	32.40	21.2	6.71	145.5	58.23	87.31	16.4	200
Carp	34-A1F/S1A-6/1-74	#2	33.6	6	1x2.67	39.20	33.6	7.37	135.6	92.01	43.56	12.4	100
Haddock	34-A1F/S1A-6/1-78	#2	33.6	6	1x3.78	44.80	33.6	7.82	179.5	92.22	87.31	18.4	150
Pickrel	34-A1F/S1A-6/1-84	#2	33.6	6	1x4.77	51.50	33.6	8.41	231.4	92.37	139.0	25.7	200
Shad	42-A1F/S1A-6/1-83	#1	42.4	6	1x3.00	49.50	42.4	8.28	171.1	116.2	54.99	15.5	100
Lamprey	42-A1F/S1A-6/1-88	#1	42.4	6	1x4.25	56.60	42.4	8.79	226.8	116.4	110.4	23.0	150
Sole	54-A1F/S1A-6/1-93	1/0	53.5	6	1x3.37	62.40	53.5	9.27	216.0	146.6	69.40	18.9	100
Sculpin	54-A1F/S1A-6/1-99	1/0	53.5	6	1x4.77	71.40	53.5	9.86	285.9	146.9	139.0	28.8	150
Hake	67-A1F/S1A-6/1-104	2/0	67.4	6	1x3.78	78.60	67.4	10.4	271.7	184.4	87.31	23.5	100
Cusk	85-A1F/S1A-6/1-117	3/0	85.0	6	1x4.25	99.30	85.0	11.7	343.5	233.1	110.4	29.6	100
Scup	107-A1F/S1A-6/1-131	4/0	107.2	6	1x4.77	125.1	107.2	13.1	432.7	293.7	139.0	37.3	100

(1) Code words shown denote ACSR with regular-strength Class A galvanized steel core (S1A). See the Options section to find the appropriate code word modifier designation for alternative design options.

(2) Due to rounding, total values may be slightly greater or slightly less than the sum of the component values.

(3) A Type 150 construction has 150% of the rated strength of a Type 100 construction, and a Type 200 has 200% of the rated strength of a Type 100 construction.

Dimensions and weights not designated minimum or maximum are nominal values and subject to manufacturing tolerances. In this context, weight means mass.

TransPowr[®] Compact (Smooth Body) ACSR Bare Overhead Conductor

Aluminum Conductor Steel-Reinforced Compact Stranded

ACSR, ALUMINUM CONDUCTOR, STEEL REINFORCED, COMPACT-LAY-STRANDED (ELECTRICAL PROPERTIES)

CODE WORD (1)	CONDUCTOR SIZE		PERCENT BY MASS		RESISTANCE (4)OHMS/KM			AMPACITY @75°C (5)		GEOMETRIC MEAN RADIUS CM	INDUCTIVE REACTANCE OHM/KM (6)	CAPACITIVE REACTANCE MEGAOHM/KM (6)
	AWG	mm ²	AL	STEEL	DC @20°C	AC @25°C	AC @75°C	STANDARD	E3X [®]			
Bass	#6	13.3	67.88%	32.14%	2.154	2.198	2.77	93	99	0.052	0.476	0.2331
Mullet	#6	13.3	51.34%	48.66%	2.159	2.203	2.82	93	100	0.051	0.482	0.1857
Herring	#6	13.3	39.94%	60.06%	2.163	2.207	2.84	95	101	0.054	0.478	0.2267
Pike	#4	21.2	67.87%	32.13%	1.350	1.377	1.77	123	132	0.079	0.449	0.2221
Pollock	#4	21.2	51.41%	48.62%	1.353	1.381	1.82	123	132	0.082	0.446	0.2193
Flounder	#4	21.2	40.02%	60.01%	1.355	1.383	1.84	125	135	0.087	0.442	0.2153
Carp	#2	33.6	67.85%	32.12%	0.8522	0.8695	1.14	162	176	0.122	0.416	0.2108
Haddock	#2	33.6	51.38%	48.64%	0.8541	0.8714	1.18	162	176	0.128	0.412	0.2080
Pickarel	#2	33.6	39.92%	60.07%	0.8555	0.8729	1.20	163	178	0.125	0.414	0.2045
Shad	#1	42.4	67.91%	32.14%	0.6749	0.6886	0.916	186	204	0.151	0.400	0.2052
Lamprey	#1	42.4	51.32%	48.68%	0.6764	0.6902	0.951	186	203	0.156	0.398	0.2024
Sole	1/0	53.5	67.87%	32.13%	0.5346	0.5455	0.738	213	235	0.183	0.386	0.1999
Sculpin	1/0	53.5	51.38%	48.62%	0.5358	0.5467	0.770	212	234	0.189	0.383	0.1969
Hake	2/0	67.4	67.87%	32.13%	0.4251	0.4339	0.595	245	270	0.216	0.373	0.1943
Cusk	3/0	85.0	67.86%	32.14%	0.3363	0.3433	0.482	280	311	0.256	0.360	0.1887
Scup	4/0	107.2	67.88%	32.12%	0.2669	0.2725	0.391	320	358	0.303	0.348	0.1832

(4) Based on a conductivity of 61.0% IACS at 20°C for aluminum. Per CSA C61089, the conductivity of the steel is not to be factored in. For the AWG sizes of these ACSR, the approximated hysteresis losses in the steel are included.

(5) Based on a conductor temperature of 75°C at 60 Hz and the following conditions, 32°C ambient temperature, 1.98 ft/sec (0.6 m/sec) crosswind (90° to conductor), 0.5 coefficient of emissivity for a standard conductor and 0.9 for a E3X coated conductor, 0.5 coefficient of absorptivity for a standard conductor and 0.2 for a E3X coated conductor, 42° northern latitude, sea level elevation, 90° azimuth of line (East-West), clear atmosphere, and a date and time of noon on July 1 (resulting in 95.0 W/ft² of solar and sky radiated heat). Actual ampacity will differ based on local conditions. For specific ampacities, please contact your General Cable sales representative.

(6) Values for inductive reactance and capacitive reactance are expressed in terms of a 1 ft radius (30.48 cm).



Notes



TransPowr[®] ACSR/TW Bare Overhead Conductor

Trapezoidal Aluminum Conductor Steel-Reinforced Concentric-Lay-Stranded

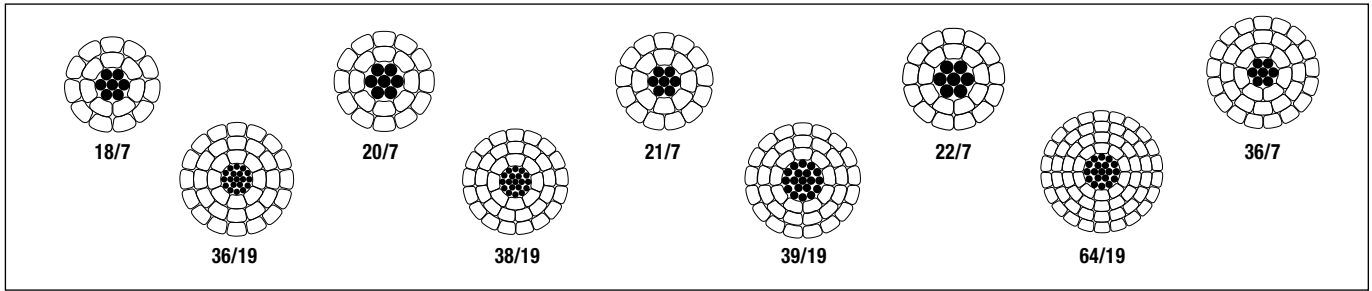

Product Construction:

Complete Conductor:

TransPowr[®] ACSR/TW is a trapezoidal aluminum conductor steel-reinforced concentric-lay-stranded conductor. The aluminum strands are trapezoidal in shape.

The wedge-shaped aluminum strands enable a more compact alignment of the aluminum wires. Conductor designs that maintain the same circular mil cross-sectional area of aluminum as a conventional round conductor result in a TW conductor that is 10 to 15 percent smaller in overall diameter. Conductor designs that maintain the same overall diameter as a conventional round conductor result in a TW conductor that has 20 to 25 percent more aluminum cross-sectional area packed in.

The ACSR/TW conductors are manufactured in accordance with the requirements of the latest issue of ASTM B779.

The steel strands form the central core of the conductor, around which is stranded two, three or four layers of aluminum 1350-H19 wires. The steel core may consist of a concentric stranded cable of 7, 19 or more wires. Numerous combinations of aluminum and steel strands and layers are possible. The sizes and constructions listed on the following pages are common examples used in overhead lines.

For ACSR/TW conductors, the standard Class A galvanized coating is usually adequate for ordinary environments.

Features and Benefits:

TransPowr[®] ACSR/TW has a continuous operating temperature rating of 75°C. ACSR and ACSR/TW conductors have an "industry-accepted" short-duration maximum operating temperature rating of 100°C. Operation of the conductor at elevated temperatures may increase the conductor sag properties and lower the rated tensile strength of the conductor.

TransPowr[®] ACSR/TW conductors are recognized for their record of economy, dependability and favorable strength-to-weight ratio. ACSR/TW conductors constructed of equivalent aluminum circular mil cross-sectional area provide a conductor that is smaller in overall diameter than the equivalent conventional round wire ACSR conductor. The reduced conductor diameter is advantageous in reducing the effects of ice and wind loading on the conductor. ACSR/TW conductors constructed to equivalent overall diameter enable a greater circular mil cross-sectional area of aluminum within the conductor, allowing a significant increase in conductor current-carrying capacity.

Applications:

Trapezoidal Aluminum Conductors Steel-Reinforced (ACSR/TW) are used for overhead transmission lines.

Electrical Parameters:

The electrical parameters for the trapezoidal ACSR equivalent circular mil area and equivalent overall diameter conductors may be found in the last table of this section.

Options:

- High-Conductivity aluminum (/HC) (62.2% IACS)
- Regular-strength Class C galvanized steel core (/GC2)
- High-strength Class A galvanized steel core (/GA3)
- Extra-high-strength Class A galvanized steel core (/GA4)
- Ultra-high-strength Class A galvanized steel core (/GA5)
- Regular-strength Class A zinc-5% aluminum mischmetal alloy-coated steel core (/MA2)
- High-strength Class A zinc-5% aluminum mischmetal alloy-coated steel core (/MA3)
- Extra-high-strength Class A zinc-5% aluminum mischmetal alloy-coated steel core (/MA4)
- Ultra-high-strength Class A zinc-5% aluminum mischmetal alloy-coated steel core (/MA5)
- Aluminum-clad steel core (/AW)
- Non-Specular surface finish (/NS)
- E3X[®] surface coating (/E3X)

At the present time, CAN/CSA C61089 does not recognize TW conductor designs. The information provided on the following pages is from our US catalog.

For other conductor sizes, designs and/or specific installation requirements not shown in the tables, contact your General Cable sales representative or e-mail infoca@generalcable.com.

TransPowr® ACSR/TW Bare Overhead Conductor

Trapezoidal Aluminum Conductor Steel-Reinforced Concentric-Lay-Stranded

ACSR/TW (MECHANICAL PROPERTIES) – REDUCED DIAMETER - CONDUCTORS SIZED TO HAVE EQUIVALENT CIRCULAR MIL AREA TO REGULAR ACSR

CODE WORD (1)	SIZE AWG OR kcmil	TYPE	NO. AL WIRES	FILL FACTOR	EQUIVALENT AL DIA. INCHES	STEEL CORE NO. X DIA. INCHES	STEEL CORE O.D. INCHES	CROSS-SECTION SQ. INCHES			APPROX. WEIGHT LB/1000 FT (2)			PERCENT BY MASS		RATED STRENGTH LBS			STANDARD PACKAGES (3)		
								TOTAL	AL	O.D. INCHES	TOTAL	AL	STEEL	AL	STEEL	GA2	GA3 (HS)	GA5 (UHS)	REEL DESIGNATION	WEIGHT LBS	LENGTH FEET
Oriole/ACSR/TW	336.4	23	17	88.7	0.1407	7x0.1059	0.3177	0.3258	0.2642	0.69	526	318	209	60.34	39.66	17100	18300	19500	RMT 84.36	7743	14720
																			NR 60.28	4276	8130
Flicker/ACSR/TW	477	13	18	91.3	0.1628	7x0.0940	0.2820	0.4234	0.3748	0.78	612	448	164	73.14	26.86	17200	18100	19000	RM 84.36	6765	11050
																			NR 60.28	4506	7360
Hawk/ACSR/TW	477	16	18	91.3	0.1628	7x0.1053	0.3159	0.4355	0.3745	0.79	655	448	206	68.47	31.53	19400	20500	21700	RMT 84.36	7233	11050
																			NR 60.28	3620	5530
Hen/ACSR/TW	477	23	16	88.7	0.1727	7x0.1261	0.3783	0.4620	0.3746	0.83	746	450	296	60.34	39.66	23600	25300	27000	RM68.38	7288	9770
																			NR 60.28	3648	4890
Parakeet/ACSR/TW	556.5	13	18	92.0	0.1758	7x0.1015	0.3045	0.4938	0.4372	0.84	714	522	192	73.15	26.85	20000	21100	22200	RM 68.38	6770	9480
																			NR 60.28	3385	4740
Dove/ACSR/TW	556.5	16	20	91.8	0.1668	7x0.1138	0.3414	0.5083	0.4371	0.85	764	523	241	68.45	31.55	22600	24000	25300	RMT 84.36	8036	10520
																			NR 60.28	4018	5260
Rook/ACSR/TW	636	13	18	92.6	0.1880	7x0.1085	0.3255	0.5641	0.4994	0.89	816	597	219	73.15	26.85	22900	24100	25400	RM 68.38	6766	8290
																			NR 60.28	3387	4150
Grosbeak/ACSR/TW	636	16	20	92.0	0.1783	7x0.1216	0.3648	0.5809	0.4996	0.91	873	598	275	68.47	31.53	25400	27000	28600	RMT 84.36	8030	9200
																			NR 66.28	4015	4600
Tern/ACSR/TW	795	7	17	93.5	0.2163	7x0.0888	0.2664	0.6680	0.6247	0.96	892	745	147	83.54	16.46	21900	22700	23500	RM 68.38	5601	6280
																			NR 60.28	2801	3140
Puffin/ACSR/TW	795	11	21	93.5	0.1945	7x0.1108	0.3324	0.6916	0.6241	0.98	974	746	229	76.55	23.45	26200	27500	28800	RMT 84.36	7542	7740
																			NR 60.28	3771	3870
Condor/ACSR/TW	795	13	21	93.0	0.1945	7x0.1213	0.3639	0.7051	0.6242	0.99	1020	746	274	73.15	26.85	28200	29800	31300	RMT 84.36	7896	7740
																			NR 60.28	3948	3870
Drake/ACSR/TW	795	16	20	93.1	0.1993	7x0.1360	0.4080	0.7259	0.6242	1.01	1091	747	344	68.45	31.55	31800	33800	35700	RMT 84.36	8042	7370
																			NR 60.28	4016	3680
Mallard/ACSR/TW	795	23	22	93.0	0.1901	19x0.0977	0.4885	0.7668	0.6244	1.046	1234	751	483	60.84	39.16	38700	41400	44000	RMT 84.36	9946	8060
																			NR 60.28	3973	3220
Phoenix/ACSR/TW	954	5	30	92.9	0.1784	7x0.0837	0.2511	0.7882	0.7497	1.04	1028	898	130	87.32	12.68	23800	24500	25200	RMT 84.45	9448	9190
																			NR 66.28	4729	4600
Rail/ACSR/TW	954	7	33	92.2	0.1700	7x0.0971	0.2913	0.8011	0.7493	1.06	1074	899	175	83.66	16.34	25900	26900	27900	RMT 84.45	10848	10100
																			RM 68.38	5424	5050
Cardinal/ACSR/TW	954	13	21	93.9	0.2131	7x0.1329	0.3987	0.8463	0.7492	1.08	1224	895	329	73.15	26.85	33500	35400	37200	RMT 84.36	7896	6450
																			NR 60.28	3942	3220
Snowbird/ACSR/TW	1033.5	5	30	92.5	0.1856	7x0.0871	0.2613	0.8532	0.8115	1.09	1114	972	141	87.32	12.68	25700	26500	27300	RMT 84.45	9455	8490
																			RM 66.32	4722	4240
Ortolan/ACSR/TW	1033.5	7	33	92.3	0.1769	7x0.1010	0.3030	0.8673	0.8112	1.10	1163	973	190	83.68	16.32	28100	29100	30200	RMT 84.45	10842	9320
																			RM 68.38	5421	4660
Curlew/ACSR/TW	1033.5	13	21	93.7	0.2219	7x0.1383	0.4149	0.9170	0.8118	1.13	1326	970	356	73.15	26.85	36300	38300	40300	RMT 84.36	7890	5950
																			NR 60.28	3952	2980
Avocet/ACSR/TW	1113	5	30	93.0	0.1926	7x0.0904	0.2712	0.9186	0.8737	1.13	1199	1047	152	87.32	12.68	27500	28300	29200	RMT 84.36	9439	7870
																			RM 66.32	4726	3940
Bluejay/ACSR/TW	1113	7	33	92.7	0.1837	7x0.1049	0.3147	0.9351	0.8746	1.14	1253	1048	205	83.66	16.34	30300	31400	32600	RMT 84.45	10840	8650
																			RM 68.38	5426	4330
Finch/ACSR/TW	1113	13	39	91.9	0.1689	19x0.0862	0.4310	0.9845	0.8737	1.18	1427	1051	376	73.64	26.36	39100	41200	43200	RMT 90.45	14556	10200
																			RMT 84.36	7278	5100
Oxbird/ACSR/TW	1192.5	5	30	93.2	0.1993	7x0.0936	0.2808	0.9843	0.9361	1.17	1285	1122	163	87.31	12.69	29400	30400	31300	RMT 84.36	9446	7350
																			RM 66.32	4717	3670
Bunting/ACSR/TW	1192.5	7	33	93.0	0.1901	7x0.1086	0.3258	1.0016	0.9368	1.18	1343	1123	220	83.65	16.35	32400	33700	34900	RMT 84.45	10849	8080
																			RM 68.38	5425	4040

(1) Code words shown denote ACSR/TW with regular-strength Class A galvanized steel core (/GA2). See the Options section to find the appropriate code word modifier designation for alternative design options.

(2) Due to rounding, total values may not exactly equal the sum of the component values.

(3) Weights shown are for conductor only and do not include the reel. Normal length and shipping tolerances apply.

Dimensions and weights not designated minimum or maximum are nominal values and subject to manufacturing tolerances. In this context, weight means mass.

TransPowr® ACSR/TW Bare Overhead Conductor

Trapezoidal Aluminum Conductor Steel-Reinforced Concentric-Lay-Stranded

ACSR/TW (ELECTRICAL PROPERTIES) – REDUCED DIAMETER - CONDUCTORS SIZED TO HAVE EQUIVALENT CIRCULAR MIL AREA TO REGULAR ACSR

CODE WORD (1)	SIZE AWG OR kcmil	TYPE	NO. AL WIRES	FILL FACTOR	EQUIVALENT AL DIA. INCHES	STEEL CORE NO. X DIA. INCHES	STEEL CORE O.D. INCHES	CROSS-SECTION SQ. INCHES		O.D. INCHES	RESISTANCE (4) OHMS/1000 FT			AMPACITY 75°C (5)	GEOMETRIC MEAN RADIUS FT	INDUCTIVE REACTANCE OHM/1000 FT (6)	CAPACITIVE REACTANCE MEGA OHM 1000 FT (6)
								TOTAL	AL		DC @ 20°C	AC @ 25°C	AC @ 75°C				
Oriole/ACSR/TW	336.4	23	17	88.7	0.1407	7x0.1059	0.3177	0.3258	0.2642	0.69	0.0502	0.0513	0.0613	525	0.0236	0.0861	0.5553
Flicker/ACSR/TW	477	13	18	91.3	0.1628	7x0.0940	0.2820	0.4234	0.3748	0.78	0.0357	0.0366	0.0437	640	0.0259	0.0839	0.5375
Hawk/ACSR/TW	477	16	18	91.3	0.1628	7x0.1053	0.3159	0.4355	0.3745	0.79	0.0356	0.0364	0.0435	645	0.0266	0.0834	0.5349
Hen/ACSR/TW	477	23	16	88.7	0.1727	7x0.1261	0.3783	0.4620	0.3746	0.83	0.0354	0.0362	0.0433	655	0.0280	0.0822	0.5278
Parakeet/ACSR/TW	556.5	13	18	92.0	0.1758	7x0.1015	0.3045	0.4938	0.4372	0.84	0.0306	0.0314	0.0375	705	0.0279	0.0822	0.5259
Dove/ACSR/TW	556.5	16	20	91.8	0.1668	7x0.1138	0.3414	0.5083	0.4371	0.85	0.0305	0.0313	0.0374	710	0.0287	0.0816	0.5232
Rook/ACSR/TW	636	13	18	92.6	0.1880	7x0.1085	0.3255	0.5641	0.4994	0.89	0.0268	0.0275	0.0329	765	0.0298	0.0808	0.5159
Grosbeak/ACSR/TW	636	16	20	92.0	0.1783	7x0.1216	0.3648	0.5809	0.4996	0.91	0.0267	0.0274	0.0327	770	0.0307	0.0801	0.5129
Tern/ACSR/TW	795	7	17	93.5	0.2163	7x0.0888	0.2664	0.6680	0.6247	0.96	0.0215	0.0223	0.0266	870	0.0315	0.0795	0.5042
Puffin/ACSR/TW	795	11	21	93.5	0.1945	7x0.1108	0.3324	0.6916	0.6241	0.98	0.0215	0.0222	0.0264	875	0.0327	0.0786	0.5009
Condor/ACSR/TW	795	13	21	93.0	0.1945	7x0.1213	0.3639	0.7051	0.6242	0.99	0.0214	0.0221	0.0264	880	0.0333	0.0782	0.4987
Drake/ACSR/TW	795	16	20	93.1	0.1993	7x0.1360	0.4080	0.7259	0.6242	1.01	0.0213	0.0220	0.0262	885	0.0342	0.0776	0.4962
Mallard/ACSR/TW	795	23	22	93.0	0.1901	19x0.0977	0.4885	0.7668	0.6244	1.046	0.0213	0.0219	0.0261	895	0.0360	0.0764	0.4907
Phoenix/ACSR/TW	954	5	30	92.9	0.1784	7x0.0837	0.2511	0.7882	0.7497	1.04	0.0181	0.0190	0.0233	950	0.0343	0.0775	0.4910
Rail/ACSR/TW	954	7	33	92.2	0.1700	7x0.0971	0.2913	0.8011	0.7493	1.06	0.0180	0.0189	0.0232	955	0.0350	0.0771	0.4889
Cardinal/ACSR/TW	954	13	21	93.9	0.2131	7x0.1329	0.3987	0.8463	0.7492	1.08	0.0178	0.0185	0.0221	985	0.0364	0.0762	0.4851
Snowbird/ACSR/TW	1033.5	5	30	92.5	0.1856	7x0.0871	0.2613	0.8532	0.8115	1.09	0.0167	0.0176	0.0215	995	0.0357	0.0766	0.4844
Ortolan/ACSR/TW	1033.5	7	33	92.3	0.1769	7x0.1010	0.3030	0.8673	0.8112	1.10	0.0167	0.0175	0.0215	1000	0.0364	0.0762	0.4827
Curlew/ACSR/TW	1033.5	13	21	93.7	0.2219	7x0.1383	0.4149	0.9170	0.8118	1.13	0.0165	0.0171	0.0204	1035	0.0379	0.0752	0.4787
Avocet/ACSR/TW	1113	5	30	93.0	0.1926	7x0.0904	0.2712	0.9186	0.8737	1.13	0.0155	0.0164	0.0200	1045	0.0370	0.0758	0.4790
Bluejay/ACSR/TW	1113	7	33	92.7	0.1837	7x0.1049	0.3147	0.9351	0.8746	1.14	0.0155	0.0163	0.0200	1050	0.0377	0.0753	0.4772
Finch/ACSR/TW	1113	13	39	91.9	0.1689	19x0.0862	0.4310	0.9845	0.8737	1.18	0.0154	0.0162	0.0198	1065	0.0399	0.0740	0.4716
Oxbird/ACSR/TW	1192.5	5	30	93.2	0.1993	7x0.0936	0.2808	0.9843	0.9361	1.17	0.0145	0.0154	0.0188	1090	0.0382	0.0750	0.4738
Bunting/ACSR/TW	1192.5	7	33	93.0	0.1901	7x0.1086	0.3258	1.0016	0.9368	1.18	0.0144	0.0153	0.0187	1095	0.0390	0.0746	0.4720

(1) Code words shown denote ACSR/TW with regular-strength Class A galvanized steel core (GA2). See the Options section to find the appropriate code word modifier designation for alternative design options.
 (4) Based on a conductivity of 61.2% (minimum lot average) IACS at 20°C for aluminum and 8% IACS at 20°C for the steel core. AC resistance for single-layer and three-layer designs approximates the effects of core magnetization. To convert to ohms/mile, multiply by 5.28. To convert to ohms/km, multiply by 3.281.
 (5) Based on a conductor temperature of 75°C at 60 Hz and the following conditions: 25°C ambient temperature, 2 ft/sec crosswind (90° to conductor), 0.5 coefficient of emissivity, 0.5 coefficient of absorptivity, 30° northern latitude, sea level elevation, 90° azimuth of line (East-West), clear atmosphere, and a date and time of noon on July 1 (resulting in 96.0 W/ft² of solar and sky radiated heat). Actual ampacity will differ based on local conditions. For specific ampacities, please contact your General Cable sales representative.
 (6) Values for inductive reactance and capacitive reactance are expressed in terms of a 1 ft radius (30.48 cm). To convert the Geometric Mean Radius (GMR) to cm, divide the value by 0.03821. To convert inductive reactance to ohm/km, multiply the value by 3.281. To convert capacitive reactance to ohm/km, divide the value by 3.281.



TransPowr® ACSR/TW Bare Overhead Conductor

Trapezoidal Aluminum Conductor Steel-Reinforced Concentric-Lay-Stranded

ACSR/TW (MECHANICAL PROPERTIES) – REDUCED DIAMETER - CONDUCTORS SIZED TO HAVE EQUIVALENT CIRCULAR MIL AREA TO REGULAR ACSR

CODE WORD (1)	SIZE AWG OR kcmil	TYPE	NO. AL WIRES	FILL FACTOR	EQUIVALENT AL DIA. INCHES	STEEL CORE NO. X DIA. INCHES	STEEL CORE O.D. INCHES	CROSS-SECTION SQ. INCHES			APPROX. WEIGHT LB/1000 FT (2)			PERCENT BY MASS		RATED STRENGTH LBS			STANDARD PACKAGES (3)		
								TOTAL	AL	O.D. INCHES	TOTAL	AL	STEEL	AL	STEEL	GA2	GA3 (HS)	GA5 (UHS)	REEL DESIGNATION	WEIGHT LBS	LENGTH FEET
Grackle/ACSR/TW	1192.5	13	39	92.3	0.1749	19x0.0892	0.4460	1.0556	0.9369	1.22	1529	1126	403	73.65	26.35	41900	44100	46300	RMT 90.45	14569	9530
																			RM 72.36	7277	4760
Scissortail/ACSR/TW	1272	5	30	93.6	0.2059	7x0.0967	0.2901	1.0508	0.9994	1.20	1371	1197	174	87.30	12.70	31400	32400	33400	RMT 84.36	9460	6900
																			RM 66.32	4730	3450
Bittern/ACSR/TW	1272	7	33	93.3	0.1964	7x0.1121	0.3363	1.0685	0.9994	1.22	1432	1198	234	83.67	16.33	34600	35900	37200	RMT 84.45	10854	7580
																			RM 68.38	5427	3790
Pheasant/ACSR/TW	1272	13	39	93.0	0.1806	19x0.0921	0.4605	1.1252	0.9987	1.26	1630	1201	429	73.66	26.34	44100	46400	48800	RMT 90.45	14559	8930
																			RM 72.36	7272	4460
Dipper/ACSR/TW	1351.5	7	33	93.5	0.2024	7x0.1155	0.3465	1.1350	1.0616	1.25	1521	1273	248	83.68	16.32	36700	38100	39500	RMT 84.45	10847	7130
																			RM 68.38	5416	3560
Martin/ACSR/TW	1351.5	13	39	93.0	0.1861	19x0.0949	0.4745	1.1954	1.0610	1.30	1732	1276	456	73.68	26.32	46800	49300	51800	RMT 90.45	14548	8400
																			RM 72.36	7274	4200
Bobolink/ACSR/TW	1431	7	33	93.0	0.2083	7x0.1189	0.3567	1.2020	1.1243	1.29	1611	1348	263	83.67	16.33	38900	40400	41900	RMT 84.45	10842	6730
																			RM 68.38	5413	3360
Plover/ACSR/TW	1431	13	39	93.0	0.1916	19x0.0977	0.4885	1.2666	1.1242	1.33	1834	1351	483	73.66	26.34	49600	52200	54900	RMT 90.45	14565	7940
																			RM 72.36	7282	3970
Lapwing/ACSR/TW	1590	7	36	93.0	0.2102	7x0.1253	0.3759	1.3351	1.2488	1.36	1790	1498	292	83.67	16.33	42200	43900	45500	RMT 84.45	11831	6610
																			RM 68.38	5906	3300
Falcon/ACSR/TW	1590	13	42	93.5	0.1946	19x0.1030	0.5150	1.4066	1.2483	1.40	2038	1501	537	73.65	26.35	55100	58000	61000	RMT 90.45	15674	7690
																			RMT 84.36	7827	3840
Chukar/ACSR/TW	1780	8	38	93.5	0.2164	19x0.0874	0.4370	1.5122	1.3982	1.45	2061	1674	387	81.24	18.76	50700	52800	54900	RMT 90.45	12859	6240
																			RM 68.38	6430	3120
Bluebird/ACSR/TW	2156	8	64	91.0	0.1835	19x0.0961	0.4805	1.8312	1.6934	1.61	2512	2045	467	81.39	18.61	61100	63700	66200	RMT 96.60	21629	8610
																			RM 84.45	10802	4300

ACSR/TW (MECHANICAL PROPERTIES) – EQUIVALENT DIAMETER - CONDUCTORS SIZED TO HAVE EQUIVALENT DIAMETER TO REGULAR ACSR

CODE WORD (1)	SIZE AWG OR kcmil	TYPE	NO. AL WIRES	FILL FACTOR	EQUIVALENT AL DIA. INCHES	STEEL CORE NO. X DIA. INCHES	STEEL CORE O.D. INCHES	CROSS-SECTION SQ. INCHES			APPROX. WEIGHT LB/1000 FT (2)			PERCENT BY MASS		RATED STRENGTH LBS			STANDARD PACKAGES (3)		
								TOTAL	AL	O.D. INCHES	TOTAL	AL	STEEL	AL	STEEL	GA2	GA3 (HS)	GA5 (UHS)	REEL DESIGNATION	WEIGHT LBS	LENGTH FEET
Calumet/ACSR/TW	565.3	16	20	91.5	0.1681	7x0.1146	0.3438	0.5161	0.4438	0.86	776	531	244	68.48	31.52	22900	24300	25700	RMT 84.36	8027	10350
																			NR 60.28	4010	5170
Mohawk/ACSR/TW	571.7	13	18	92.2	0.1782	7x0.1030	0.3090	0.5072	0.4489	0.85	734	537	197	73.10	26.90	20600	21700	22800	RM 66.38	6768	9220
																			NR 60.28	3384	4610
Oswego/ACSR/TW	664.8	16	20	92.3	0.1823	7x0.1244	0.3732	0.6073	0.5222	0.93	913	625	288	68.44	31.56	26600	28200	29900	RMT 84.36	8032	8800
																			NR 60.28	4016	4400
Mystic/ACSR/TW	666.6	13	20	92.3	0.1826	7x0.1111	0.3333	0.5915	0.5236	0.91	855	626	230	73.14	26.86	24000	25300	26600	RMT 84.36	7519	8790
																			NR 60.28	3755	4390
Wabash/ACSR/TW	762.8	16	20	92.9	0.1953	7x0.1331	0.3993	0.6963	0.5989	0.99	1046	717	330	68.49	31.51	30500	32400	34200	RMT 84.36	8026	7670
																			NR 60.28	4008	3830
Maumee/ACSR/TW	768.2	13	20	93.0	0.1960	7x0.1195	0.3585	0.6817	0.6032	0.98	987	721	266	73.07	26.93	27700	29200	30700	RMT 84.36	7520	7620
																			NR 60.28	3760	3810
Kettle/ACSR/TW	957.2	7	33	92.2	0.1703	7x0.0973	0.2919	0.8038	0.7518	1.06	1078	902	176	83.65	16.35	26000	27000	28000	RMT 84.45	10843	10060
																			RM 68.38	5421	5030
Suwanee/ACSR/TW	959.6	16	22	93.4	0.2089	7x0.1493	0.4479	0.8764	0.7539	1.11	1317	902	415	68.49	31.51	37200	40100	42500	RMT 84.36	8834	6710
																			RM 66.32	4410	3350
Columbia/ACSR/TW	966.2	13	21	93.6	0.2145	7x0.1338	0.4014	0.8576	0.7591	1.09	1240	907	333	73.13	26.87	34000	35800	37700	RMT 84.36	7899	6370
																			RM 66.32	3943	3180

(1) Code words shown denote ACSR/TW with regular-strength Class A galvanized steel core (/GA2). See the Options section to find the appropriate code word modifier designation for alternative design options.

(2) Due to rounding, total values may not exactly equal the sum of the component values.

(3) Weights shown are for conductor only and do not include the reel. Normal length and shipping tolerances apply.

Dimensions and weights not designated minimum or maximum are nominal values and subject to manufacturing tolerances. In this context, weight means mass.

TransPowr® ACSR/TW Bare Overhead Conductor

Trapezoidal Aluminum Conductor Steel-Reinforced Concentric-Lay-Stranded

ACSR/TW (ELECTRICAL PROPERTIES) – REDUCED DIAMETER - CONDUCTORS SIZED TO HAVE EQUIVALENT CIRCULAR MIL AREA TO REGULAR ACSR

CODE WORD (1)	SIZE AWG OR kcmil	TYPE	NO. AL WIRES	FILL FACTOR	EQUIVALENT AL DIA. INCHES	STEEL CORE NO. X DIA. INCHES	STEEL CORE O.D. INCHES	CROSS-SECTION SQ. INCHES		O.D. INCHES	RESISTANCE (4) OHMS/1000 FT			AMPACITY 75°C (5)	GEOMETRIC MEAN RADIUS FT	INDUCTIVE REACTANCE OHM/1000 FT (6)	CAPACITIVE REACTANCE MEGA OHM 1000 FT (6)
								TOTAL	AL		DC @ 20°C	AC @ 25°C	AC @ 75°C				
Grackle/ACSR/TW	1192.5	13	39	92.3	0.1749	19x0.0892	0.4460	1.0556	0.9369	1.22	0.0144	0.0151	0.0185	1110	0.0412	0.0733	0.4665
Scissortail/ACSR/TW	1272	5	30	93.6	0.2059	7x0.0967	0.2901	1.0508	0.9994	1.20	0.0135	0.0145	0.0176	1130	0.0394	0.0743	0.4690
Bittern/ACSR/TW	1272	7	33	93.3	0.1964	7x0.1121	0.3363	1.0685	0.9994	1.22	0.0135	0.0144	0.0176	1135	0.0402	0.0739	0.4672
Pheasant/ACSR/TW	1272	13	39	93.0	0.1806	19x0.0921	0.4605	1.1252	0.9987	1.26	0.0135	0.0142	0.0174	1155	0.0424	0.0726	0.4619
Dipper/ACSR/TW	1351.5	7	33	93.5	0.2024	7x0.1155	0.3465	1.1350	1.0616	1.25	0.0127	0.0136	0.0166	1180	0.0414	0.0732	0.4626
Martin/ACSR/TW	1351.5	13	39	93.0	0.1861	19x0.0949	0.4745	1.1954	1.0610	1.30	0.0127	0.0135	0.0164	1195	0.0437	0.0719	0.4572
Bobolink/ACSR/TW	1431	7	33	93.0	0.2083	7x0.1189	0.3567	1.2020	1.1243	1.29	0.0120	0.0129	0.0157	1220	0.0427	0.0725	0.4578
Plover/ACSR/TW	1431	13	39	93.0	0.1916	19x0.0977	0.4885	1.2666	1.1242	1.33	0.0120	0.0128	0.0155	1240	0.0450	0.0713	0.4527
Lapwing/ACSR/TW	1590	7	36	93.0	0.2102	7x0.1253	0.3759	1.3351	1.2488	1.36	0.0108	0.0118	0.0142	1300	0.0450	0.0712	0.4495
Falcon/ACSR/TW	1590	13	42	93.5	0.1946	19x0.1030	0.5150	1.4066	1.2483	1.40	0.0108	0.0116	0.0140	1320	0.0474	0.0701	0.4448
Chukar/ACSR/TW	1780	8	38	93.5	0.2164	19x0.0874	0.4370	1.5122	1.3982	1.45	0.00964	0.0106	0.0127	1400	0.0482	0.0697	0.4398
Bluebird/ACSR/TW	2156	8	64	91.0	0.1835	19x0.0961	0.4805	1.8312	1.6934	1.61	0.00802	0.00900	0.0105	1585	0.0538	0.0672	0.4229

ACSR/TW (ELECTRICAL PROPERTIES) – EQUIVALENT DIAMETER - CONDUCTORS SIZED TO HAVE EQUIVALENT DIAMETER TO REGULAR ACSR

CODE WORD (1)	SIZE AWG OR kcmil	TYPE	NO. AL WIRES	FILL FACTOR	EQUIVALENT AL DIA. INCHES	STEEL CORE NO. X DIA. INCHES	STEEL CORE O.D. INCHES	CROSS-SECTION SQ. INCHES		O.D. INCHES	RESISTANCE (4) OHMS/1000 FT			AMPACITY 75°C (5)	GEOMETRIC MEAN RADIUS FT	INDUCTIVE REACTANCE OHM/1000 FT (6)	CAPACITIVE REACTANCE MEGA OHM 1000 FT (6)
								TOTAL	AL		DC @ 20°C	AC @ 25°C	AC @ 75°C				
Calument/ACSR/TW	565.3	16	20	91.5	0.1681	7x0.1146	0.3438	0.5161	0.4438	0.86	0.0300	0.0308	0.0368	715	0.0290	0.0814	0.5217
Mohawk/ACSR/TW	571.7	13	18	92.2	0.1782	7x0.1030	0.3090	0.5072	0.4489	0.85	0.0298	0.0306	0.0365	715	0.0283	0.0820	0.5239
Oswego/ACSR/TW	664.8	16	20	92.3	0.1823	7x0.1244	0.3732	0.6073	0.5222	0.93	0.0255	0.0262	0.0313	795	0.0313	0.0796	0.5096
Mystic/ACSR/TW	666.6	13	20	92.3	0.1826	7x0.1111	0.3333	0.5915	0.5236	0.91	0.0255	0.0263	0.0314	790	0.0306	0.0801	0.5120
Wabash/ACSR/TW	762.8	16	20	92.9	0.1953	7x0.1331	0.3993	0.6963	0.5989	0.99	0.0222	0.0229	0.0273	865	0.0335	0.0781	0.4993
Maumee/ACSR/TW	768.2	13	20	93.0	0.1960	7x0.1195	0.3585	0.6817	0.6032	0.98	0.0222	0.0229	0.0273	860	0.0328	0.0786	0.5014
Kettle/ACSR/TW	957.2	7	33	92.2	0.1703	7x0.0973	0.2919	0.8038	0.7518	1.06	0.0180	0.0189	0.0232	955	0.0350	0.0770	0.4886
Suwanee/ACSR/TW	959.6	16	22	93.4	0.2089	7x0.1493	0.4479	0.8764	0.7539	1.11	0.0177	0.0183	0.0218	995	0.0376	0.0754	0.4817
Columbia/ACSR/TW	966.2	13	21	93.6	0.2145	7x0.1338	0.4014	0.8576	0.7591	1.09	0.0176	0.0183	0.0218	995	0.0367	0.0760	0.4839

(1) Code words shown denote ACSR/TW with regular-strength Class A galvanized steel core (GA2). See the Options section to find the appropriate code word modifier designation for alternative design options.
 (4) Based on a conductivity of 61.2% (minimum lot average) IACS at 20°C for aluminum and 8% IACS at 20°C for the steel core. AC resistance for single-layer and three-layer designs approximates the effects of core magnetization. To convert to ohms/mile, multiply by 5.28. To convert to ohms/km, multiply by 3.281.
 (5) Based on a conductor temperature of 75°C at 60 Hz and the following conditions: 25°C ambient temperature, 2 ft/sec crosswind (90° to conductor), 0.5 coefficient of emissivity, 0.5 coefficient of absorptivity, 30° northern latitude, sea level elevation, 90° azimuth of line (East-West), clear atmosphere, and a date and time of noon on July 1 (resulting in 96.0 W/ft² of solar and sky radiated heat). Actual ampacity will differ based on local conditions. For specific ampacities, please contact your General Cable sales representative.
 (6) Values for inductive reactance and capacitive reactance are expressed in terms of a 1 ft radius (30.48 cm). To convert the Geometric Mean Radius (GMR) to cm, divide the value by 0.03821. To convert inductive reactance to ohm/km, multiply the value by 3.281. To convert capacitive reactance to ohm/km, divide the value by 3.281.



TransPowr® ACSR/TW Bare Overhead Conductor

Trapezoidal Aluminum Conductor Steel-Reinforced Concentric-Lay-Stranded

ACSR/TW (MECHANICAL PROPERTIES) – EQUIVALENT DIAMETER - CONDUCTORS SIZED TO HAVE EQUIVALENT DIAMETER TO REGULAR ACSR																					
CODE WORD (1)	SIZE AWG OR kcmil	TYPE	NO. AL WIRES	FILL FACTOR	EQUIVALENT AL DIA. INCHES	STEEL CORE NO. X DIA. INCHES	STEEL CORE O.D. INCHES	CROSS-SECTION SQ. INCHES			APPROX. WEIGHT LB/1000 FT (2)			PERCENT BY MASS		RATED STRENGTH LBS			STANDARD PACKAGES (3)		
								TOTAL	AL	O.D. INCHES	TOTAL	AL	STEEL	AL	STEEL	GA2	GA3 (HS)	GA5 (UHS)	REEL DESIGNATION	WEIGHT LBS	LENGTH FEET
Genesee/ACSR/TW	1158.0	7	33	92.5	0.1873	7x0.1078	0.3234	0.9732	0.9094	1.16	1307	1091	216	83.45	16.55	31600	32900	34100	RMT 84.45	10874	8320
																			RM 68.38	5437	4160
Hudson/ACSR/TW	1158.4	13	26	93.7	0.2111	7x0.1467	0.4401	1.0279	0.9096	1.20	1488	1087	401	73.08	26.92	39600	42500	44700	RMT 84.36	9776	6570
																			RM 66.32	4880	3280
Cheyenne/ACSR/TW	1168.1	5	30	92.9	0.1973	7x0.0926	0.2778	0.9642	0.9170	1.16	1259	1099	160	87.32	12.68	28800	29700	30700	RMT 84.45	9441	7500
																			RM 66.32	4720	3750
Yukon/ACSR/TW	1233.6	13	39	91.0	0.1778	19x0.0910	0.4550	1.0923	0.9688	1.25	1584	1165	419	73.53	26.47	42900	45200	47500	RMT 90.45	14588	9210
																			RMT 84.36	7286	4600
Nelson/ACSR/TW	1257.1	7	35	92.4	0.1895	7x0.1115	0.3345	1.0558	0.9875	1.21	1415	1184	231	83.65	16.35	34200	35500	36800	RMT 84.45	11508	8130
																			RM 68.38	5747	4060
Catawba/ACSR/TW	1272.0	5	30	93.3	0.2059	7x0.0967	0.2901	1.0507	0.9993	1.20	1371	1197	174	87.30	12.70	31400	32400	33400	RMT 84.36	5333	3890
																			RM 66.32	4716	3440
Thames/ACSR/TW	1334.6	13	39	92.6	0.1850	19x0.0944	0.4720	1.1808	1.0479	1.29	1711	1260	451	73.64	26.36	46300	48700	51200	RMT 90.45	14562	8510
																			RM 72.36	7273	4250
Mackenzie/ACSR/TW	1359.7	7	36	92.9	0.1943	7x0.1159	0.3477	1.1413	1.0674	1.26	1531	1281	250	83.67	16.33	36900	38400	39800	RMT 84.45	11832	7730
																			RM 68.38	5909	3860
Truckee/ACSR/TW	1372.5	5	30	93.6	0.2139	7x0.1004	0.3012	1.1337	1.0783	1.25	1479	1291	188	87.32	12.68	33400	34500	35500	RMT 84.36	9451	6390
																			RM 66.32	4718	3190
Merrimack/ACSR/TW	1433.6	13	39	92.1	0.1917	19x0.0978	0.4890	1.2682	1.1255	1.34	1838	1354	484	73.65	26.35	49700	52300	55000	RMT 90.45	14555	7920
																			RM 72.36	7278	3960
Miramichi/ACSR/TW	1455.3	7	36	93.4	0.2010	7x0.1200	0.3600	1.2219	1.1427	1.30	1639	1371	268	83.64	16.36	39200	40700	42200	RMT 84.45	11832	7220
																			RM 68.38	5916	3610
St. Croix/ACSR/TW	1467.8	5	30	93.4	0.2212	7x0.1041	0.3123	1.2127	1.1532	1.29	1583	1381	202	87.26	12.74	35800	36900	38100	RMT 84.36	10320	6520
																			RM 66.32	5160	3260
Rio Grande/ACSR/TW	1533.3	13	39	93.2	0.1983	19x0.1012	0.5060	1.3574	1.2046	1.38	1966	1448	518	73.63	26.37	53200	56000	58900	RMT 90.45	14569	7410
																			RM 72.36	7275	3700
Potomac/ACSR/TW	1557.4	7	36	93.2	0.2080	7x0.1241	0.3723	1.3084	1.2237	1.35	1754	1467	287	83.65	16.35	41900	43600	45200	RMT 84.45	11836	6750
																			RM 68.38	5909	3370
Platte/ACSR/TW	1569.0	5	33	93.7	0.2181	7x0.1074	0.3222	1.2962	1.2328	1.33	1691	1476	215	87.30	12.70	38200	39400	40600	RMT 84.45	10383	6140
																			RM 68.38	5192	3070
Pecos/ACSR/TW	1622.0	13	39	93.1	0.2039	19x0.1064	0.5320	1.4425	1.2736	1.42	2105	1531	573	72.77	27.23	57500	60600	63800	RMT 90.45	14732	7000
																			RM 72.36	7366	3500
Schuykill/ACSR/TW	1657.4	7	36	93.5	0.2145	7x0.1280	0.3840	1.3912	1.3012	1.39	1866	1561	305	83.66	16.34	44000	45700	47500	RMT 84.45	11831	6340
																			RM 68.38	5915	3170
James/ACSR/TW	1730.6	13	39	92.5	0.2107	19x0.1075	0.5375	1.5322	1.3598	1.47	2219	1634	585	73.64	26.36	59400	62600	65800	RMT 90.45	14557	6560
																			RM 72.36	7278	3280
Pee Dee/ACSR/TW	1758.6	7	37	93.0	0.2180	7x0.1319	0.3957	1.4764	1.3807	1.43	1980	1656	324	83.65	16.35	46700	48500	50400	RMT 90.45	12159	6140
																			RM 68.38	6079	3070
Cumberland/ACSR/TW	1926.9	13	42	93.3	0.2142	19x0.1133	0.5665	1.7044	1.5129	1.54	2469	1819	650	73.68	26.32	66000	69600	73100	RMT 90.45	15679	6350
																			RMT 84.36	7827	3170
Athabaska/ACSR/TW	1949.6	7	42	93.4	0.2155	7x0.1392	0.4176	1.6384	1.5318	1.50	2197	1836	361	83.58	16.42	51900	53900	56000	RMT 90.45	13819	6290
																			RM 72.36	6898	3140
Powder/ACSR/TW	2153.8	8	64	92.2	0.1834	19x0.0961	0.4805	1.8293	1.6915	1.60	2510	2042	467	81.37	18.63	61100	63600	66200	RMT 96.60	21611	8610
																			RMT 84.45	10793	4300
Santee/ACSR/TW	2627.3	8	64	93.1	0.2027	19x0.1062	0.5310	2.2328	2.0645	1.76	3062	2492	571	81.36	18.64	74500	77700	80800	RMT 96.60	21621	7060
																			RMT 84.45	10810	3530

(1) Code words shown denote ACSR/TW with regular-strength Class A galvanized steel core (GA2). See the Options section to find the appropriate code word modifier designation for alternative design options.

(2) Due to rounding, total values may not exactly equal the sum of the component values.

(3) Weights shown are for conductor only and do not include the reel. Normal length and shipping tolerances apply.

Dimensions and weights not designated minimum or maximum are nominal values and subject to manufacturing tolerances. In this context, weight means mass.

TransPwr® ACSR/TW Bare Overhead Conductor

Trapezoidal Aluminum Conductor Steel-Reinforced Concentric-Lay-Stranded

ACSR/TW (ELECTRICAL PROPERTIES) – EQUIVALENT DIAMETER - CONDUCTORS SIZED TO HAVE EQUIVALENT DIAMETER TO REGULAR ACSR

CODE WORD (1)	SIZE AWG OR kcmil	TYPE	NO. AL WIRES	FILL FACTOR	EQUIVALENT AL DIA. INCHES	STEEL CORE NO. X DIA. INCHES	STEEL CORE O.D. INCHES	CROSS-SECTION SQ. INCHES		O.D. INCHES	RESISTANCE (4) OHMS/1000 FT			AMPACITY 75°C (5)	GEOMETRIC MEAN RADIUS FT	INDUCTIVE REACTANCE OHM/1000 FT (6)	CAPACITIVE REACTANCE MEGA OHM 1000 FT (6)
								TOTAL	AL		DC @ 20°C	AC @ 25°C	AC @ 75°C				
Genesee/ACSR/TW	1158.0	7	33	92.5	0.1873	7x0.1078	0.3234	0.9732	0.9094	1.16	0.0149	0.0157	0.0192	1075	0.0385	0.0748	0.4739
Hudson/ACSR/TW	1158.4	13	26	93.7	0.2111	7x0.1467	0.4401	1.0279	0.9096	1.20	0.0147	0.0154	0.0183	1110	0.0402	0.0738	0.4697
Cheyenne/ACSR/TW	1168.1	5	30	92.9	0.1973	7x0.0926	0.2778	0.9642	0.9170	1.16	0.0148	0.0157	0.0191	1075	0.0379	0.0752	0.4751
Yukon/ACSR/TW	1233.6	13	39	91.0	0.1778	19x0.0910	0.4550	1.0923	0.9688	1.25	0.0139	0.0147	0.0179	1135	0.0422	0.0728	0.4628
Nelson/ACSR/TW	1257.1	7	35	92.4	0.1895	7x0.1115	0.3345	1.0558	0.9875	1.21	0.0137	0.0146	0.0178	1130	0.0402	0.0739	0.4674
Catawba/ACSR/TW	1272.0	5	30	93.3	0.2059	7x0.0967	0.2901	1.0507	0.9993	1.20	0.0135	0.0145	0.0176	1130	0.0395	0.0743	0.4688
Thames/ACSR/TW	1334.6	13	39	92.6	0.1850	19x0.0944	0.4720	1.1808	1.0479	1.29	0.0128	0.0136	0.0166	1190	0.0435	0.0720	0.4579
Mackenzie/ACSR/TW	1359.7	7	36	92.9	0.1943	7x0.1159	0.3477	1.1413	1.0674	1.26	0.0127	0.0136	0.0165	1185	0.0417	0.0730	0.4617
Truckee/ACSR/TW	1372.5	5	30	93.6	0.2139	7x0.1004	0.3012	1.1337	1.0783	1.25	0.0126	0.0135	0.0164	1185	0.0409	0.0734	0.4631
Merrimack/ACSR/TW	1433.6	13	39	92.1	0.1917	19x0.0978	0.4890	1.2682	1.1255	1.34	0.0119	0.0127	0.0155	1240	0.0452	0.0712	0.4519
Miramichi/ACSR/TW	1455.3	7	36	93.4	0.2010	7x0.1200	0.3600	1.2219	1.1427	1.30	0.0118	0.0127	0.0155	1235	0.0430	0.0723	0.4568
St. Croix/ACSR/TW	1467.8	5	30	93.4	0.2212	7x0.1041	0.3123	1.2127	1.1532	1.29	0.0117	0.0127	0.0154	1235	0.0424	0.0726	0.4576
Rio Grande/ACSR/TW	1533.3	13	39	93.2	0.1983	19x0.1012	0.5060	1.3574	1.2046	1.38	0.0112	0.0120	0.0145	1295	0.0466	0.0705	0.4474
Potomac/ACSR/TW	1557.4	7	36	93.2	0.2080	7x0.1241	0.3723	1.3084	1.2237	1.35	0.0111	0.0120	0.0145	1285	0.0445	0.0715	0.4513
Platte/ACSR/TW	1569.0	5	33	93.7	0.2181	7x0.1074	0.3222	1.2962	1.2328	1.33	0.0110	0.0120	0.0145	1285	0.0438	0.0719	0.4527
Pecos/ACSR/TW	1622.0	13	39	93.1	0.2039	19x0.1064	0.5320	1.4425	1.2736	1.42	0.0105	0.0113	0.0138	1340	0.0482	0.0697	0.4424
Schuylkill/ACSR/TW	1657.4	7	36	93.5	0.2145	7x0.1280	0.3840	1.3912	1.3012	1.39	0.0104	0.0113	0.0137	1335	0.0459	0.0708	0.4467
James/ACSR/TW	1730.6	13	39	92.5	0.2107	19x0.1075	0.5375	1.5322	1.3598	1.47	0.00989	0.0107	0.0130	1390	0.0496	0.0690	0.4374
Pee Dee/ACSR/TW	1758.6	7	37	93.0	0.2180	7x0.1319	0.3957	1.4764	1.3807	1.43	0.00979	0.0108	0.0130	1380	0.0474	0.0701	0.4416
Cumberland/ACSR/TW	1926.9	13	42	93.3	0.2142	19x0.1133	0.5665	1.7044	1.5129	1.54	0.00889	0.00974	0.0117	1485	0.0522	0.0679	0.4296
Athabaska/ACSR/TW	1949.6	7	42	93.4	0.2155	7x0.1392	0.4176	1.6384	1.5318	1.50	0.00883	0.00985	0.0118	1470	0.0499	0.0689	0.4338
Powder/ACSR/TW	2153.8	8	64	92.2	0.1834	19x0.0961	0.4805	1.8293	1.6915	1.60	0.00803	0.00900	0.0105	1580	0.0535	0.0673	0.4239
Santee/ACSR/TW	2627.3	8	64	93.1	0.2027	19x0.1062	0.5310	2.2328	2.0645	1.76	0.00658	0.00767	0.00886	1765	0.0589	0.0651	0.4090

(1) Code words shown denote ACSR/TW with regular-strength Class A galvanized steel core (/GA2). See the Options section to find the appropriate code word modifier designation for alternative design options.
 (4) Based on a conductivity of 61.2% (minimum lot average) IACS at 20°C for aluminum and 8% IACS at 20°C for the steel core. AC resistance for single-layer and three-layer designs approximates the effects of core magnetization. To convert to ohms/mile, multiply by 5.28. To convert to ohms/km, multiply by 3.281.
 (5) Based on a conductor temperature of 75°C at 60 Hz and the following conditions: 25°C ambient temperature, 2 ft/sec crosswind (90° to conductor), 0.5 coefficient of emissivity, 0.5 coefficient of absorptivity, 30° northern latitude, sea level elevation, 90° azimuth of line (East-West), clear atmosphere, and a date and time of noon on July 1 (resulting in 96.0 W/ft² of solar and sky radiated heat). Actual ampacity will differ based on local conditions. For specific ampacities, please contact your General Cable sales representative.
 (6) Values for inductive reactance and capacitive reactance are expressed in terms of a 1 ft radius (30.48 cm). To convert the Geometric Mean Radius (GMR) to cm, divide the value by 0.03821. To convert inductive reactance to ohm/km, multiply the value by 3.281. To convert capacitive reactance to ohm/km, divide the value by 3.281.



Notes

TransPowr® ACSS Bare Overhead Conductor

Aluminum Conductor Steel-Supported Concentric-Lay-Stranded

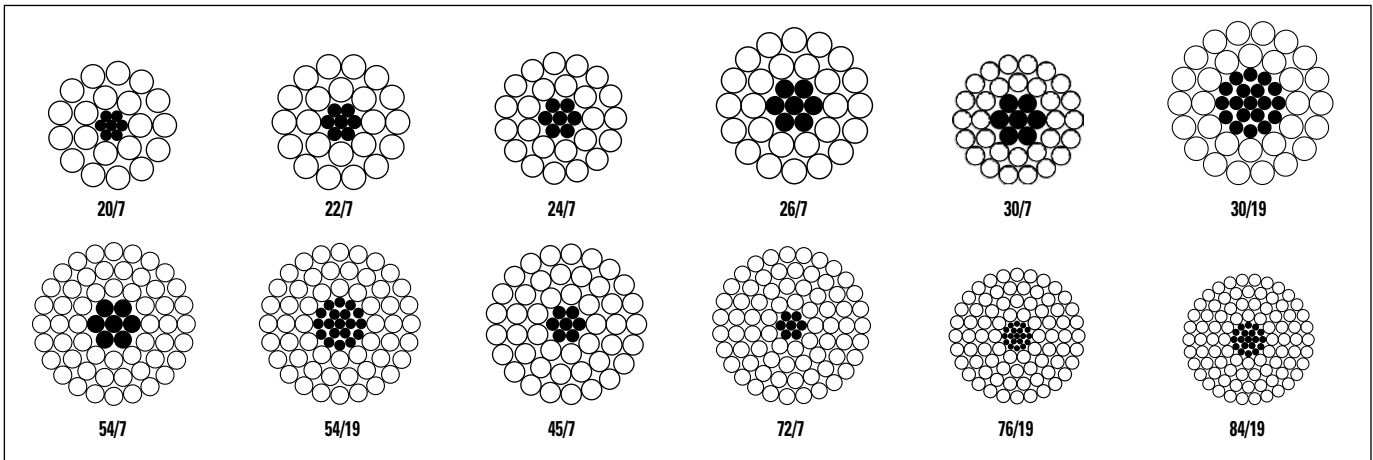

Product Construction:

Complete Conductor:

ACSS is a composite concentric-lay-stranded cable. ACSS conductors are manufactured in accordance with the latest issue of ASTM B856.

The steel strands form the central core of the cable, around which is stranded one or more layers of aluminum 1350-0 wires. The "0" temper of the aluminum, a fully annealed or soft temper, causes most or all of the mechanical load on ACSS to be carried by the steel. Standard ACSS designs are manufactured with regular-strength Class A zinc-5% aluminum mischmetal alloy-coated steel core (/MA2). The steel core may consist of 7, 19, 37 or more wires.

Features and Benefits:

ACSS conductors are similar to conventional ACSR with some very important additional advantages. ACSS can operate continuously at high temperatures up to 250°C without damage, allowing for a significant increase in conductor current-carrying capacity.

ACSS sags less under emergency electrical loadings than ACSR, it is self-damping, and its final sags are not affected by long-term creep of the aluminum.

Applications:

Aluminum Conductor Steel-Supported (ACSS) is used for overhead transmission lines. It is especially useful in reconductoring applications requiring increased current with existing tensions and clearances; new line applications where structures can be economized due to reduced sag; new line applications requiring high emergency loadings; and lines where aeolian vibration is a problem.

Options:

- High-strength Class A zinc-5% aluminum mischmetal alloy-coated steel core (/MA3)
- Extra-high-strength Class A zinc-5% aluminum mischmetal alloy-coated steel core (/MA4)
- Ultra-high-strength Class A zinc-5% aluminum mischmetal alloy-coated steel core (/MA5)
- Aluminum-clad steel core (/AW) — see ACSS/AW catalog section
- 250°C operating temperature rating utilizing either the zinc-5% aluminum mischmetal alloy-coated steel core wires or the aluminum-clad steel core wires
- Trapezoidal-shaped aluminum strands (/TW)
- Non-specular surface finish (/NS)
- E3X® surface coating (/E3X)

At the present time, CAN/CSA C61089 does not recognize ACSS conductor designs. The information provided on the following pages is from our US catalog.

For other conductor sizes, designs and/or specific installation requirements not shown in the tables, contact your General Cable sales representative or e-mail infoca@generalcable.com.

TransPowr® ACSS Bare Overhead Conductor

Aluminum Conductor Steel-Supported Concentric-Lay-Stranded

ACSS, CONCENTRIC-LAY-STRANDED (MECHANICAL PROPERTIES)

CODE WORD (1)	SIZE AWG OR kcmil	STRANDING NO. X DIA. INCHES		CROSS-SECTION SQ. INCHES		O.D. INCHES	APPROX. WEIGHT LB/1000 FT (2)			PERCENT BY MASS		RATED STRENGTH LBS			STANDARD PACKAGES (3)		
		AL	STEEL	TOTAL	AL		TOTAL	AL	STEEL	AL	STEEL	MA2	MA3	MA5	REEL DESIGNATION	WEIGHT LBS	LENGTH FEET
Spoonbill/ACSS	266.8	22x0.1101	7x0.0612	0.2300	0.2095	0.624	321	251	70	78.28	21.72	6030	6550	7580	RM 68.38	2810	8755
Scaup/ACSS	266.8	24x0.1054	7x0.0703	0.2366	0.2095	0.633	343	251	92	73.20	26.80	7410	8090	9450	RM 68.38	3265	9520
Partridge/ACSS	266.8	26x0.1013	7x0.0788	0.2437	0.2096	0.642	367	251	116	68.50	31.50	8880	9730	11440	RM 68.38	3790	10330
Junco/ACSS	266.8	30x0.0943	7x0.0943	0.2584	0.2095	0.660	417	252	166	60.35	39.65	11700	13000	15200	RM 68.38	4970	11890
Ostrich/ACSS	300	26x0.1074	7x0.0835	0.2739	0.2355	0.680	412	283	130	68.53	31.47	10000	10900	12800	RM 68.38	3785	9190
Trogon/ACSS	336.4	20x0.1297	7x0.0576	0.2825	0.2642	0.692	379	317	62	83.69	16.31	5990	6440	7350	RM 68.38	4780	12610
Woodcock/ACSS	336.4	22x0.1237	7x0.0687	0.2903	0.2644	0.701	405	317	88	78.29	21.71	7610	8250	9550	RMT 84.36 RM 68.38	5620 2810	13880 6940
Widgeon/ACSS	336.4	24x0.1184	7x0.0789	0.2985	0.2642	0.710	433	317	116	73.22	26.78	9340	10200	11900	RMT 84.36 RM 68.38	6550 3275	15130 7565
Linnet/ACSS	336.4	26x0.1137	7x0.0884	0.3070	0.2640	0.720	462	317	145	68.54	31.46	11200	12300	14400	RMT 84.36 RM 68.38	7570 3785	16390 8195
Oriole/ACSS	336.4	30x0.1059	7x0.1059	0.3259	0.2642	0.741	526	318	209	60.34	39.66	14800	16300	19100	RM 68.38	4970	9430
Ptarmigan/ACSS	397.5	20x0.1410	7x0.0627	0.3339	0.3123	0.752	448	374	73	83.65	16.35	7090	7630	8710	RM 68.38	4780	10670
Stork/ACSS	397.5	22x0.1344	7x0.0747	0.3428	0.3121	0.762	478	374	104	78.28	21.72	8990	9760	11290	RMT 84.36 RM 68.38	5605 2805	11730 5865
Brant/ACSS	397.5	24x0.1287	7x0.0858	0.3527	0.3122	0.772	511	374	137	73.21	26.79	11000	12100	14100	RMT 84.36 RM 68.38	6535 3270	12790 6395
Ibis/ACSS	397.5	26x0.1236	7x0.0961	0.3627	0.3120	0.783	546	374	172	68.53	31.47	13000	14200	16500	RMT 84.36 RM 68.38	7575 3785	13870 6935
Lark/ACSS	397.5	30x0.1151	7x0.1151	0.3850	0.3121	0.806	622	375	247	60.35	39.65	17500	19300	22600	RM 68.38	4965	7980
Tailorbird/ACSS	477	20x0.1544	7x0.0686	0.4003	0.3746	0.824	537	449	88	83.69	16.31	8490	9140	10430	RM 68.38	4780	8900
Toucan/ACSS	477	22x0.1472	7x0.0818	0.4112	0.3744	0.834	574	449	125	78.30	21.70	10800	11700	13500	RMT 84.36 RM 68.38	5620 2810	9790 4895
Flicker/ACSS	477	24x0.1410	7x0.0940	0.4233	0.3747	0.846	614	449	164	73.20	26.80	13000	14200	16400	RMT 84.36 RM 68.38	6535 3265	10660 5330
Hawk/ACSS	477	26x0.1354	7x0.1053	0.4353	0.3744	0.858	656	449	206	68.52	31.48	15600	17100	19800	RMT 84.36 RM 68.38	7570 3785	11560 5780
Hen/ACSS	477	30x0.1261	7x0.1261	0.4621	0.3747	0.883	746	450	296	60.34	39.66	21000	22700	26700	RM 68.38	4960	6650
Heron/ACSS	500	30x0.1291	7x0.1291	0.4843	0.3927	0.904	782	472	310	60.35	39.65	22000	23800	27900	RM 68.38	4960	6345
Tody/ACSS	556.5	20x0.1668	7x0.0741	0.4672	0.4370	0.890	626	524	102	83.68	16.32	9900	10700	12200	RM 68.38	4770	7620
Sapsucker/ACSS	556.5	22x0.1590	7x0.0883	0.4797	0.4368	0.901	669	524	145	78.32	21.68	12600	13600	15800	RMT 84.36 RM 68.38	5615 2805	8390 4195
Parakeet/ACSS	556.5	24x0.1523	7x0.1015	0.4939	0.4372	0.914	716	524	192	73.22	26.78	15200	16600	19100	RMT 84.36 RM 68.38	6545 3270	9140 4570
Dove/ACSS	556.5	26x0.1463	7x0.1138	0.5083	0.4371	0.927	765	524	241	68.50	31.50	18200	19900	23100	RMT 84.36 RM 68.38	7580 3790	9910 4955
Eagle/ACSS	556.5	30x0.1362	7x0.1362	0.5391	0.4371	0.953	871	525	345	60.35	39.65	24500	26500	31100	RM 68.38	4960	5700
Peacock/ACSS	605	24x0.1588	7x0.1059	0.5370	0.4753	0.953	779	570	209	73.19	26.81	16500	18100	20800	RMT 84.36 RM 68.38	6550 3275	8410 4205
Squab/ACSS	605	26x0.1525	7x0.1186	0.5522	0.4749	0.966	832	570	262	68.52	31.48	19700	21700	25100	RMT 84.36 RM 68.38	7580 3790	9110 4555
Wood Duck/ACSS	605	30x0.1420	7x0.1420	0.5860	0.4751	0.994	947	571	375	60.35	39.65	26000	28300	33300	RM 68.38	4960	5245
Teal/ACSS	605	30x0.1420	19x0.0852	0.5834	0.4751	0.994	939	571	367	60.85	39.15	26600	29300	34700	RMT 84.45 RM 68.38	9840 4920	10490 5245
Turacos/ACSS	636	20x0.1783	7x0.0792	0.5339	0.4994	0.951	716	599	117	83.69	16.31	11300	12200	13900	RMT 84.36 RM 68.38	7160 4775	10000 6670
Goldfinch/ACSS	636	22x0.1700	7x0.0944	0.5483	0.4994	0.963	765	599	166	78.32	21.68	14100	15300	17600	RMT 84.45 RM 68.38	8425 5615	11010 7340
Rook/ACSS	636	24x0.1628	7x0.1085	0.5643	0.4996	0.977	818	599	219	73.22	26.78	17300	19000	21900	RMT 84.45 RM 68.38	9815 6545	12000 8000

(1) Code words shown denote ACSS with regular-strength Class A zinc-5% aluminum mischmetal alloy-coated steel core (MA2). See the Options section to find the appropriate code word modifier designation for alternative design options.

(2) Due to rounding, total values may be slightly greater or slightly less than the sum of the component values.

(3) Weights shown are for conductor only and do not include the reel. Normal length and shipping tolerances apply.

Dimensions and weights not designated minimum or maximum are nominal values and subject to manufacturing tolerances. In this context, weight means mass.

TransPowr® ACSS Bare Overhead Conductor

Aluminum Conductor Steel-Supported Concentric-Lay-Stranded

ACSS, CONCENTRIC-LAY-STRANDED (ELECTRICAL PROPERTIES)

CODE WORD (1)	SIZE AWG OR kcmil	STRANDING NO. X DIA. INCHES		CROSS-SECTION SQ. INCHES		O.D. INCHES	RESISTANCE (4) OHMS/1000 FT				AMPACITY (5)		GEOMETRIC MEAN RADIUS FT	INDUCTIVE REACTANCE OHM/1000 FT (6)	CAPACITIVE REACTANCE MEGAOHM 1000 FT (6)
		AL	STEEL	TOTAL	AL		DC @ 20°C	AC @ 25°C	AC @ 75°C	AC @ 200°C	75°C	200°C			
Spoonbill/ACSS	266.8	22x0.1101	7x0.0612	0.2300	0.2095	0.624	0.0624	0.0639	0.0768	0.1091	455	800	0.0206	0.0892	0.5716
Scaup/ACSS	266.8	24x0.1054	7x0.0703	0.2366	0.2095	0.633	0.0622	0.0636	0.0765	0.1086	460	805	0.0211	0.0887	0.5694
Partridge/ACSS	266.8	26x0.1013	7x0.0788	0.2437	0.2096	0.642	0.0619	0.0633	0.0761	0.1081	460	810	0.0216	0.0882	0.5672
Junco/ACSS	266.8	30x0.0943	7x0.0943	0.2584	0.2095	0.660	0.0615	0.0629	0.0756	0.1073	465	825	0.0226	0.0871	0.5628
Ostrich/ACSS	300	26x0.1074	7x0.0835	0.2739	0.2355	0.680	0.0551	0.0563	0.0677	0.0962	500	875	0.0229	0.0868	0.5581
Trogon/ACSS	336.4	20x0.1297	7x0.0576	0.2825	0.2642	0.692	0.0497	0.0509	0.0612	0.0869	525	925	0.0226	0.0871	0.5555
Woodcock/ACSS	336.4	22x0.1237	7x0.0687	0.2903	0.2644	0.701	0.0495	0.0507	0.0609	0.0866	530	935	0.0231	0.0866	0.5534
Widgeon/ACSS	336.4	24x0.1184	7x0.0789	0.2985	0.2642	0.710	0.0493	0.0505	0.0607	0.0862	530	940	0.0237	0.0860	0.5513
Linnet/ACSS	336.4	26x0.1137	7x0.0884	0.3070	0.2640	0.720	0.0491	0.0503	0.0604	0.0858	535	945	0.0242	0.0855	0.5491
Oriole/ACSS	336.4	30x0.1059	7x0.1059	0.3259	0.2642	0.741	0.0488	0.0499	0.0600	0.0851	540	955	0.0253	0.0845	0.5446
Ptarmigan/ACSS	397.5	20x0.1410	7x0.0627	0.3339	0.3123	0.752	0.0421	0.0431	0.0518	0.0736	585	1035	0.0245	0.0852	0.5424
Stork/ACSS	397.5	22x0.1344	7x0.0747	0.3428	0.3121	0.762	0.0419	0.0430	0.0516	0.0733	585	1040	0.0251	0.0847	0.5404
Brant/ACSS	397.5	24x0.1287	7x0.0858	0.3527	0.3122	0.772	0.0417	0.0428	0.0514	0.0730	590	1045	0.0257	0.0841	0.5382
Ibis/ACSS	397.5	26x0.1236	7x0.0961	0.3627	0.3120	0.783	0.0416	0.0426	0.0512	0.0726	595	1055	0.0263	0.0836	0.5360
Lark/ACSS	397.5	30x0.1151	7x0.1151	0.3850	0.3121	0.806	0.0413	0.0423	0.0508	0.0721	600	1070	0.0275	0.0826	0.5316
Tailorbird/ACSS	477	20x0.1544	7x0.0686	0.4003	0.3746	0.824	0.0351	0.0360	0.0433	0.0614	655	1165	0.0269	0.0831	0.5281
Toucan/ACSS	477	22x0.1472	7x0.0818	0.4112	0.3744	0.834	0.0349	0.0359	0.0431	0.0611	660	1175	0.0275	0.0826	0.5261
Flicker/ACSS	477	24x0.1410	7x0.0940	0.4233	0.3747	0.846	0.0348	0.0357	0.0429	0.0608	660	1180	0.0282	0.0820	0.5240
Hawk/ACSS	477	26x0.1354	7x0.1053	0.4353	0.3744	0.858	0.0346	0.0355	0.0427	0.0605	665	1190	0.0288	0.0815	0.5218
Hen/ACSS	477	30x0.1261	7x0.1261	0.4621	0.3747	0.883	0.0344	0.0353	0.0423	0.0601	675	1205	0.0302	0.0805	0.5173
Heron/ACSS	500	30x0.1291	7x0.1291	0.4843	0.3927	0.904	0.0328	0.0337	0.0404	0.0573	695	1240	0.0309	0.0799	0.5136
Tody/ACSS	556.5	20x0.1668	7x0.0741	0.4672	0.4370	0.890	0.0301	0.0309	0.0371	0.0527	720	1290	0.0290	0.0813	0.5161
Sapsucker/ACSS	556.5	22x0.1590	7x0.0883	0.4797	0.4368	0.901	0.0299	0.0308	0.0370	0.0524	725	1295	0.0297	0.0808	0.5140
Parakeet/ACSS	556.5	24x0.1523	7x0.1015	0.4939	0.4372	0.914	0.0298	0.0306	0.0368	0.0522	730	1305	0.0304	0.0803	0.5119
Dove/ACSS	556.5	26x0.1463	7x0.1138	0.5083	0.4371	0.927	0.0297	0.0305	0.0366	0.0519	735	1315	0.0311	0.0797	0.5097
Eagle/ACSS	556.5	30x0.1362	7x0.1362	0.5391	0.4371	0.953	0.0295	0.0303	0.0363	0.0515	740	1330	0.0326	0.0787	0.5052
Peacock/ACSS	605	24x0.1588	7x0.1059	0.5370	0.4753	0.953	0.0274	0.0282	0.0339	0.0480	770	1380	0.0317	0.0793	0.5053
Squab/ACSS	605	26x0.1525	7x0.1186	0.5522	0.4749	0.966	0.0273	0.0281	0.0337	0.0478	775	1390	0.0325	0.0788	0.5031
Wood Duck/ACSS	605	30x0.1420	7x0.1420	0.5860	0.4751	0.994	0.0271	0.0279	0.0334	0.0474	780	1405	0.0340	0.0777	0.4987
Teal/ACSS	605	30x0.1420	19x0.0852	0.5834	0.4751	0.994	0.0272	0.0279	0.0335	0.0474	780	1405	0.0340	0.0777	0.4987
Turacos/ACSS	636	20x0.1783	7x0.0792	0.5339	0.4994	0.951	0.0263	0.0271	0.0325	0.0461	785	1405	0.0310	0.0798	0.5056
Goldfinch/ACSS	636	22x0.1700	7x0.0944	0.5483	0.4994	0.963	0.0262	0.0270	0.0324	0.0459	790	1415	0.0318	0.0793	0.5036
Rook/ACSS	636	24x0.1628	7x0.1085	0.5643	0.4996	0.977	0.0261	0.0269	0.0322	0.0457	790	1425	0.0325	0.0787	0.5014

(1) Code words shown denote ACSS with regular-strength Class A zinc-5% aluminum mischmetal alloy-coated steel core (MA2). See the Options section to find the appropriate code word modifier designation for alternative design options.
 (4) Based on a conductivity of 61.2% (minimum lot average) IACS at 20°C for aluminum and 8% IACS at 20°C for the steel core. AC resistance for single-layer and three-layer designs approximates the effects of core magnetization. To convert to ohms/mile, multiply by 5.28. To convert to ohms/km, multiply by 3.281.
 (5) Based on the given conductor temperature at 60 Hz and the following conditions: 25°C ambient temperature, 2 ft/sec crosswind (90° to conductor), 0.5 coefficient of emissivity, 0.5 coefficient of absorptivity, 30° northern latitude, sea level elevation, 90° azimuth of line (East-West), clear atmosphere, and a date and time of noon on July 1 (resulting in 96.0 W/ft² of solar and sky radiated heat). Actual ampacity will differ based on local conditions. For specific ampacities, please contact your General Cable sales representative.
 (6) Values for inductive reactance and capacitive reactance are expressed in terms of a 1 ft radius.



TransPowr® ACSS Bare Overhead Conductor

Aluminum Conductor Steel-Supported Concentric-Lay-Stranded

ACSS, CONCENTRIC-LAY-STRANDED (MECHANICAL PROPERTIES)

CODE WORD (1)	SIZE AWG OR kcmil	STRANDING NO. X DIA. INCHES		CROSS-SECTION SQ. INCHES		O.D. INCHES	APPROX. WEIGHT LB/1000 FT (2)			PERCENT BY MASS		RATED STRENGTH LBS			STANDARD PACKAGES (3)		
		AL	STEEL	TOTAL	AL		TOTAL	AL	STEEL	AL	STEEL	MA2	MA3	MA5	REEL DESIGNATION	WEIGHT LBS	LENGTH FEET
Grosbeak/ACSS	636	26x0.1564	7x0.1216	0.5808	0.4995	0.990	874	599	275	68.52	31.48	20700	22400	26000	RMT 90.45 RMT 84.36 RM 68.38	11370 7580 3790	13010 8670 4335
Scoter/ACSS	636	30x0.1456	7x0.1456	0.6160	0.4995	1.019	995	601	395	60.35	39.65	27400	29700	35000	RMT 96.60 RM 68.38	14945 4980	15020 5005
Egret/ACSS	636	30x0.1456	19x0.0874	0.6135	0.4995	1.019	987	601	387	60.83	39.17	28000	30900	36600	RMT 96.60 RMT 84.45 RM 68.38	14765 9850 4925	14960 9980 4990
Flamingo/ACSS	666.6	24x0.1667	7x0.1111	0.5917	0.5238	1.000	858	628	230	73.21	26.79	18200	19900	22900	RMT 84.45 RMT 84.36 RM 68.38	9835 6545 3275	11460 7630 3815
Gannet/ACSS	666.6	26x0.1601	7x0.1245	0.6086	0.5234	1.014	916	628	289	68.52	31.48	21700	23400	27300	RMT 90.45 RMT 84.36 RM 68.38	11380 7595 3795	12410 8280 4140
Stilt/ACSS	715.5	24x0.1727	7x0.1151	0.6350	0.5622	1.036	921	674	247	73.21	26.79	19500	21300	24600	RMT 84.45 RMT 84.36 RM 68.38	9820 6540 3270	10660 7100 3550
Starling/ACSS	715.5	26x0.1659	7x0.1290	0.6535	0.5620	1.051	984	674	310	68.51	31.49	23300	25200	29300	RMT 90.45 RMT 84.36 RM 68.38	11365 7585 3795	11550 7710 3855
Redwing/ACSS	715.5	30x0.1544	19x0.0926	0.6897	0.5617	1.081	1110	676	434	60.88	39.12	30800	34000	39800	RMT 96.60 RMT 84.45 RM 68.38	14750 9850 4925	13300 8880 4440
Macaw/ACSS	795	42x0.1376	7x0.0764	0.6567	0.6246	1.055	857	749	109	87.33	12.67	11800	12600	14200	RMT 90.45 RM 68.38	9610 4805	11200 5600
Turbit/ACSS	795	20x0.1994	7x0.0886	0.6677	0.6246	1.063	895	749	146	83.67	16.33	14200	15200	17400	RMT 84.36 RM 68.38	7160 4770	8000 5330
Tern/ACSS	795	45x0.1329	7x0.0886	0.6674	0.6242	1.063	895	749	146	83.67	16.33	14200	15200	17400	RMT 96.60 RMT 90.45 RM 68.38	16110 10740 5370	18000 12000 6000
Puffin/ACSS	795	22x0.1901	7x0.1056	0.6857	0.6244	1.077	956	749	208	78.30	21.70	17700	19200	22000	RMT 84.45 RMT 84.36 RM 68.38	8420 5620 2810	8800 5870 2935
Cuckoo/ACSS	795	24x0.1820	7x0.1213	0.7053	0.6244	1.092	1023	749	274	73.22	26.78	21700	23300	26900	RMT 84.45 RMT 84.36 RM 68.38	9830 6545 3275	9610 6400 3200
Condor/ACSS	795	54x0.1213	7x0.1213	0.7049	0.6240	1.092	1023	749	274	73.22	26.78	21700	23300	26900	RMT 96.60 RMT 90.45	19130 11040	18720 10800
Drake/ACSS	795	26x0.1749	7x0.1360	0.7263	0.6246	1.107	1093	749	344	68.50	31.50	25900	28000	32600	RMT 90.45 RMT 84.36 RM 68.38	11365 7585 3795	10400 6940 3470
Mallard/ACSS	795	30x0.1628	19x0.0977	0.7669	0.6245	1.140	1234	751	483	60.84	39.16	34300	37900	44300	RMT 96.60 RMT 84.45 RM 68.38	14770 9845 4925	11970 7980 3990
Ruddy/ACSS	900	45x0.1414	7x0.0943	0.7555	0.7066	1.131	1013	848	166	83.66	16.34	15800	17000	19200	RMT 96.60 RMT 90.45 RM 68.38	16095 10730 5365	15890 10590 5295
Canary/ACSS	900	54x0.1291	7x0.1291	0.7985	0.7069	1.162	1158	848	310	73.21	26.79	24600	26400	30500	RMT 96.60 RMT 90.45	19155 11045	16540 9540
Phoenix/ACSS	954	42x0.1507	7x0.0837	0.7877	0.7491	1.155	1029	899	130	87.33	12.67	14200	15200	17100	RMT 90.45 RM 68.38	9600 4800	9340 4670
Corncrake/ACSS	954	20x0.2184	7x0.0971	0.8011	0.7492	1.165	1074	899	175	83.66	16.34	16700	18000	20400	RMT 84.36 RM 68.38	7170 4785	6670 4450

(1) Code words shown denote ACSS with regular-strength Class A zinc-5% aluminum mischmetal alloy-coated steel core (MA2). See the Options section to find the appropriate code word modifier designation for alternative design options.

(2) Due to rounding, total values may be slightly greater or slightly less than the sum of the component values.

(3) Weights shown are for conductor only and do not include the reel. Normal length and shipping tolerances apply.

Dimensions and weights not designated minimum or maximum are nominal values and subject to manufacturing tolerances. In this context, weight means mass.

TransPowr® ACSS Bare Overhead Conductor

Aluminum Conductor Steel-Supported Concentric-Lay-Stranded

ACSS, CONCENTRIC-LAY-STRANDED (ELECTRICAL PROPERTIES)

CODE WORD (1)	SIZE AWG OR kcmil	STRANDING NO. X DIA. INCHES		CROSS-SECTION SQ. INCHES		O.D. INCHES	RESISTANCE (4) OHMS/1000 FT				AMPACITY (5)		GEOMETRIC MEAN RADIUS FT	INDUCTIVE REACTANCE OHM/1000 FT (6)	CAPACITIVE REACTANCE MEGAOHM 1000 FT (6)
		AL	STEEL	TOTAL	AL		DC @ 20°C	AC @ 25°C	AC @ 75°C	AC @ 200°C	75°C	200°C			
Grosbeak/ACSS	636	26x0.1564	7x0.1216	0.5808	0.4995	0.990	0.0260	0.0267	0.0321	0.0455	795	1435	0.0333	0.0782	0.4992
Scoter/ACSS	636	30x0.1456	7x0.1456	0.6160	0.4995	1.019	0.0258	0.0265	0.0318	0.0451	805	1455	0.0348	0.0772	0.4948
Egret/ACSS	636	30x0.1456	19x0.0874	0.6135	0.4995	1.019	0.0258	0.0265	0.0318	0.0451	805	1455	0.0348	0.0772	0.4947
Flamingo/ACSS	666.6	24x0.1667	7x0.1111	0.5917	0.5238	1.000	0.0249	0.0257	0.0308	0.0436	815	1470	0.0333	0.0782	0.4977
Gannet/ACSS	666.6	26x0.1601	7x0.1245	0.6086	0.5234	1.014	0.0248	0.0255	0.0306	0.0434	820	1480	0.0341	0.0777	0.4956
Stilt/ACSS	715.5	24x0.1727	7x0.1151	0.6350	0.5622	1.036	0.0232	0.0239	0.0287	0.0406	855	1540	0.0345	0.0774	0.4922
Starling/ACSS	715.5	26x0.1659	7x0.1290	0.6535	0.5620	1.051	0.0231	0.0238	0.0286	0.0404	860	1550	0.0353	0.0768	0.4900
Redwing/ACSS	715.5	30x0.1544	19x0.0926	0.6897	0.5617	1.081	0.0230	0.0236	0.0283	0.0401	870	1570	0.0369	0.0758	0.4856
Macaw/ACSS	795	42x0.1376	7x0.0764	0.6567	0.6246	1.055	0.0211	0.0221	0.0273	0.0396	880	1570	0.0346	0.0773	0.4894
Turbit/ACSS	795	20x0.1994	7x0.0886	0.6677	0.6246	1.063	0.0210	0.0218	0.0261	0.0370	900	1630	0.0347	0.0772	0.4881
Tern/ACSS	795	45x0.1329	7x0.0886	0.6674	0.6242	1.063	0.0210	0.0220	0.0272	0.0395	880	1575	0.0351	0.0770	0.4881
Puffin/ACSS	795	22x0.1901	7x0.1056	0.6857	0.6244	1.077	0.0210	0.0217	0.0260	0.0368	905	1640	0.0355	0.0767	0.4861
Cuckoo/ACSS	795	24x0.1820	7x0.1213	0.7053	0.6244	1.092	0.0209	0.0216	0.0259	0.0366	910	1650	0.0364	0.0762	0.4840
Condor/ACSS	795	54x0.1213	7x0.1213	0.7049	0.6240	1.092	0.0209	0.0217	0.0270	0.0392	890	1595	0.0366	0.0760	0.4840
Drake/ACSS	795	26x0.1749	7x0.1360	0.7263	0.6246	1.107	0.0208	0.0215	0.0257	0.0364	915	1660	0.0372	0.0756	0.4818
Mallard/ACSS	795	30x0.1628	19x0.0977	0.7669	0.6245	1.140	0.0207	0.0213	0.0255	0.0362	925	1685	0.0389	0.0746	0.4773
Ruddy/ACSS	900	45x0.1414	7x0.0943	0.7555	0.7066	1.131	0.0186	0.0195	0.0241	0.0349	955	1710	0.0373	0.0756	0.4784
Canary/ACSS	900	54x0.1291	7x0.1291	0.7985	0.7069	1.162	0.0184	0.0193	0.0239	0.0346	965	1730	0.0390	0.0746	0.4742
Phoenix/ACSS	954	42x0.1507	7x0.0837	0.7877	0.7491	1.155	0.0176	0.0185	0.0228	0.0330	985	1770	0.0379	0.0752	0.4751
Corncrake/ACSS	954	20x0.2184	7x0.0971	0.8011	0.7492	1.165	0.0175	0.0183	0.0219	0.0309	1005	1835	0.0380	0.0751	0.4738

(1) Code words shown denote ACSS with regular-strength Class A zinc-5% aluminum mischmetal alloy-coated steel core (MA2). See the Options section to find the appropriate code word modifier designation for alternative design options.
 (4) Based on a conductivity of 61.2% (minimum lot average) IACS at 20°C for aluminum and 8% IACS at 20°C for the steel core. AC resistance for single-layer and three-layer designs approximates the effects of core magnetization. To convert to ohms/mile, multiply by 5.28. To convert to ohms/km, multiply by 3.281.
 (5) Based on the given conductor temperature at 60 Hz and the following conditions: 25°C ambient temperature, 2 ft/sec crosswind (90° to conductor), 0.5 coefficient of emissivity, 0.5 coefficient of absorptivity, 30° northern latitude, sea level elevation, 90° azimuth of line (East-West), clear atmosphere, and a date and time of noon on July 1 (resulting in 96.0 W/ft² of solar and sky radiated heat). Actual ampacity will differ based on local conditions. For specific ampacities, please contact your General Cable sales representative.
 (6) Values for inductive reactance and capacitive reactance are expressed in terms of a 1 ft radius.



TransPowr® ACSS Bare Overhead Conductor

Aluminum Conductor Steel-Supported Concentric-Lay-Stranded

ACSS, CONCENTRIC-LAY-STRANDED (MECHANICAL PROPERTIES)

CODE WORD (1)	SIZE AWG OR kcmil	STRANDING NO. X DIA. INCHES		CROSS-SECTION SQ. INCHES		O.D. INCHES	APPROX. WEIGHT LB/1000 FT (2)			PERCENT BY MASS		RATED STRENGTH LBS			STANDARD PACKAGES (3)		
		AL	STEEL	TOTAL	AL		TOTAL	AL	STEEL	AL	STEEL	MA2	MA3	MA5	REEL DESIGNATION	WEIGHT LBS	LENGTH FEET
Rail/ACSS	954	45x0.1456	7x0.0971	0.8011	0.7492	1.165	1074	899	175	83.66	16.34	16700	18000	20400	RMT 96.60 RMT 90.45 RM 68.38	16125 10750 5375	15000 10000 5000
Towhee/ACSS	954	48x0.1410	7x0.1097	0.8157	0.7495	1.175	1123	899	224	80.05	19.95	19700	21300	24300	RMT 96.60 RMT 90.45 RMT 84.36	17970 11980 5990	16000 10670 5335
Redbird/ACSS	954	24x0.1994	7x0.1329	0.8466	0.7495	1.196	1227	899	329	73.21	26.79	26000	28000	32300	RMT 84.45 RMT 84.36	9825 6545	8000 5330
Cardinal/ACSS	954	54x0.1329	7x0.1329	0.8462	0.7491	1.196	1227	899	329	73.21	26.79	26000	28000	32300	RMT 96.60 RMT 90.45	19140 11780	15600 9600
Canvasback/ACSS	954	30x0.1783	19x0.1070	0.9201	0.7493	1.248	1480	901	580	60.85	39.15	41100	45400	53100	RMT 96.60 RMT 84.45 RM 68.38	14780 9865 4930	9980 6660 3330
Snowbird/ACSS	1033.5	42x0.1569	7x0.0872	0.8539	0.8121	1.203	1115	973	142	87.31	12.69	15400	16400	18500	RMT 90.45 RM 68.38	9610 4805	8610 4305
Ortolan/ACSS	1033.5	45x0.1515	7x0.1010	0.8681	0.8121	1.212	1163	973	190	83.68	16.32	18100	19500	22000	RMT 96.60 RMT 90.45 RM 68.38	16110 10735 5365	13850 9230 4615
Whooper/ACSS	1033.5	48x0.1467	7x0.1141	0.8829	0.8113	1.223	1216	973	242	80.07	19.93	21300	23100	26300	RMT 96.60 RMT 90.45 RM 68.38	17945 11970 5985	14770 9850 4925
Curlew/ACSS	1033.5	54x0.1383	7x0.1383	0.9164	0.8112	1.245	1329	973	356	73.22	26.78	28200	30300	35000	RMT 96.60 RMT 90.45	19140 11045	14400 8310
Avocet/ACSS	1113	42x0.1628	7x0.0904	0.9192	0.8743	1.248	1200	1048	152	87.33	12.67	16300	17500	19500	RMT 96.60 RMT 90.45 RM 68.38	14400 9600 4800	12000 8000 4000
Bluejay/ACSS	1113	45x0.1573	7x0.1049	0.9350	0.8745	1.259	1253	1048	205	83.66	16.34	19500	21000	23800	RMT 96.60 RMT 90.45 RM 68.38	16120 10745 1610	12853 8570 1285
Bullfinch/ACSS	1113	48x0.1523	7x0.1184	0.9516	0.8744	1.269	1310	1048	261	80.04	19.96	23000	24900	28400	RMT 96.60 RMT 90.45 RMT 84.36	17945 11975 5985	13700 9140 4570
Finch/ACSS	1113	54x0.1436	19x0.0861	0.9854	0.8746	1.293	1430	1053	376	73.69	26.31	30400	33200	38700	RMT 96.60 RMT 90.45	19035 10970	13310 7670
Oxbird/ACSS	1192.5	42x0.1685	7x0.0936	0.9847	0.9365	1.292	1286	1123	163	87.32	12.68	17500	18700	20900	RMT 96.60 RMT 90.45 RM 68.38	14405 9605 4805	11200 7470 3735
Bunting/ACSS	1192.5	45x0.1628	7x0.1085	1.0014	0.9367	1.302	1342	1123	219	83.68	16.32	20900	22500	25400	RMT 96.60 RMT 90.45 RM 68.38	16105 10735 5370	12000 8000 4000
Cormorant/ACSS	1192.5	48x0.1576	7x0.1226	1.0190	0.9364	1.313	1403	1123	280	80.06	19.94	24600	26200	30000	RMT 96.60 RMT 90.45 RMT 84.36	17960 11970 5985	12800 8530 4265
Grackle/ACSS	1192.5	54x0.1486	19x0.0892	1.0553	0.9365	1.338	1531	1129	403	73.70	26.30	32600	35500	41500	RMT 96.60 RMT 90.45	19025 10970	12420 7160
Scissortail/ACSS	1272	42x0.1740	7x0.0967	1.0501	0.9987	1.334	1372	1198	174	87.32	12.68	18700	20000	22300	RMT 96.60 RMT 90.45 RM 68.38	14405 9605 4800	10500 7000 3500
Bittern/ACSS	1272	45x0.1681	7x0.1121	1.0678	0.9987	1.345	1432	1198	234	83.67	16.33	22300	24000	27100	RMT 96.60 RMT 90.45 RM 68.38	16110 10740 5370	11250 7500 3750

(1) Code words shown denote ACSS with regular-strength Class A zinc-5% aluminum mischmetal alloy-coated steel core (MA2). See the Options section to find the appropriate code word modifier designation for alternative design options.

(2) Due to rounding, total values may be slightly greater or slightly less than the sum of the component values.

(3) Weights shown are for conductor only and do not include the reel. Normal length and shipping tolerances apply.

Dimensions and weights not designated minimum or maximum are nominal values and subject to manufacturing tolerances. In this context, weight means mass.

TransPowr® ACSS Bare Overhead Conductor

Aluminum Conductor Steel-Supported Concentric-Lay-Stranded

ACSS, CONCENTRIC-LAY-STRANDED (ELECTRICAL PROPERTIES)

CODE WORD (1)	SIZE AWG OR kcmil	STRANDING NO. X DIA. INCHES		CROSS-SECTION SQ. INCHES		O.D. INCHES	RESISTANCE (4) OHMS/1000 FT				AMPACITY (5)		GEOMETRIC MEAN RADIUS FT	INDUCTIVE REACTANCE OHM/1000 FT (6)	CAPACITIVE REACTANCE MEGAOHM 1000 FT (6)
		AL	STEEL	TOTAL	AL		DC @ 20°C	AC @ 25°C	AC @ 75°C	AC @ 200°C	75°C	200°C			
Rail/ACSS	954	45x0.1456	7x0.0971	0.8011	0.7492	1.165	0.0175	0.0185	0.0228	0.0329	990	1775	0.0384	0.0749	0.4738
Towhee/ACSS	954	48x0.1410	7x0.1097	0.8157	0.7495	1.175	0.0175	0.0184	0.0227	0.0328	990	1785	0.0390	0.0746	0.4725
Redbird/ACSS	954	24x0.1994	7x0.1329	0.8466	0.7495	1.196	0.0174	0.0181	0.0217	0.0306	1020	1860	0.0398	0.0741	0.4697
Cardinal/ACSS	954	54x0.1329	7x0.1329	0.8462	0.7491	1.196	0.0174	0.0182	0.0225	0.0326	1000	1800	0.0401	0.0739	0.4697
Canvasback/ACSS	954	30x0.1783	19x0.1070	0.9201	0.7493	1.248	0.0172	0.0178	0.0214	0.0302	1040	1900	0.0427	0.0725	0.4630
Snowbird/ACSS	1033.5	42x0.1569	7x0.0872	0.8539	0.8121	1.203	0.0162	0.0172	0.0211	0.0305	1035	1865	0.0394	0.0743	0.4688
Ortolan/ACSS	1033.5	45x0.1515	7x0.1010	0.8681	0.8121	1.212	0.0162	0.0171	0.0211	0.0304	1040	1875	0.0400	0.0740	0.4676
Whooper/ACSS	1033.5	48x0.1467	7x0.1141	0.8829	0.8113	1.223	0.0161	0.0170	0.0210	0.0303	1040	1880	0.0406	0.0737	0.4662
Curlew/ACSS	1033.5	54x0.1383	7x0.1383	0.9164	0.8112	1.245	0.0161	0.0169	0.0208	0.0301	1050	1900	0.0418	0.0730	0.4634
Avocet/ACSS	1113	42x0.1628	7x0.0904	0.9192	0.8743	1.248	0.0151	0.0160	0.0197	0.0283	1080	1960	0.0409	0.0735	0.4630
Bluejay/ACSS	1113	45x0.1573	7x0.1049	0.9350	0.8745	1.259	0.0150	0.0159	0.0196	0.0282	1085	1970	0.0415	0.0731	0.4618
Bullfinch/ACSS	1113	48x0.1523	7x0.1184	0.9516	0.8744	1.269	0.0150	0.0159	0.0195	0.0281	1090	1975	0.0421	0.0728	0.4604
Finch/ACSS	1113	54x0.1436	19x0.0861	0.9854	0.8746	1.293	0.0150	0.0158	0.0195	0.0281	1100	1990	0.0434	0.0721	0.4576
Oxbird/ACSS	1192.5	42x0.1685	7x0.0936	0.9847	0.9365	1.292	0.0141	0.0150	0.0184	0.0264	1130	2050	0.0423	0.0727	0.4576
Bunting/ACSS	1192.5	45x0.1628	7x0.1085	1.0014	0.9367	1.302	0.0140	0.0150	0.0183	0.0263	1135	2060	0.0429	0.0723	0.4564
Cormorant/ACSS	1192.5	48x0.1576	7x0.1226	1.0190	0.9364	1.313	0.0140	0.0149	0.0183	0.0263	1140	2070	0.0436	0.0720	0.4550
Grackle/ACSS	1192.5	54x0.1486	19x0.0892	1.0553	0.9365	1.338	0.0140	0.0148	0.0182	0.0262	1145	2085	0.0449	0.0713	0.4522
Scissortail/ACSS	1272	42x0.1740	7x0.0967	1.0501	0.9987	1.334	0.0132	0.0142	0.0173	0.0248	1175	2140	0.0437	0.0719	0.4526
Bittern/ACSS	1272	45x0.1681	7x0.1121	1.0678	0.9987	1.345	0.0131	0.0141	0.0172	0.0247	1180	2150	0.0443	0.0716	0.4513

(1) Code words shown denote ACSS with regular-strength Class A zinc-5% aluminum mischmetal alloy-coated steel core (MA2). See the Options section to find the appropriate code word modifier designation for alternative design options.
 (4) Based on a conductivity of 61.2% (minimum lot average) IACS at 20°C for aluminum and 8% IACS at 20°C for the steel core. AC resistance for single-layer and three-layer designs approximates the effects of core magnetization. To convert to ohms/mile, multiply by 5.28. To convert to ohms/km, multiply by 3.281.
 (5) Based on the given conductor temperature at 60 Hz and the following conditions: 25°C ambient temperature, 2 ft/sec crosswind (90° to conductor), 0.5 coefficient of emissivity, 0.5 coefficient of absorptivity, 30° northern latitude, sea level elevation, 90° azimuth of line (East-West), clear atmosphere, and a date and time of noon on July 1 (resulting in 96.0 W/ft² of solar and sky radiated heat). Actual ampacity will differ based on local conditions. For specific ampacities, please contact your General Cable sales representative.
 (6) Values for inductive reactance and capacitive reactance are expressed in terms of a 1 ft radius.



TransPowr® ACSS Bare Overhead Conductor

Aluminum Conductor Steel-Supported Concentric-Lay-Stranded

ACSS, CONCENTRIC-LAY-STRANDED (MECHANICAL PROPERTIES)

CODE WORD (1)	SIZE AWG OR kcmil	STRANDING NO. X DIA. INCHES		CROSS-SECTION SQ. INCHES		O.D. INCHES	APPROX. WEIGHT LB/1000 FT (2)			PERCENT BY MASS		RATED STRENGTH LBS			STANDARD PACKAGES (3)		
		AL	STEEL	TOTAL	AL		TOTAL	AL	STEEL	AL	STEEL	MA2	MA3	MA5	REEL DESIGNATION	WEIGHT LBS	LENGTH FEET
Diver/ACSS	1272	48x0.1628	7x0.1266	1.0873	0.9992	1.357	1496	1198	298	80.06	19.94	26200	28000	31900	RMT 96.60 RMT 90.45 RMT 84.36	17950 11970 5985	12000 8000 4000
Pheasant/ACSS	1272	54x0.1535	19x0.0921	1.1259	0.9993	1.381	1633	1204	429	73.71	26.29	34100	37300	43000	RMT 96.60 RMT 90.45	19025 10975	11650 6720
Ringdove/ACSS	1351.5	42x0.1794	7x0.0997	1.1163	1.0617	1.376	1458	1273	185	87.31	12.69	19900	21200	23700	RMT 96.60 RMT 90.45 RM 68.38	14435 9630 4815	9880 6590 3295
Dipper/ACSS	1351.5	45x0.1733	7x0.1155	1.1348	1.0614	1.386	1521	1273	248	83.68	16.32	23700	25500	28800	RMT 96.60 RMT 90.45 RM 68.38	16140 10760 5380	10590 7060 3530
-none-	1351.5	48x0.1678	7x0.1305	1.1551	1.0614	1.398	1590	1273	317	80.06	19.94	27900	29700	33900	RMT 96.60 RMT 90.45 RMT 84.36	17985 11995 6000	11290 7530 3765
Martin/ACSS	1351.5	54x0.1582	19x0.0949	1.1958	1.0614	1.424	1735	1279	456	73.72	26.28	36200	39600	45600	RMT 96.60 RMT 90.45	19015 10965	10960 6320
Popinjay/ACSS	1431	42x0.1846	7x0.1026	1.1820	1.1241	1.415	1544	1348	196	87.31	12.69	21000	22500	25100	RMT 96.60 RMT 90.45 RM 68.38	14435 9620 4810	9330 6220 3110
Bobolink/ACSS	1431	45x0.1783	7x0.1189	1.2013	1.1236	1.426	1611	1348	263	83.67	16.33	25100	27000	30500	RMT 96.60 RMT 90.45 RM 68.38	16140 10755 5385	10000 6665 3335
Wagtail/ACSS	1431	48x0.1727	7x0.1343	1.2235	1.1244	1.439	1684	1348	336	80.06	19.94	29500	31500	35900	RMT 96.60 RMT 90.45 RMT 84.36	17995 12000 6000	10660 7110 3555
Plover/ACSS	1431	54x0.1628	19x0.0977	1.2665	1.1241	1.465	1838	1354	483	73.71	26.29	38400	41900	48300	RMT 96.60 RMT 90.45	19025 10975	10350 5970
Nuthatch/ACSS	1510.5	45x0.1832	7x0.1221	1.2682	1.1862	1.466	1700	1423	277	83.68	16.32	26500	28100	31800	RMT 96.60 RMT 90.45 RM 68.38	16115 10745 5370	9480 6320 3160
Parrot/ACSS	1510.5	54x0.1672	19x0.1003	1.3358	1.1856	1.505	1939	1430	509	73.74	26.26	40500	44200	51000	RMT 96.60 RMT 90.45	18990 10950	9800 5650
Ratite/ACSS	1590	42x0.1946	7x0.1081	1.3134	1.2492	1.492	1715	1498	218	87.32	12.68	23400	25000	27900	RMT 96.60 RMT 90.45 RM 68.38	14405 9605 4800	8400 5600 2800
Lapwing/ACSS	1590	45x0.1880	7x0.1253	1.3355	1.2492	1.504	1790	1498	292	83.67	16.33	27900	29600	33500	RMT 96.60 RMT 90.45 RM 68.38	16110 10740 5370	9000 6000 3000
Hornbill/ACSS	1590	48x0.1820	7x0.1416	1.3590	1.2487	1.517	1871	1498	373	80.05	19.95	32200	34400	39400	RMT 96.60 RMT 90.45 RMT 84.36	17960 11975 5985	9600 6400 3200
Falcon/ACSS	1590	54x0.1716	19x0.1030	1.4072	1.2489	1.545	2042	1505	537	73.70	26.30	42600	46600	53700	RMT 96.60 RMT 90.45	19030 10965	9320 5370
Chukar/ACSS	1780	84x0.1456	19x0.0874	1.5126	1.3986	1.602	2071	1685	387	81.33	18.67	35300	38200	43900	RMT 96.60	19060	9200
Seahawk/ACSS	1869	68x0.1658	7x0.0921	1.5148	1.4681	1.603	1918	1760	158	91.77	8.23	21500	22700	24800	RMT 96.60	17345	9000
Mockingbird/ACSS	2034.5	72x0.1681	7x0.1121	1.6670	1.5979	1.681	2160	1926	234	89.17	10.83	27200	28900	32000	RMT 96.60	16115	7460
Roadrunner/ACSS	2057.5	76x0.1645	19x0.0768	1.7033	1.6152	1.700	2246	1947	299	86.71	13.29	31700	33900	38300	RMT 96.60	17520	7800
Bluebird/ACSS	2156	84x0.1602	19x0.0961	1.8310	1.6931	1.762	2508	2041	467	81.36	18.64	42100	45500	51700	RMT 96.60	18805	7500
Kiwi/ACSS	2167	72x0.1735	7x0.1157	1.7758	1.7022	1.735	2300	2051	249	89.17	10.83	29000	30800	34100	RMT 96.60	16100	7000
Thrasher/ACSS	2312	76x0.1744	19x0.0814	1.9144	1.8155	1.802	2524	2188	335	86.71	13.29	35600	38100	43000	RMT 96.60	17660	7000
Joree/ACSS	2515	76x0.1819	19x0.0849	2.0826	1.9750	1.880	2745	2380	365	86.71	13.29	38700	41400	46800	RMT 96.60	17295	6300

(1) Code words shown denote ACSS with regular-strength Class A zinc-5% aluminum mischmetal alloy-coated steel core (MA2). See the Options section to find the appropriate code word modifier designation for alternative design options.

(2) Due to rounding, total values may be slightly greater or slightly less than the sum of the component values.

(3) Weights shown are for conductor only and do not include the reel. Normal length and shipping tolerances apply.

Dimensions and weights not designated minimum or maximum are nominal values and subject to manufacturing tolerances. In this context, weight means mass.

TransPowr® ACSS Bare Overhead Conductor

Aluminum Conductor Steel-Supported Concentric-Lay-Stranded

ACSS, CONCENTRIC-LAY-STRANDED (ELECTRICAL PROPERTIES)

CODE WORD (1)	SIZE AWG OR kcmil	STRANDING NO. X DIA. INCHES		CROSS-SECTION SQ. INCHES		O.D. INCHES	RESISTANCE (4) OHMS/1000 FT				AMPACITY (5)		GEOMETRIC MEAN RADIUS FT	INDUCTIVE REACTANCE OHM/1000 FT (6)	CAPACITIVE REACTANCE MEGAOHM 1000 FT (6)
		AL	STEEL	TOTAL	AL		DC @ 20°C	AC @ 25°C	AC @ 75°C	AC @ 200°C	75°C	200°C			
Diver/ACSS	1272	48x0.1628	7x0.1266	1.0873	0.9992	1.357	0.0131	0.0140	0.0172	0.0246	1185	2160	0.0450	0.0713	0.4500
Pheasant/ACSS	1272	54x0.1535	19x0.0921	1.1259	0.9993	1.381	0.0131	0.0139	0.0171	0.0246	1190	2175	0.0464	0.0706	0.4471
Ringdove/ACSS	1351.5	42x0.1794	7x0.0997	1.1163	1.0617	1.376	0.0124	0.0134	0.0163	0.0234	1220	2225	0.0451	0.0712	0.4478
Dipper/ACSS	1351.5	45x0.1733	7x0.1155	1.1348	1.0614	1.386	0.0124	0.0133	0.0163	0.0233	1225	2235	0.0457	0.0709	0.4466
-none-	1351.5	48x0.1678	7x0.1305	1.1551	1.0614	1.398	0.0123	0.0133	0.0162	0.0232	1230	2245	0.0464	0.0706	0.4452
Martin/ACSS	1351.5	54x0.1582	19x0.0949	1.1958	1.0614	1.424	0.0123	0.0132	0.0161	0.0231	1235	2260	0.0478	0.0699	0.4424
Popinjay/ACSS	1431	42x0.1846	7x0.1026	1.1820	1.1241	1.415	0.0117	0.0127	0.0155	0.0221	1260	2310	0.0464	0.0706	0.4434
Bobolink/ACSS	1431	45x0.1783	7x0.1189	1.2013	1.1236	1.426	0.0117	0.0127	0.0154	0.0220	1265	2320	0.0470	0.0703	0.4421
Wagtail/ACSS	1431	48x0.1727	7x0.1343	1.2235	1.1244	1.439	0.0117	0.0126	0.0153	0.0219	1270	2330	0.0477	0.0699	0.4408
Plover/ACSS	1431	54x0.1628	19x0.0977	1.2665	1.1241	1.465	0.0117	0.0125	0.0153	0.0219	1280	2350	0.0492	0.0692	0.4379
Nuthatch/ACSS	1510.5	45x0.1832	7x0.1221	1.2682	1.1862	1.466	0.0111	0.0121	0.0147	0.0209	1310	2405	0.0483	0.0696	0.4379
Parrot/ACSS	1510.5	54x0.1672	19x0.1003	1.3358	1.1856	1.505	0.0110	0.0119	0.0145	0.0207	1325	2435	0.0505	0.0686	0.4337
Ratite/ACSS	1590	42x0.1946	7x0.1081	1.3134	1.2492	1.492	0.0105	0.0116	0.0140	0.0199	1340	2475	0.0489	0.0694	0.4351
Lapwing/ACSS	1590	45x0.1880	7x0.1253	1.3355	1.2492	1.504	0.0105	0.0115	0.0140	0.0199	1350	2485	0.0496	0.0690	0.4338
Hornbill/ACSS	1590	48x0.1820	7x0.1416	1.3590	1.2487	1.517	0.0105	0.0114	0.0139	0.0198	1355	2500	0.0503	0.0687	0.4325
Falcon/ACSS	1590	54x0.1716	19x0.1030	1.4072	1.2489	1.545	0.0105	0.0114	0.0138	0.0197	1365	2520	0.0519	0.0680	0.4297
Chukar/ACSS	1780	84x0.1456	19x0.0874	1.5126	1.3986	1.602	0.0094	0.0104	0.0122	0.0169	1465	2750	0.0532	0.0674	0.4240
Seahawk/ACSS	1869	68x0.1658	7x0.0921	1.5148	1.4681	1.603	0.0090	0.0101	0.0119	0.0163	1490	2805	0.0523	0.0678	0.4239
Mockingbird/ACSS	2034.5	72x0.1681	7x0.1121	1.6670	1.5979	1.681	0.0083	0.0094	0.0110	0.0151	1565	2960	0.0551	0.0666	0.4164
Roadrunner/ACSS	2057.5	76x0.1645	19x0.0768	1.7033	1.6152	1.700	0.0082	0.0093	0.0108	0.0149	1580	2995	0.0560	0.0662	0.4146
Bluebird/ACSS	2156	84x0.1602	19x0.0961	1.8310	1.6931	1.762	0.0078	0.0088	0.0103	0.0141	1640	3105	0.0586	0.0652	0.4090
Kiwi/ACSS	2167	72x0.1735	7x0.1157	1.7758	1.7022	1.735	0.0078	0.0090	0.0104	0.0142	1620	3080	0.0569	0.0659	0.4115
Thrasher/ACSS	2312	76x0.1744	19x0.0814	1.9144	1.8155	1.802	0.0073	0.0085	0.0098	0.0134	1690	3220	0.0594	0.0649	0.4055
Joree/ACSS	2515	76x0.1819	19x0.0849	2.0826	1.9750	1.880	0.0067	0.0079	0.0092	0.0124	1765	3390	0.0619	0.0639	0.3989

(1) Code words shown denote ACSS with regular-strength Class A zinc-5% aluminum mischmetal alloy-coated steel core (MA2). See the Options section to find the appropriate code word modifier designation for alternative design options.
 (4) Based on a conductivity of 61.2% (minimum lot average) IACS at 20°C for aluminum and 8% IACS at 20°C for the steel core. AC resistance for single-layer and three-layer designs approximates the effects of core magnetization. To convert to ohms/mile, multiply by 5.28. To convert to ohms/km, multiply by 3.281.
 (5) Based on the given conductor temperature at 60 Hz and the following conditions: 25°C ambient temperature, 2 ft/sec crosswind (90° to conductor), 0.5 coefficient of emissivity, 0.5 coefficient of absorptivity, 30° northern latitude, sea level elevation, 90° azimuth of line (East-West), clear atmosphere, and a date and time of noon on July 1 (resulting in 96.0 W/ft² of solar and sky radiated heat). Actual ampacity will differ based on local conditions. For specific ampacities, please contact your General Cable sales representative.
 (6) Values for inductive reactance and capacitive reactance are expressed in terms of a 1 ft radius.



Notes

TransPowr® ACSS/TW Bare Overhead Conductor

Trapezoidal Aluminum Conductor Steel-Supported Concentric-Lay-Stranded

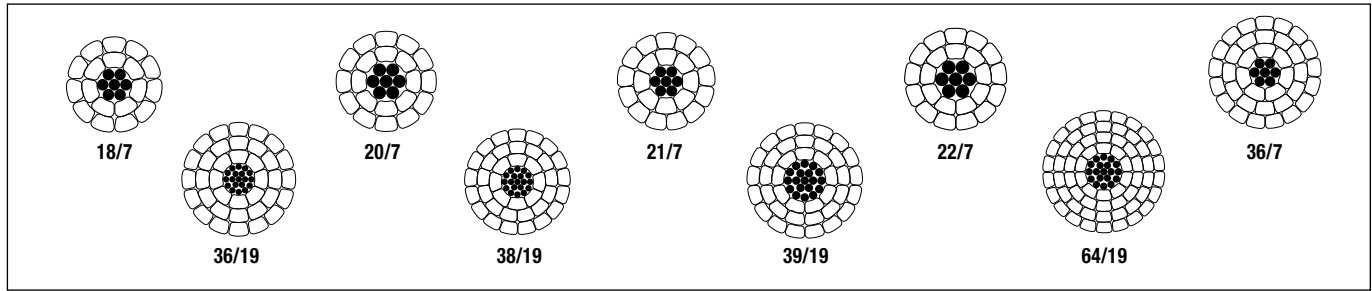

Product Construction:

Complete Conductor:

TransPowr® ACSS/TW is a trapezoidal aluminum conductor steel-supported concentric-lay-stranded conductor. The aluminum strands are trapezoidal in shape.

The wedge-shaped aluminum strands enable a more compact alignment of the aluminum wires. Conductor designs that maintain the same circular mil cross-sectional area of aluminum as a conventional round conductor result in a TW conductor that is 10 to 15 percent smaller in overall diameter. Conductor designs that maintain the same overall diameter as a conventional round conductor result in a TW conductor that has 20 to 25 percent more aluminum cross-sectional area packed in.

The ACSS/TW conductors are manufactured in accordance with the requirements of the latest issue of ASTM B857.

The steel strands form the central core of the conductor, around which is stranded two, three or four layers of aluminum 1350 O temper (annealed) wires. The steel core may consist of a concentric stranded cable of 7, 19 or more wires. Numerous combinations of aluminum and steel strands and layers are possible. The sizes and constructions listed on the following pages are common examples used in overhead lines.

Standard ACSS/TW designs are manufactured with regular-strength Class A zinc-5% aluminum mischmetal alloy-coated steel core (/MA2).

Features and Benefits:

TransPowr® ACSS/TW conductors are similar to conventional ACSR/TW conductors but have some very important additional advantages. ACSS/TW conductors can operate continuously at high temperatures (up to 250°C) without damage. ACSS sags less than ACSR/TW under emergency electrical loadings, it has self-damping properties, and its final sags are not affected by long-term creep of the aluminum.

ACSS/TW conductors constructed of equivalent aluminum circular mil cross-sectional area provide a conductor that is smaller in overall diameter than the equivalent conventional round wire ACSS conductor. The reduced conductor diameter is advantageous in reducing the effects of ice and wind loading on the conductor.

ACSS/TW conductors constructed to equivalent overall diameter enable a greater circular mil cross-sectional area of aluminum within the conductor, allowing a significant increase in conductor current-carrying capacity.

Applications:

Trapezoidal Aluminum Conductors Steel-Supported (ACSS/TW) are used for overhead transmission lines. They are especially useful in reconductoring applications requiring increased current with existing tensions and clearances; new line applications where structures can be economized due to reduced sag; new line applications requiring high emergency loadings; and lines where aeolian vibration is a problem.

Electrical Parameters:

The electrical parameters for the trapezoidal ACSS equivalent circular mil area and equivalent overall diameter conductors may be found in the last table of this section.

Options:

- High-strength Class A zinc-5% aluminum mischmetal alloy-coated steel core (/MA3 to ASTM B803)
- Extra-high-strength Class A zinc-5% aluminum mischmetal alloy-coated steel core (/MA4 to ASTM B958)
- Ultra-high-strength Class A zinc-5% aluminum mischmetal alloy-coated steel core (/MA5 to ASTM B958)
- Aluminum-clad steel core (/AW)
- 250°C operating temperature rating utilizing either the zinc-5% aluminum mischmetal alloy-coated steel core wires or the aluminum-clad steel core wires
- Non-specular surface finish (/NS)
- E3X® surface coating (/E3X)

At the present time, CAN/CSA C61089 does not recognize ACSS/TW conductor designs. The information provided on the following pages is from our US catalog.

For other conductor sizes, designs and/or specific installation requirements not shown in the tables, contact your General Cable sales representative or e-mail infoca@generalcable.com.

TransPowr® ACSS/TW Bare Overhead Conductor

Trapezoidal Aluminum Conductor Steel-Supported Concentric-Lay-Stranded

ACSS/TW (MECHANICAL PROPERTIES) – REDUCED DIAMETER - CONDUCTORS SIZED TO HAVE EQUIVALENT CIRCULAR MIL AREA TO REGULAR ACSS

CODE WORD (1)	SIZE AWG OR kcmil	TYPE	NO. AL WIRES	FILL FACTOR	EQUIVALENT AL DIA. INCHES	STEEL CORE NO. X DIA. INCHES	STEEL CORE O.D. INCHES	CROSS-SECTION SQ. INCHES			APPROX. WEIGHT LB/1000 FT (2)			PERCENT BY MASS		RATED STRENGTH LBS			STANDARD PACKAGES (3)		
								TOTAL	AL	O.D. INCHES	TOTAL	AL	STEEL	AL	STEEL	MA2	MA3	MA5	REEL DESIG.	WEIGHT LBS	LENGTH FEET
Oriole/ACSS/TW	336.4	23	17	88.7	0.1407	7x0.1059	0.3177	0.3258	0.2642	0.69	526	318	209	60.34	39.66	14800	16300	19100	RMT 84.36 NR 60.28	7743 4276	14720 8130
Flicker/ACSS/TW	477	13	18	91.3	0.1628	7x0.0940	0.2820	0.4234	0.3748	0.78	612	448	164	73.14	26.86	13000	14200	16400	RM 84.36 NR 60.28	6765 4506	11050 7360
Hawk/ACSS/TW	477	16	18	91.3	0.1628	7x0.1053	0.3159	0.4355	0.3745	0.79	655	448	206	68.47	31.53	15600	17100	19800	RMT 84.36 NR 60.28	7233 3620	11050 5530
Hen/ACSS/TW	477	23	16	88.7	0.1727	7x0.1261	0.3783	0.4620	0.3746	0.83	746	450	296	60.34	39.66	21000	22700	26700	RM 68.38 NR 60.28	7288 3648	9770 4890
Parakeet/ACSS/TW	556.5	13	18	92.0	0.1758	7x0.1015	0.3045	0.4938	0.4372	0.84	714	522	192	73.15	26.85	15200	16600	19100	RM 68.38 NR 60.28	6770 3385	9480 4740
Dove/ACSS/TW	556.5	16	20	91.8	0.1668	7x0.1138	0.3414	0.5083	0.4371	0.85	764	523	241	68.45	31.55	18200	19900	23100	RMT 84.36 NR 60.28	8036 4018	10520 5260
Rook/ACSS/TW	636	13	18	92.6	0.1880	7x0.1085	0.3255	0.5641	0.4994	0.89	816	597	219	73.15	26.85	17300	19000	21900	RM 68.38 NR 60.28	6766 3387	8290 4150
Grosbeak/ACSS/TW	636	16	20	92.0	0.1783	7x0.1216	0.3648	0.5809	0.4996	0.91	873	598	275	68.47	31.53	20700	22400	26000	RMT 84.36 NR 66.28	8030 4015	9200 4600
Tern/ACSS/TW	795	7	17	93.5	0.2163	7x0.0888	0.2664	0.6680	0.6247	0.96	892	745	147	83.54	16.46	14200	15300	17500	RM 68.38 NR 60.28	5601 2801	6280 3140
Puffin/ACSS/TW	795	11	21	93.5	0.1945	7x0.1108	0.3324	0.6916	0.6241	0.98	974	746	229	76.55	23.45	18900	20600	23700	RMT 84.36 NR 60.28	7542 3771	7740 3870
Condor/ACSS/TW	795	13	21	93.0	0.1945	7x0.1213	0.3639	0.7051	0.6242	0.99	1020	746	274	73.15	26.85	21700	23300	26900	RMT 84.36 NR 60.28	7896 3948	7740 3870
Drake/ACSS/TW	795	16	20	93.1	0.1993	7x0.1360	0.4080	0.7259	0.6242	1.01	1091	747	344	68.45	31.55	25900	28000	32500	RMT 84.36 NR 60.28	8042 4016	7370 3680
Mallard/ACSS/TW	795	23	22	93.0	0.1901	19x0.0977	0.4885	0.7668	0.6244	1.05	1234	751	483	60.84	39.16	34300	37900	44300	RMT 84.36 NR 60.28	9946 3973	8060 3220
Phoenix/ACSS/TW	954	5	30	92.9	0.1784	7x0.0837	0.2511	0.7882	0.7497	1.04	1028	898	130	87.32	12.68	14200	15200	17100	RMT 84.45 NR 66.28	9448 4729	9190 4600
Rail/ACSS/TW	954	7	33	92.2	0.1700	7x0.0971	0.2913	0.8011	0.7493	1.06	1074	899	175	83.66	16.34	16700	18000	20400	RMT 84.45 RM 68.38	10848 5424	10100 5050
Cardinal/ACSS/TW	954	13	21	93.9	0.2131	7x0.1329	0.3987	0.8463	0.7492	1.08	1224	895	329	73.15	26.85	26000	28000	32300	RMT 84.36 NR 60.28	7896 3942	6450 3220
Snowbird/ACSS/TW	1033.5	5	30	92.5	0.1856	7x0.0871	0.2613	0.8532	0.8115	1.09	1114	972	141	87.32	12.68	15400	16400	18500	RMT 84.45 RM 66.32	9455 4722	8490 4240
Ortolan/ACSS/TW	1033.5	7	33	92.3	0.1769	7x0.1010	0.3030	0.8673	0.8112	1.10	1163	973	190	83.68	16.32	18100	19500	22000	RMT 84.45 RM 68.38	10842 5421	9320 4660
Curlew/ACSS/TW	1033.5	13	21	93.7	0.2219	7x0.1383	0.4149	0.9170	0.8118	1.13	1326	970	356	73.15	26.85	28200	30300	35000	RMT 84.36 NR 60.28	7890 3952	5950 2980
Avocet/ACSS/TW	1113	5	30	93.0	0.1926	7x0.0904	0.2712	0.9186	0.8737	1.13	1199	1047	152	87.32	12.68	16300	17500	19500	RMT 84.36 RM 66.32	9439 4726	7870 3940
Bluejay/ACSS/TW	1113	7	33	92.7	0.1837	7x0.1049	0.3147	0.9351	0.8746	1.14	1253	1048	205	83.66	16.34	19500	21100	23800	RMT 84.45 RM 68.38	10840 5426	8650 4330
Finch/ACSS/TW	1113	13	39	91.9	0.1689	19x0.0862	0.4310	0.9845	0.8737	1.18	1427	1051	376	73.64	26.36	30400	33200	38700	RMT 90.45 RMT 84.36	14556 7278	10200 5100
Oxbird/ACSS/TW	1192.5	5	30	93.2	0.1993	7x0.0936	0.2808	0.9843	0.9361	1.17	1285	1122	163	87.31	12.69	17500	18700	20900	RMT 84.36 RM 66.32	9446 4717	7350 3670

(1) Code words shown denote ACSS/TW with regular-strength Class A zinc-5% aluminum mischmetal alloy-coated steel core (MA2). See the Options section to find the appropriate code word modifier designation for alternative design options.
 (2) Due to rounding, total values may be slightly greater or slightly less than the sum of the component values.
 (3) Weights shown are for conductor only and do not include the reel. Normal length and shipping tolerances apply.
 Dimensions and weights not designated minimum or maximum are nominal values and subject to manufacturing tolerances. In this context, weight means mass.

TransPowr® ACSS/TW Bare Overhead Conductor

Trapezoidal Aluminum Conductor Steel-Supported Concentric-Lay-Stranded

ACSS/TW (ELECTRICAL PROPERTIES) – REDUCED DIAMETER - CONDUCTORS SIZED TO HAVE EQUIVALENT CIRCULAR MIL AREA TO REGULAR ACSS

CODE WORD (1)	SIZE AWG OR kcmil	TYPE	NO. AL WIRES	FILL FACTOR	EQUIVALENT AL DIA. INCHES	STEEL CORE NO. X DIA. INCHES	STEEL CORE O.D. INCHES	CROSS-SECTION SQ. INCHES			RESISTANCE (4) OHMS/1000 FT				AMPACITY (5)		GEOMETRIC MEAN RADIUS FT	INDUCTIVE REACTANCE OHM/1000 FT (6)	CAPACITIVE REACTANCE MEGAOHM 1000 FT (6)
								TOTAL	AL	O.D. INCHES	DC @ 20°C	AC @ 25°C	AC @ 75°C	AC @ 200°C	75°C	200°C			
Oriole/ACSS/TW	336.4	23	17	88.7	0.1407	7x0.1059	0.3177	0.3258	0.2642	0.69	0.0488	0.0499	0.0600	0.0851	530	940	0.0236	0.0861	0.5552
Flicker/ACSS/TW	477	13	18	91.3	0.1628	7x0.0940	0.2820	0.4234	0.3748	0.78	0.0347	0.0356	0.0427	0.0606	650	1150	0.0259	0.0839	0.5375
Hawk/ACSS/TW	477	16	18	91.3	0.1628	7x0.1053	0.3159	0.4355	0.3745	0.79	0.0346	0.0354	0.0426	0.0604	650	1160	0.0266	0.0834	0.5349
Hen/ACSS/TW	477	23	16	88.7	0.1727	7x0.1261	0.3783	0.4620	0.3746	0.83	0.0344	0.0352	0.0423	0.0601	660	1180	0.0280	0.0822	0.5278
Parakeet/ACSS/TW	556.5	13	18	92.0	0.1758	7x0.1015	0.3045	0.4938	0.4372	0.84	0.0297	0.0305	0.0367	0.0520	715	1270	0.0279	0.0822	0.5259
Dove/ACSS/TW	556.5	16	20	91.8	0.1668	7x0.1138	0.3414	0.5083	0.4371	0.85	0.0296	0.0304	0.0365	0.0518	720	1280	0.0287	0.0816	0.5232
Rook/ACSS/TW	636	13	18	92.6	0.1880	7x0.1085	0.3255	0.5641	0.4994	0.89	0.0260	0.0268	0.0321	0.0455	775	1385	0.0298	0.0808	0.5159
Grosbeak/ACSS/TW	636	16	20	92.0	0.1783	7x0.1216	0.3648	0.5809	0.4996	0.91	0.0259	0.0267	0.0320	0.0453	780	1400	0.0307	0.0801	0.5129
Term/ACSS/TW	795	7	17	93.5	0.2163	7x0.0888	0.2664	0.6680	0.6247	0.96	0.0209	0.0217	0.0260	0.0368	880	1580	0.0315	0.0795	0.5042
Puffin/ACSS/TW	795	11	21	93.5	0.1945	7x0.1108	0.3324	0.6916	0.6241	0.98	0.0209	0.0216	0.0259	0.0366	885	1595	0.0327	0.0786	0.5009
Condor/ACSS/TW	795	13	21	93.0	0.1945	7x0.1213	0.3639	0.7051	0.6242	0.99	0.0208	0.0215	0.0258	0.0365	890	1605	0.0333	0.0782	0.4987
Drake/ACSS/TW	795	16	20	93.1	0.1993	7x0.1360	0.4080	0.7259	0.6242	1.01	0.0207	0.0214	0.0257	0.0363	895	1615	0.0342	0.0776	0.4962
Mallard/ACSS/TW	795	23	22	93.0	0.1901	19x0.0977	0.4885	0.7668	0.6244	1.05	0.0207	0.0213	0.0255	0.0361	905	1640	0.0360	0.0764	0.4907
Phoenix/ACSS/TW	954	5	30	92.9	0.1784	7x0.0837	0.2511	0.7882	0.7497	1.04	0.0176	0.0185	0.0228	0.0329	960	1715	0.0343	0.0775	0.4910
Rail/ACSS/TW	954	7	33	92.2	0.1700	7x0.0971	0.2913	0.8011	0.7493	1.06	0.0175	0.0184	0.0227	0.0328	965	1725	0.0350	0.0771	0.4889
Cardinal/ACSS/TW	954	13	21	93.9	0.2131	7x0.1329	0.3987	0.8463	0.7492	1.08	0.0173	0.0180	0.0216	0.0305	995	1805	0.0364	0.0762	0.4851
Snowbird/ACSS/TW	1033.5	5	30	92.5	0.1856	7x0.0871	0.2613	0.8532	0.8115	1.09	0.0162	0.0171	0.0211	0.0304	1010	1810	0.0357	0.0766	0.4844
Ortolan/ACSS/TW	1033.5	7	33	92.3	0.1769	7x0.1010	0.3030	0.8673	0.8112	1.10	0.0162	0.0171	0.0210	0.0303	1015	1820	0.0364	0.0762	0.4827
Curlew/ACSS/TW	1033.5	13	21	93.7	0.2219	7x0.1383	0.4149	0.9170	0.8118	1.13	0.0160	0.0167	0.0199	0.0281	1045	1905	0.0379	0.0752	0.4787
Avocet/ACSS/TW	1113	5	30	93.0	0.1926	7x0.0904	0.2712	0.9186	0.8737	1.13	0.0150	0.0160	0.0196	0.0282	1055	1900	0.0370	0.0758	0.4790
Bluejay/ACSS/TW	1113	7	33	92.7	0.1837	7x0.1049	0.3147	0.9351	0.8746	1.14	0.0150	0.0159	0.0195	0.0282	1060	1910	0.0377	0.0753	0.4772
Finch/ACSS/TW	1113	13	39	91.9	0.1689	19x0.0862	0.4310	0.9845	0.8737	1.18	0.0150	0.0157	0.0194	0.0279	1075	1935	0.0399	0.0740	0.4716
Oxbird/ACSS/TW	1192.5	5	30	93.2	0.1993	7x0.0936	0.2808	0.9843	0.9361	1.17	0.0140	0.0150	0.0183	0.0263	1100	1985	0.0382	0.0750	0.4738

(1) Code words shown denote ACSS/TW with regular-strength Class A zinc-5% aluminum mischmetal alloy-coated steel core (MA2). See the Options section to find the appropriate code word modifier designation for alternative design options.

(4) Based on a conductivity of 61.2% (minimum lot average) IACS at 20°C for aluminum and 8% IACS at 20°C for the steel core. AC resistance for single-layer and three-layer designs approximates the effects of core magnetization. To convert to ohms/mile, multiply by 5.28. To convert to ohms/km, multiply by 3.281.

(5) Based on the given conductor temperature at 60 Hz and the following conditions: 25°C ambient temperature, 2 ft/sec crosswind (90° to conductor), 0.5 coefficient of emissivity, 0.5 coefficient of absorptivity, 30° northern latitude, sea level elevation, 90° azimuth of line (East-West), clear atmosphere, and a date and time of noon on July 1 (resulting in 96.0 W/ft² of solar and sky radiated heat). Actual ampacity will differ based on local conditions. For specific ampacities, please contact your General Cable sales representative.

(6) Values for inductive reactance and capacitive reactance are expressed in terms of a 1 ft radius (30.48 cm). To convert the Geometric Mean Radius (GMR) to cm, divide the value by 0.03821. To convert inductive reactance to ohm/km, multiply the value by 3.281. To convert capacitive reactance to ohm/km, divide the value by 3.281.



TransPow[®] ACSS/TW Bare Overhead Conductor

Trapezoidal Aluminum Conductor Steel-Supported Concentric-Lay-Stranded

ACSS/TW (MECHANICAL PROPERTIES) – REDUCED DIAMETER - CONDUCTORS SIZED TO HAVE EQUIVALENT CIRCULAR MIL AREA TO REGULAR ACSS

CODE WORD (1)	SIZE AWG OR kcmil	TYPE	NO. AL WIRES	FILL FACTOR	EQUIVALENT AL DIA. INCHES	STEEL CORE NO. X DIA. INCHES	STEEL CORE O.D. INCHES	CROSS-SECTION SQ. INCHES			APPROX. WEIGHT LB/1000 FT (2)			PERCENT BY MASS		RATED STRENGTH LBS			STANDARD PACKAGES (3)		
								TOTAL	AL	O.D. INCHES	TOTAL	AL	STEEL	AL	STEEL	MA2	MA3	MA5	REEL DESIG.	WEIGHT LBS	LENGTH FEET
Bunting/ACSS/TW	1192.5	7	33	93.0	0.1901	7x0.1086	0.3258	1.0016	0.9368	1.18	1343	1123	220	83.65	16.35	20900	22600	25500	RMT 84.45 RM 68.38	10849 5425	8080 4040
Grackle/ACSS/TW	1192.5	13	39	92.3	0.1749	19x0.0892	0.4460	1.0556	0.9369	1.22	1529	1126	403	73.65	26.35	32600	35500	41500	RMT 90.45 RM 72.36	14569 7277	9530 4760
Scissortail/ACSS/TW	1272	5	30	93.6	0.2059	7x0.0967	0.2901	1.0508	0.9994	1.20	1371	1197	174	87.30	12.70	18700	20000	22300	RMT 84.36 RM 66.32	9460 4730	6900 3450
Bittern/ACSS/TW	1272	7	33	93.3	0.1964	7x0.1121	0.3363	1.0685	0.9994	1.22	1432	1198	234	83.67	16.33	22300	24000	27200	RMT 84.45 RM 68.38	10854 5427	7580 3790
Pheasant/ACSS/TW	1272	13	39	93.0	0.1806	19x0.0921	0.4605	1.1252	0.9987	1.26	1630	1201	429	73.66	26.34	34100	37300	43000	RMT 90.45 RM 72.36	14559 7272	8930 4460
Dipper/ACSS/TW	1351.5	7	33	93.5	0.2024	7x0.1155	0.3465	1.1350	1.0616	1.25	1521	1273	248	83.68	16.32	23700	25500	28800	RMT 84.45 RM 68.38	10847 5416	7130 3560
Martin/ACSS/TW	1351.5	13	39	93.0	0.1861	19x0.0949	0.4745	1.1954	1.0610	1.30	1732	1276	456	73.68	26.32	36200	39600	45600	RMT 90.45 RM 72.36	14548 7274	8400 4200
Bobolink/ACSS/TW	1431	7	33	93.0	0.2083	7x0.1189	0.3567	1.2020	1.1243	1.29	1611	1348	263	83.67	16.33	25100	27100	30500	RMT 84.45 RM 68.38	10842 5413	6730 3360
Plover/ACSS/TW	1431	13	39	93.0	0.1916	19x0.0977	0.4885	1.2666	1.1242	1.33	1834	1351	483	73.66	26.34	38400	41900	48300	RMT 90.45 RM 72.36	14565 7282	7940 3970
Lapwing/ACSS/TW	1590	7	36	93.0	0.2102	7x0.1253	0.3759	1.3351	1.2488	1.36	1790	1498	292	83.67	16.33	27900	29600	33500	RMT 84.45 RM 68.38	11831 5906	6610 3300
Falcon/ACSS/TW	1590	13	42	93.5	0.1946	19x0.1030	0.5150	1.4066	1.2483	1.40	2038	1501	537	73.65	26.35	42600	46600	53700	RMT 90.45 RMT 84.36	15674 7827	7690 3840
Chukar/ACSS/TW	1780	8	38	93.5	0.2164	19x0.0874	0.4370	1.5122	1.3982	1.45	2061	1674	387	81.24	18.76	35300	38200	43900	RMT 90.45 RM 68.38	12859 6430	6240 3120
Bluebird/ACSS/TW	2156	8	64	91.0	0.1835	19x0.0961	0.4805	1.8312	1.6934	1.61	2512	2045	467	81.39	18.61	42100	45500	51700	RMT 96.60 RMT 84.45	21629 10802	8610 4300

ACSS/TW (MECHANICAL PROPERTIES) – EQUIVALENT DIAMETER - CONDUCTORS SIZED TO HAVE EQUIVALENT DIAMETER TO REGULAR ACSS

CODE WORD (1)	SIZE AWG OR kcmil	TYPE	NO. AL WIRES	FILL FACTOR	EQUIVALENT AL DIA. INCHES	STEEL CORE NO. X DIA. INCHES	STEEL CORE O.D. INCHES	CROSS-SECTION SQ. INCHES			APPROX. WEIGHT LB/1000 FT (2)			PERCENT BY MASS		RATED STRENGTH LBS			STANDARD PACKAGES (3)		
								TOTAL	AL	O.D. INCHES	TOTAL	AL	STEEL	AL	STEEL	MA2	MA3	MA5	REEL DESIG.	WEIGHT LBS	LENGTH FEET
Calumet/ACSS/TW	565.3	16	20	91.5	0.1681	7x0.1146	0.3438	0.5161	0.4438	0.86	776	531	244	68.48	31.52	18400	20200	23500	RMT 84.36 NR 60.28	8027 4010	10350 5170
Mohawk/ACSS/TW	571.7	13	18	92.2	0.1782	7x0.1030	0.3090	0.5072	0.4489	0.85	734	537	197	73.10	26.90	15600	17100	19700	RM 66.38 NR 60.28	6768 3384	9220 4610
Oswego/ACSS/TW	664.8	16	20	92.3	0.1823	7x0.1244	0.3732	0.6073	0.5222	0.93	913	625	288	68.44	31.56	21700	23400	27200	RMT 84.36 NR 60.28	8032 4016	8800 4400
Mystic/ACSS/TW	666.6	13	20	92.3	0.1826	7x0.1111	0.3333	0.5915	0.5236	0.91	855	626	230	73.14	26.86	18200	19900	22900	RMT 84.36 NR 60.28	7519 3755	8790 4390
Wabash/ACSS/TW	762.8	16	20	92.9	0.1953	7x0.1331	0.3993	0.6963	0.5989	0.99	1046	717	330	68.49	31.51	24900	26800	31200	RMT 84.36 NR 60.28	8026 4008	7670 3830
Maumee/ACSS/TW	768.2	13	20	93.0	0.1960	7x0.1195	0.3585	0.6817	0.6032	0.98	987	721	266	73.07	26.93	21000	23000	26500	RMT 84.36 NR 60.28	7520 3760	7620 3810
Kettle/ACSS/TW	957.2	7	33	92.2	0.1703	7x0.0973	0.2919	0.8038	0.7518	1.06	1078	902	176	83.65	16.35	16800	18100	20400	RMT 84.45 RM 68.38	10843 5421	10060 5030
Suwanee/ACSS/TW	959.6	16	22	93.4	0.2089	7x0.1493	0.4479	0.8764	0.7539	1.11	1317	902	415	68.49	31.51	30700	33100	38600	RMT 84.36 RM 66.32	8834 4410	6710 3350

(1) Code words shown denote ACSS/TW with regular-strength Class A zinc-5% aluminum mischmetal alloy-coated steel core (MA2). See the Options section to find the appropriate code word modifier designation for alternative design options.
 (2) Due to rounding, total values may be slightly greater or slightly less than the sum of the component values.
 (3) Weights shown are for conductor only and do not include the reel. Normal length and shipping tolerances apply.
 Dimensions and weights not designated minimum or maximum are nominal values and subject to manufacturing tolerances. In this context, weight means mass.

TransPwr® ACSS/TW Bare Overhead Conductor

Trapezoidal Aluminum Conductor Steel-Supported Concentric-Lay-Stranded

ACSS/TW (ELECTRICAL PROPERTIES) – REDUCED DIAMETER - CONDUCTORS SIZED TO HAVE EQUIVALENT CIRCULAR MIL AREA TO REGULAR ACSS

CODE WORD (1)	SIZE AWG OR kcmil	TYPE	NO. AL WIRES	FILL FACTOR	EQUIVALENT AL DIA. INCHES	STEEL CORE NO. X DIA. INCHES	STEEL CORE O.D. INCHES	CROSS-SECTION SQ. INCHES			RESISTANCE (4) OHMS/1000 FT				AMPACITY (5)		GEOMETRIC MEAN RADIUS FT	INDUCTIVE REACTANCE OHM/1000 FT (6)	CAPACITIVE REACTANCE MEGAOHM 1000 FT (6)
								TOTAL	AL	O.D. INCHES	DC @ 20°C	AC @ 25°C	AC @ 75°C	AC @ 200°C	75°C	200°C			
Bunting/ACSS/TW	1192.5	7	33	93.0	0.1901	7x0.1086	0.3258	1.0016	0.9368	1.18	0.0140	0.0149	0.0183	0.0263	1105	1995	0.0390	0.0746	0.4720
Grackle/ACSS/TW	1192.5	13	39	92.3	0.1749	19x0.0892	0.4460	1.0556	0.9369	1.22	0.0140	0.0147	0.0181	0.0261	1120	2025	0.0412	0.0733	0.4665
Scissortail/ACSS/TW	1272	5	30	93.6	0.2059	7x0.0967	0.2901	1.0508	0.9994	1.20	0.0132	0.0141	0.0172	0.0247	1145	2070	0.0394	0.0743	0.4690
Bittern/ACSS/TW	1272	7	33	93.3	0.1964	7x0.1121	0.3363	1.0685	0.9994	1.22	0.0131	0.0141	0.0172	0.0247	1150	2080	0.0402	0.0739	0.4672
Pheasant/ACSS/TW	1272	13	39	93.0	0.1806	19x0.0921	0.4605	1.1252	0.9987	1.26	0.0131	0.0139	0.0170	0.0245	1165	2115	0.0424	0.0726	0.4619
Dipper/ACSS/TW	1351.5	7	33	93.5	0.2024	7x0.1155	0.3465	1.1350	1.0616	1.25	0.0124	0.0133	0.0162	0.0232	1190	2165	0.0414	0.0732	0.4626
Martin/ACSS/TW	1351.5	13	39	93.0	0.1861	19x0.0949	0.4745	1.1954	1.0610	1.30	0.0123	0.0131	0.0160	0.0230	1210	2200	0.0437	0.0719	0.4572
Bobolink/ACSS/TW	1431	7	33	93.0	0.2083	7x0.1189	0.3567	1.2020	1.1243	1.29	0.0117	0.0126	0.0154	0.0220	1235	2250	0.0427	0.0725	0.4578
Plover/ACSS/TW	1431	13	39	93.0	0.1916	19x0.0977	0.4885	1.2666	1.1242	1.33	0.0116	0.0124	0.0152	0.0218	1255	2285	0.0450	0.0713	0.4527
Lapwing/ACSS/TW	1590	7	36	93.0	0.2102	7x0.1253	0.3759	1.3351	1.2488	1.36	0.0105	0.0115	0.0139	0.0198	1315	2410	0.0450	0.0712	0.4495
Falcon/ACSS/TW	1590	13	42	93.5	0.1946	19x0.1030	0.5150	1.4066	1.2483	1.40	0.0105	0.0113	0.0137	0.0196	1335	2445	0.0474	0.0701	0.4448
Chukar/ACSS/TW	1780	8	38	93.5	0.2164	19x0.0874	0.4370	1.5122	1.3982	1.45	0.00937	0.0103	0.0125	0.0177	1415	2605	0.0482	0.0697	0.4398
Bluebird/ACSS/TW	2156	8	64	91.0	0.1835	19x0.0961	0.4805	1.8312	1.6934	1.61	0.00780	0.00879	0.0103	0.0141	1600	3015	0.0538	0.0671	0.4229

ACSS/TW (ELECTRICAL PROPERTIES) – EQUIVALENT DIAMETER - CONDUCTORS SIZED TO HAVE EQUIVALENT DIAMETER TO REGULAR ACSS

CODE WORD (1)	SIZE AWG OR kcmil	TYPE	NO. AL WIRES	FILL FACTOR	EQUIVALENT AL DIA. INCHES	STEEL CORE NO. X DIA. INCHES	STEEL CORE O.D. INCHES	CROSS-SECTION SQ. INCHES			RESISTANCE (4) OHMS/1000 FT				AMPACITY (5)		GEOMETRIC MEAN RADIUS FT	INDUCTIVE REACTANCE OHM/1000 FT (6)	CAPACITIVE REACTANCE MEGAOHM 1000 FT (6)
								TOTAL	AL	O.D. INCHES	DC @ 20°C	AC @ 25°C	AC @ 75°C	AC @ 200°C	75°C	200°C			
Calument/ACSS/TW	565.3	16	20	91.5	0.1681	7x0.1146	0.3438	0.5161	0.4438	0.86	0.0292	0.0299	0.0359	0.0510	725	1295	0.0290	0.0814	0.5217
Mohawk/ACSS/TW	571.7	13	18	92.2	0.1782	7x0.1030	0.3090	0.5072	0.4489	0.85	0.0289	0.0297	0.0357	0.0506	725	1295	0.0283	0.0820	0.5239
Oswego/ACSS/TW	664.8	16	20	92.3	0.1823	7x0.1244	0.3732	0.6073	0.5222	0.93	0.0248	0.0255	0.0306	0.0434	800	1440	0.0313	0.0796	0.5096
Mystic/ACSS/TW	666.6	13	20	92.3	0.1826	7x0.1111	0.3333	0.5915	0.5236	0.91	0.0248	0.0256	0.0307	0.0434	800	1430	0.0306	0.0801	0.5120
Wabash/ACSS/TW	762.8	16	20	92.9	0.1953	7x0.1331	0.3993	0.6963	0.5989	0.99	0.0216	0.0223	0.0267	0.0378	875	1575	0.0335	0.0781	0.4993
Maumee/ACSS/TW	768.2	13	20	93.0	0.1960	7x0.1195	0.3585	0.6817	0.6032	0.98	0.0215	0.0222	0.0267	0.0377	870	1570	0.0328	0.0786	0.5014
Kettle/ACSS/TW	957.2	7	33	92.2	0.1703	7x0.0973	0.2919	0.8038	0.7518	1.06	0.0175	0.0184	0.0226	0.0327	965	1730	0.0350	0.0770	0.4886
Suwanee/ACSS/TW	959.6	16	22	93.4	0.2089	7x0.1493	0.4479	0.8764	0.7539	1.11	0.0172	0.0178	0.0213	0.0301	1005	1825	0.0376	0.0754	0.4817

(1) Code words shown denote ACSS/TW with regular-strength Class A zinc-5% aluminum mischmetal alloy-coated steel core (MA2). See the Options section to find the appropriate code word modifier designation for alternative design options.
 (4) Based on a conductivity of 61.2% (minimum lot average) IACS at 20°C for aluminum and 8% IACS at 20°C for the steel core. AC resistance for single-layer and three-layer designs approximates the effects of core magnetization. To convert to ohms/mile, multiply by 5.28. To convert to ohms/km, multiply by 3.281.

(5) Based on the given conductor temperature at 60 Hz and the following conditions: 25°C ambient temperature, 2 ft/sec crosswind (90° to conductor), 0.5 coefficient of emissivity, 0.5 coefficient of absorptivity, 30° northern latitude, sea level elevation, 90° azimuth of line (East-West), clear atmosphere, and a date and time of noon on July 1 (resulting in 96.0 W/ft² of solar and sky radiated heat). Actual ampacity will differ based on local conditions. For specific ampacities, please contact your General Cable sales representative.

(6) Values for inductive reactance and capacitive reactance are expressed in terms of a 1 ft radius (30.48 cm). To convert the Geometric Mean Radius (GMR) to cm, divide the value by 0.03821. To convert inductive reactance to ohm/km, multiply the value by 3.281. To convert capacitive reactance to ohm/km, divide the value by 3.281.



TransPowr® ACSS/TW Bare Overhead Conductor

Trapezoidal Aluminum Conductor Steel-Supported Concentric-Lay-Stranded

ACSS/TW (MECHANICAL PROPERTIES) – EQUIVALENT DIAMETER - CONDUCTORS SIZED TO HAVE EQUIVALENT DIAMETER TO REGULAR ACSS

CODE WORD (1)	SIZE AWG OR kcmil	TYPE	NO. AL WIRES	FILL FACTOR	EQUIVALENT AL DIA. INCHES	STEEL CORE NO. X DIA. INCHES	STEEL CORE O.D. INCHES	CROSS-SECTION SQ. INCHES			APPROX. WEIGHT LB/1000 FT (2)			PERCENT BY MASS		RATED STRENGTH LBS			STANDARD PACKAGES (3)		
								TOTAL	AL	O.D. INCHES	TOTAL	AL	STEEL	AL	STEEL	MA2	MA3	MA5	REEL DESIG.	WEIGHT LBS	LENGTH FEET
Columbia/ACSS/TW	966.2	13	21	93.6	0.2145	7x0.1338	0.4014	0.8576	0.7591	1.09	1240	907	333	73.13	26.87	26400	28300	32800	RMT 84.36 RM 66.32	7899 3943	6370 3180
Genesee/ACSS/TW	1158	7	33	92.5	0.1873	7x0.1078	0.3234	0.9732	0.9094	1.16	1307	1091	216	83.45	16.55	20500	22100	25000	RMT 84.45 RM 68.38	10874 5437	8320 4160
Hudson/ACSS/TW	1158.4	13	26	93.7	0.2111	7x0.1467	0.4401	1.0279	0.9096	1.20	1488	1087	401	73.08	26.92	31100	33500	38800	RMT 84.36 RM 66.32	9776 4880	6570 3280
Cheyenne/ACSS/TW	1168.1	5	30	92.9	0.1973	7x0.0926	0.2778	0.9642	0.9170	1.16	1259	1099	160	87.32	12.68	17100	18300	20400	RMT 84.45 RM 66.32	9441 4720	7500 3750
Yukon/ACSS/TW	1233.6	13	39	91.0	0.1778	19x0.0910	0.4550	1.0923	0.9688	1.25	1584	1165	419	73.53	26.47	33200	36300	41900	RMT 90.45 RMT 84.36	14588 7286	9210 4600
Nelson/ACSS/TW	1257.1	7	35	92.4	0.1895	7x0.1115	0.3345	1.0558	0.9875	1.21	1415	1184	231	83.65	16.35	22100	23800	26900	RMT 84.45 RM 68.38	11508 5747	8130 4060
Catawba/ACSS/TW	1272	5	30	93.3	0.2059	7x0.0967	0.2901	1.0507	0.9993	1.20	1371	1197	174	87.30	12.70	18700	20000	22300	RMT 84.36 RM 66.32	5333 4716	3890 3440
Thames/ACSS/TW	1334.6	13	39	92.6	0.1850	19x0.0944	0.4720	1.1808	1.0479	1.29	1711	1260	451	73.64	26.36	35800	39100	45100	RMT 90.45 RM 72.36	14562 7273	8510 4250
Mackenzie/ACSS/TW	1359.7	7	36	92.9	0.1943	7x0.1159	0.3477	1.1413	1.0674	1.26	1531	1281	250	83.67	16.33	23800	25700	29000	RMT 84.45 RM 68.38	11832 5909	7730 3860
Truckee/ACSS/TW	1372.5	5	30	93.6	0.2139	7x0.1004	0.3012	1.1337	1.0783	1.25	1479	1291	188	87.32	12.68	20200	21500	24000	RMT 84.36 RM 66.32	9451 4718	6390 3190
Merrimack/ACSS/TW	1433.6	13	39	92.1	0.1917	19x0.0978	0.4890	1.2682	1.1255	1.34	1838	1354	484	73.65	26.35	38400	42000	48400	RMT 90.45 RM 72.36	14555 7278	7920 3960
Miramichi/ACSS/TW	1455.3	7	36	93.4	0.2010	7x0.1200	0.3600	1.2219	1.1427	1.30	1639	1371	268	83.64	16.36	25600	27100	30700	RMT 84.45 RM 68.38	11832 5916	7220 3610
St. Croix/ACSS/TW	1467.8	5	30	93.4	0.2212	7x0.1041	0.3123	1.2127	1.1532	1.29	1583	1381	202	87.26	12.74	21600	23100	25800	RMT 84.36 RM 66.32	10320 5160	6520 3260
Rio Grande/ACSS/TW	1533.3	13	39	93.2	0.1983	19x0.1012	0.5060	1.3574	1.2046	1.38	1966	1448	518	73.63	26.37	41200	45000	51900	RMT 90.45 RM 72.36	14569 7275	7410 3700
Potomac/ACSS/TW	1557.4	7	36	93.2	0.2080	7x0.1241	0.3723	1.3084	1.2237	1.35	1754	1467	287	83.65	16.35	27300	29000	32800	RMT 84.45 RM 68.38	11836 5909	6750 3370
Platte/ACSS/TW	1569	5	33	93.7	0.2181	7x0.1074	0.3222	1.2962	1.2328	1.33	1691	1476	215	87.30	12.70	23100	24600	27500	RMT 84.45 RM 68.38	10383 5192	6140 3070
Pecos/ACSS/TW	1622	13	39	93.0	0.2039	19x0.1064	0.5320	1.4425	1.2736	1.42	2105	1531	573	72.77	27.23	45000	49200	56900	RMT 90.45 RM 72.36	14732 7366	7000 3500
Schuykill/ACSS/TW	1657.4	7	36	93.5	0.2145	7x0.1280	0.3840	1.3912	1.3012	1.39	1866	1561	305	83.66	16.34	29100	30900	34900	RMT 84.45 RM 68.38	11831 5915	6340 3170
James/ACSS/TW	1730.6	13	39	92.5	0.2107	19x0.1075	0.5375	1.5322	1.3598	1.47	2219	1634	585	73.64	26.36	46400	50800	58500	RMT 90.45 RM 72.36	14557 7278	6560 3280
Pee Dee/ACSS/TW	1758.6	7	37	93.1	0.2180	7x0.1319	0.3957	1.4764	1.3807	1.43	1980	1656	324	83.65	16.35	30900	32800	37100	RMT 90.45 RM 68.38	12159 6079	6140 3070
Cumberland/ACSS/TW	1926.9	13	42	93.3	0.2142	19x0.1133	0.5665	1.7044	1.5129	1.54	2469	1819	650	73.68	26.32	51600	56400	65000	RMT 90.45 RMT 84.36	15679 7827	6350 3170
Athabaska/ACSS/TW	1949.6	7	42	93.4	0.2155	7x0.1392	0.4176	1.6384	1.5318	1.50	2197	1836	361	83.58	16.42	34300	36500	41300	RMT 90.45 RM 72.36	13819 6898	6290 3140
Powder/ACSS/TW	2153.8	8	64	92.2	0.1834	19x0.0961	0.4805	1.8293	1.6915	1.60	2510	2042	467	81.37	18.63	42100	45500	51700	RMT 96.60 RMT 84.45	21611 10793	8610 4300
Santee/ACSS/TW	2627.3	8	64	93.1	0.2027	19x0.1062	0.5310	2.2328	2.0645	1.76	3062	2492	571	81.36	18.64	51300	55600	63100	RMT 96.60 RMT 84.45	21621 10810	7060 3530

(1) Code words shown denote ACSS/TW with regular-strength Class A zinc-5% aluminum mischmetal alloy-coated steel core (MA2). See the Options section to find the appropriate code word modifier designation for alternative design options.

(2) Due to rounding, total values may be slightly greater or slightly less than the sum of the component values.

(3) Weights shown are for conductor only and do not include the reel. Normal length and shipping tolerances apply.

Dimensions and weights not designated minimum or maximum are nominal values and subject to manufacturing tolerances. In this context, weight means mass.

TransPowr® ACSS/TW Bare Overhead Conductor

Trapezoidal Aluminum Conductor Steel-Supported Concentric-Lay-Stranded

ACSS/TW (ELECTRICAL PROPERTIES) – EQUIVALENT DIAMETER - CONDUCTORS SIZED TO HAVE EQUIVALENT DIAMETER TO REGULAR ACSS

CODE WORD (1)	SIZE AWG OR kcmil	NO. AL WIRES	FILL FACTOR	EQUIVALENT AL DIA. INCHES	STEEL CORE NO. X DIA. INCHES	STEEL CORE O.D. INCHES	CROSS-SECTION SQ. INCHES		O.D. INCHES	RESISTANCE (4) OHMS/1000 FT				AMPACITY (5)		GEOMETRIC MEAN RADIUS FT	INDUCTIVE REACTANCE OHM/1000 FT (6)	CAPACITIVE REACTANCE MEGAOHM 1000 FT (6)	
							TOTAL	AL		DC @ 20°C	AC @ 25°C	AC @ 75°C	AC @ 200°C	75°C	200°C				
Columbia/ACSS/TW	966.2	13	21	93.6	0.2145	7x0.1338	0.4014	0.8576	0.7591	1.09	0.0171	0.0178	0.0213	0.0301	1005	1820	0.0367	0.0760	0.4839
Genesee/ACSS/TW	1158	7	33	92.5	0.1873	7x0.1078	0.3234	0.9732	0.9094	1.16	0.0144	0.0153	0.0188	0.0271	1085	1960	0.0385	0.0748	0.4739
Hudson/ACSS/TW	1158.4	13	26	93.7	0.2111	7x0.1467	0.4401	1.0279	0.9096	1.20	0.0143	0.0150	0.0179	0.0252	1125	2050	0.0402	0.0738	0.4697
Cheyenne/ACSS/TW	1168.1	5	30	92.9	0.1973	7x0.0926	0.2778	0.9642	0.9170	1.16	0.0143	0.0153	0.0187	0.0269	1085	1960	0.0379	0.0752	0.4751
Yukon/ACSS/TW	1233.6	13	39	91.0	0.1778	19x0.0910	0.4550	1.0923	0.9688	1.25	0.0135	0.0143	0.0175	0.0252	1145	2075	0.0422	0.0727	0.4628
Nelson/ACSS/TW	1257.1	7	35	92.4	0.1895	7x0.1115	0.3345	1.0558	0.9875	1.21	0.0133	0.0142	0.0174	0.0249	1140	2070	0.0402	0.0739	0.4674
Catawba/ACSS/TW	1272	5	30	93.3	0.2059	7x0.0967	0.2901	1.0507	0.9993	1.20	0.0132	0.0141	0.0173	0.0247	1145	2070	0.0395	0.0743	0.4688
Thames/ACSS/TW	1334.6	13	39	92.6	0.1850	19x0.0944	0.4720	1.1808	1.0479	1.29	0.0125	0.0133	0.0162	0.0233	1200	2180	0.0436	0.0720	0.4579
Mackenzie/ACSS/TW	1359.7	7	36	92.9	0.1943	7x0.1159	0.3477	1.1413	1.0674	1.26	0.0123	0.0132	0.0161	0.0231	1200	2175	0.0417	0.0730	0.4617
Truckee/ACSS/TW	1372.5	5	30	93.6	0.2139	7x0.1004	0.3012	1.1337	1.0783	1.25	0.0122	0.0132	0.0160	0.0229	1200	2175	0.0409	0.0734	0.4631
Merrimack/ACSS/TW	1433.6	13	39	92.1	0.1917	19x0.0978	0.4890	1.2682	1.1255	1.34	0.0116	0.0124	0.0152	0.0217	1255	2290	0.0452	0.0711	0.4519
Miramichi/ACSS/TW	1455.3	7	36	93.4	0.2010	7x0.1200	0.3600	1.2219	1.1427	1.30	0.0115	0.0124	0.0151	0.0216	1245	2275	0.0430	0.0723	0.4568
St. Croix/ACSS/TW	1467.8	5	30	93.4	0.2212	7x0.1041	0.3123	1.2127	1.1532	1.29	0.0114	0.0124	0.0151	0.0215	1250	2275	0.0424	0.0726	0.4576
Rio Grande/ACSS/TW	1533.3	13	39	93.2	0.1983	19x0.1012	0.5060	1.3574	1.2046	1.38	0.0109	0.0117	0.0142	0.0203	1305	2390	0.0466	0.0705	0.4474
Potomac/ACSS/TW	1557.4	7	36	93.2	0.2080	7x0.1241	0.3723	1.3084	1.2237	1.35	0.0107	0.0117	0.0142	0.0202	1300	2375	0.0445	0.0715	0.4513
Platte/ACSS/TW	1569	5	33	93.7	0.2181	7x0.1074	0.3222	1.2962	1.2328	1.33	0.0107	0.0117	0.0142	0.0201	1300	2375	0.0438	0.0719	0.4527
Pecos/ACSS/TW	1622	13	39	93.0	0.2039	19x0.1064	0.5320	1.4425	1.2736	1.42	0.0103	0.0111	0.0135	0.0192	1355	2485	0.0482	0.0697	0.4424
Schuylkill/ACSS/TW	1657.4	7	36	93.5	0.2145	7x0.1280	0.3840	1.3912	1.3012	1.39	0.0101	0.0111	0.0134	0.0190	1350	2475	0.0459	0.0708	0.4467
James/ACSS/TW	1730.6	13	39	92.5	0.2107	19x0.1075	0.5375	1.5322	1.3598	1.47	0.00962	0.0105	0.0127	0.0181	1405	2590	0.0496	0.0690	0.4374
Pee Dee/ACSS/TW	1758.6	7	37	93.1	0.2180	7x0.1319	0.3957	1.4764	1.3807	1.43	0.00951	0.0105	0.0127	0.0180	1395	2570	0.0474	0.0701	0.4416
Cumberland/ACSS/TW	1926.9	13	42	93.3	0.2142	19x0.1133	0.5665	1.7044	1.5129	1.54	0.00864	0.00951	0.0115	0.0163	1500	2770	0.0522	0.0678	0.4296
Athabaska/ACSS/TW	1949.6	7	42	93.4	0.2155	7x0.1392	0.4176	1.6384	1.5318	1.50	0.00858	0.00962	0.0116	0.0163	1485	2750	0.0499	0.0689	0.4338
Powder/ACSS/TW	2153.8	8	64	92.2	0.1834	19x0.0961	0.4805	1.8293	1.6915	1.60	0.00780	0.00879	0.0103	0.0141	1600	3010	0.0535	0.0673	0.4239
Santee/ACSS/TW	2627.3	8	64	93.1	0.2027	19x0.1062	0.5310	2.2328	2.0645	1.76	0.00640	0.00750	0.00869	0.0118	1785	3405	0.0589	0.0651	0.4090

(1) Code words shown denote ACSS/TW with regular-strength Class A zinc-5% aluminum mischmetal alloy-coated steel core (MA2). See the Options section to find the appropriate code word modifier designation for alternative design options.

(4) Based on a conductivity of 61.2% (minimum lot average) IACS at 20°C for aluminum and 8% IACS at 20°C for the steel core. AC resistance for single-layer and three-layer designs approximates the effects of core magnetization. To convert to ohms/mile, multiply by 5.28. To convert to ohms/km, multiply by 3.281.

(5) Based on the given conductor temperature at 60 Hz and the following conditions: 25°C ambient temperature, 2 ft/sec crosswind (90° to conductor), 0.5 coefficient of emissivity, 0.5 coefficient of absorptivity, 30° northern latitude, sea level elevation, 90° azimuth of line (East-West), clear atmosphere, and a date and time of noon on July 1 (resulting in 96.0 W/ft² of solar and sky radiated heat). Actual ampacity will differ based on local conditions. For specific ampacities, please contact your General Cable sales representative.

(6) Values for inductive reactance and capacitive reactance are expressed in terms of a 1 ft radius (30.48 cm). To convert the Geometric Mean Radius (GMR) to cm, divide the value by 0.03821. To convert inductive reactance to ohm/km, multiply the value by 3.281. To convert capacitive reactance to ohm/km, divide the value by 3.281.



Notes

TransPowr® ACSR/SD Bare Overhead Conductor

Self-Damping Aluminum Conductor Steel-Reinforced Concentric-Lay-Stranded

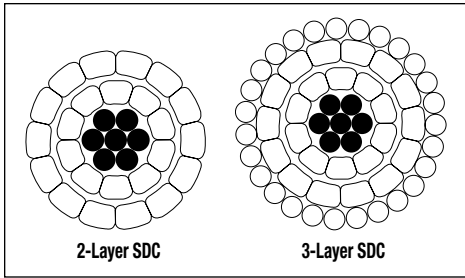

Product Construction:

Complete Conductor:

ACSR/SD conductors are manufactured with two layers of 1350 H19 trapezoidal-shaped aluminum wires concentrically stranded around a steel core of round coated steel wires. On certain larger conductor constructions, the trapezoidal-shaped wires are surrounded by a layer of round 1350 H19 aluminum wires. The steel core and the two layers of trapezoidal-shaped aluminum wires are separated by a gap to provide the self-damping characteristics. Steel core wires are protected from corrosion by aluminum-clad, galvanized, or zinc-5% aluminum mischmetal alloy coating. Standard, high, extra- and ultra-high-strength steel is also available. The ACSR/SD conductors are manufactured in accordance with the requirements of the latest issue of ASTM B701.

Features and Benefits:

The steel core and the two layers of trapezoidal-shaped aluminum wires in ACSR/SD are separated by a gap designed to provide self-damping characteristics to control Aeolian vibration—eliminating the need for vibration dampers. Additional advantages in using ACSR/SD include: shorter, more economical towers, increased reliability, lower overall line cost, reduced sag, reduced ice and wind loads as well as permitting longer spans.

Applications:

ACSR/SD conductors are used for overhead transmission lines to control Aeolian vibration.

Options:

- High-conductivity aluminum (/HC) (62.2% IACS)
- Regular-strength Class C galvanized steel core (/GC2)
- High-strength Class A galvanized steel core (/GA3 to ASTM B606)
- Extra-high-strength Class A galvanized steel core (/GA4 to ASTM B957)

- Ultra-high-strength Class A galvanized steel core (/GA5 to ASTM B957)
- Regular-strength Class A zinc-5% aluminum mischmetal alloy-coated steel core (/MA2 to ASTM B802)
- High-strength Class A zinc-5% aluminum mischmetal alloy-coated steel core (/MA3 to ASTM B803)
- Extra-high-strength Class A zinc-5% aluminum mischmetal alloy-coated steel core (/MA4 to ASTM B958)
- Ultra-high-strength Class A zinc-5% aluminum mischmetal alloy-coated steel core (/MA5 to ASTM B958)
- Aluminum-clad steel core (/AW)
- Non-specular surface finish (/NS)
- E3X® surface coating (/E3X)

At the present time, CAN/CSA C61089 does not recognize ACSR/SD conductor designs. The information provided on the following pages is from our US catalog.

For more information, or information on other conductor sizes, designs and/or specific installation requirements not shown in the tables, contact your General Cable sales representative or e-mail info@generalcable.com.



TransPowr® ACSR/SD Bare Overhead Conductor

Self-Damping Aluminum Conductor Steel-Reinforced Concentric-Lay-Stranded

ACSR/SD CONCENTRIC-LAY-STRANDED (MECHANICAL PROPERTIES)

CODE WORD (1)	SIZE AWGOR kcmil	TYPE	STEEL CORE O.D. INCHES	O.D. INCHES	APPROX. WEIGHT LB/1000 FT (2)			PERCENT BY WEIGHT		RATED STRENGTH LBS	STANDARD PACKAGES (3)		
					TOTAL	AL	STEEL	AL	STEEL		REEL DESIGNATION	WEIGHT POUNDS	LENGTH FEET
Titmouse/SD	266.8	5	0.117	0.593	287	251	36	87.3	12.7	6920	RM 66.32	4017	14000
Eider/SD	266.8	7	0.136	0.601	299	251	49	83.7	16.3	7610	RM 66.32	4192	14000
Spoonbill/SD	266.8	10	0.162	0.610	320	251	69	78.3	21.7	8450	RM 66.32	4480	14000
Partridge/SD	266.8	16	0.236	0.645	367	251	116	68.5	31.5	11350	RM 66.32	4771	13000
Cowbird/SD	336.4	5	0.132	0.667	362	316	46	87.3	12.7	8500	RM 66.32	4343	12000
Hummingbird/SD	336.4	7	0.153	0.664	378	316	62	83.7	16.3	9130	RM 66.32	4532	12000
Woodcock/SD	336.4	10	0.206	0.688	405	317	88	78.3	21.7	11000	RM 66.32	4450	11000
Linnet/SD	326.4	16	0.265	0.716	462	317	145	68.5	31.5	14300	RM 68.38	6011	13000
Erne/SD	397.5	5	0.143	0.717	428	374	54	87.3	12.7	9740	RM 66.32	4277	10000
Longspur/SD	397.5	7	0.166	0.725	446	373	73	83.7	16.3	10600	RM 68.38	5799	13000
Stork/SD	397.5	10	0.224	0.750	478	374	104	78.3	21.7	12900	RM 68.38	5735	12000
Ibis/SD	397.5	16	0.288	0.771	547	375	172	68.5	31.5	16400	RM 68.38	6558	12000
Kestrel/SD	477	5	0.157	0.787	513	448	65	87.3	12.7	11700	RM 68.38	5646	11000
Jackdaw/SD	477	7	0.206	0.808	536	449	87	83.7	16.3	13300	RM 68.38	5894	11000
Toucan/SD	477	10	0.245	0.824	573	449	125	78.3	21.7	15300	RM 68.38	5734	10000
Flicker/SD	477	13	0.282	0.843	614	449	165	73.2	26.8	17200	RMT 84.36	7362	12000
Hawk/SD	477	16	0.316	0.860	656	449	206	68.5	31.5	19500	RMT 84.36	7214	11000
Blackbird/SD	556.5	5	0.169	0.843	599	523	76	87.3	12.7	13600	RM 68.38	5990	10000
Sunbird/SD	556.5	7	0.222	0.863	625	523	102	83.7	16.3	15500	RMT 84.36	6875	11000
Sapsucker/SD	556.5	10	0.265	0.882	669	524	145	78.3	21.7	17800	RMT 84.36	7359	11000
Parakeet/SD	556.5	13	0.305	0.901	716	524	192	73.2	26.8	20000	RMT 84.36	7160	10000
Dove/SD	556.5	16	0.341	0.919	765	524	241	68.5	31.5	22600	RMT 84.36	7650	10000
Pippit/SD	636	5	0.205	0.903	684	598	87	87.3	12.7	16100	RMT 84.36	7524	11000
Killdeer/SD	636	7	0.238	0.917	715	598	117	83.6	16.4	17700	RMT 84.36	7150	10000
Goldfinch/SD	636	10	0.284	0.935	765	599	166	78.3	21.7	20100	RMT 84.36	7650	10000
Rook/SD	636	13	0.326	0.955	818	599	219	73.2	26.8	22900	RMT 84.36	7362	9000
Grosbeak/SD	636	16	0.365	0.975	874	599	275	68.5	31.5	25400	RMT 84.36	7866	9000
Macaw/SD	795	5	0.229	0.999	856	747	109	87.3	12.7	19800	RMT 90.45	11984	14000
Tern/SD	795	7	0.266	1.013	893	747	146	83.6	16.4	21900	RMT 90.45	11609	13000
Puffin/SD	795	10	0.317	1.034	956	746	208	78.3	21.7	25100	RMT 90.45	12428	13000
Condor/SD	795	13	0.364	1.055	1023	749	274	73.2	26.8	28200	RMT 90.45	12276	12000
Drake/SD	795	16	0.408	1.077	1093	749	344	68.5	31.5	31800	RMT 90.45	12023	11000
Phoenix/SD	954	5	0.251	1.088	1027	897	130	87.3	12.7	23700	RMT 90.45	11297	11000
Rail/SD	954	7	0.291	1.103	1073	897	176	83.6	16.4	26100	RMT 90.45	11803	11000
Cardinal/SD	954	13	0.399	1.147	1227	898	329	73.2	26.8	33500	RMT 90.45	12270	10000

(1) Code words shown denote ACSR/SD with regular-strength Class A galvanized steel core ((GA)2). See the Options section to find the appropriate code word modifier designation for alternative design options.

(2) Due to rounding, total values may not exactly equal the sum of the component values.

(3) Weights shown are for conductor only and do not include the reel. Normal length and shipping tolerances apply.

Dimensions and weights not designated minimum or maximum are nominal values and subject to manufacturing tolerances. In this context, weight means mass.

TransPwr® ACSR/SD Bare Overhead Conductor

Self-Damping Aluminum Conductor Steel-Reinforced Concentric-Lay-Stranded

ACSR/SD CONCENTRIC-LAY-STRANDED (ELECTRICAL PROPERTIES)

CODE WORD (1)	SIZE AWGOR kcmil	TYPE	STEEL CORE O.D. INCHES	O.D. INCHES	RESISTANCE (4) OHMS/1000 FT			GEOMETRIC MEAN RADIUS FT	INDUCTIVE REACTANCE OHM / 1000 FT (5)	CAPACITIVE REACTANCE MEGAOHM - 1000 FT (5)
					DC @ 20°C	AC @ 25°C	AC @ 75°C			
Titmouse/SD	266.8	5	0.117	0.593	0.0646	0.0660	0.0790	0.0195	0.0905	0.5797
Eider/SD	266.8	7	0.136	0.601	0.0645	0.0658	0.0788	0.0199	0.0900	0.5776
Spoonbill/SD	266.8	10	0.162	0.610	0.0642	0.0656	0.0785	0.0203	0.0895	0.5755
Partridge/SD	266.8	16	0.236	0.645	0.0637	0.0650	0.0779	0.0220	0.0877	0.5665
Cowbird/SD	336.4	5	0.132	0.667	0.0512	0.0523	0.0626	0.0217	0.0880	0.5613
Hummingbird/SD	336.4	7	0.153	0.664	0.0510	0.0522	0.0625	0.0218	0.0880	0.5618
Woodcock/SD	336.4	10	0.206	0.688	0.0509	0.0520	0.0623	0.0230	0.0867	0.5565
Linnet/SD	326.4	16	0.265	0.716	0.0505	0.0516	0.0618	0.0245	0.0853	0.5502
Erne/SD	397.5	5	0.143	0.717	0.0433	0.0443	0.0530	0.0233	0.0864	0.5496
Longspur/SD	397.5	7	0.166	0.725	0.0432	0.0442	0.0529	0.0238	0.0859	0.5481
Stork/SD	397.5	10	0.224	0.750	0.0431	0.0441	0.0527	0.0249	0.0848	0.5428
Ibis/SD	397.5	16	0.288	0.771	0.0428	0.0437	0.0523	0.0261	0.0838	0.5386
Kestrel/SD	477	5	0.157	0.787	0.0361	0.0370	0.0442	0.0257	0.0842	0.5354
Jackdaw/SD	477	7	0.206	0.808	0.0360	0.0369	0.0441	0.0261	0.0838	0.5333
Toucan/SD	477	10	0.245	0.824	0.0359	0.0368	0.0440	0.0274	0.0827	0.5280
Flicker/SD	477	13	0.282	0.843	0.0358	0.0366	0.0438	0.0283	0.0819	0.5243
Hawk/SD	477	16	0.316	0.860	0.0356	0.0365	0.0437	0.0291	0.0813	0.5217
Blackbird/SD	556.5	5	0.169	0.843	0.0309	0.0317	0.0379	0.0274	0.0827	0.5243
Sunbird/SD	556.5	7	0.222	0.863	0.0309	0.0317	0.0379	0.0285	0.0818	0.5206
Sapsucker/SD	556.5	10	0.265	0.882	0.0308	0.0316	0.0377	0.0293	0.0811	0.5174
Parakeet/SD	556.5	13	0.305	0.901	0.0307	0.0314	0.0376	0.0302	0.0804	0.5143
Dove/SD	556.5	16	0.341	0.919	0.0305	0.0313	0.0374	0.0311	0.0798	0.5111
Pippit/SD	636	5	0.205	0.903	0.0271	0.0278	0.0333	0.0291	0.0813	0.5153
Killdeer/SD	636	7	0.238	0.917	0.0270	0.0277	0.0332	0.0302	0.0804	0.5111
Goldfinch/SD	636	10	0.284	0.935	0.0269	0.0276	0.0330	0.0311	0.0798	0.5085
Rook/SD	636	13	0.326	0.955	0.0268	0.0275	0.0329	0.0320	0.0791	0.5048
Grosbeak/SD	636	16	0.365	0.975	0.0267	0.0274	0.0328	0.0329	0.0784	0.5016
Macaw/SD	795	5	0.229	0.999	0.0217	0.0224	0.0267	0.0326	0.0787	0.4979
Tern/SD	795	7	0.266	1.013	0.0216	0.0223	0.0266	0.0333	0.0782	0.4958
Puffin/SD	795	10	0.317	1.034	0.0215	0.0222	0.0265	0.0343	0.0775	0.4926
Condor/SD	795	13	0.364	1.055	0.0215	0.0221	0.0264	0.0353	0.0769	0.4895
Drake/SD	795	16	0.408	1.077	0.0214	0.0220	0.0263	0.0364	0.0762	0.4863
Phoenix/SD	954	5	0.251	1.088	0.0180	0.0187	0.0223	0.0357	0.0766	0.4847
Rail/SD	954	7	0.291	1.103	0.0180	0.0187	0.0222	0.0364	0.0762	0.4826
Cardinal/SD	954	13	0.399	1.147	0.0179	0.0185	0.0220	0.0384	0.0749	0.4763

(1) Code words shown denote ACSR/SD with regular-strength Class A galvanized steel core (GA2). See the Options section to find the appropriate code word modifier designation for alternative design options.
 (4) Based on a conductivity of 61.0% IACS at 20°C for aluminum and 8% IACS at 20°C for the steel core. AC resistance for three-layer designs must be increased by 1.1%, 2.7%, 3.7%, and 4.3% for current densities of 200, 600, 1000, and 1400 amperes per 1000 kcmil of aluminum to allow for the magnetic losses in the steel core. To convert to ohms/mile, multiply by 5.28. To convert to ohms/km, multiply by 3.281.
 (5) Values for inductive reactance and capacitive reactance are expressed in terms of a 1 ft radius.



TransPowr® ACSR/SD Bare Overhead Conductor

Self-Damping Aluminum Conductor Steel-Reinforced Concentric-Lay-Stranded

ACSR/SD CONCENTRIC-LAY-STRANDED (MECHANICAL PROPERTIES)

CODE WORD (1)	SIZE AWGOR kcmil	TYPE	STEEL CORE O.D. INCHES	O.D. INCHES	APPROX. WEIGHT LB/1000 FT (2)			PERCENT BY WEIGHT		RATED STRENGTH LBS	STANDARD PACKAGES (3)		
					TOTAL	AL	STEEL	AL	STEEL		REEL DESIGNATION	WEIGHT POUNDS	LENGTH FEET
Snowbird/SD	1033.5	5	0.261	1.185	1115	974	141	87.3	12.7	25900	RMT 90.45	11150	10000
Ortolan/SD	1033.5	7	0.303	1.145	1161	971	190	83.6	16.4	28100	RMT 90.45	11610	10000
Curlew/SD	1033.5	13	0.415	1.191	1329	973	356	73.2	26.8	36300	RMT 90.45	11961	9000
Avocet/SD	1113	5	0.271	1.226	1200	1048	152	87.3	12.7	27500	RMT 90.45	10800	9000
Bluejay/SD	1113	7	0.315	1.242	1254	1049	205	83.7	16.3	30300	RMT 90.45	11286	9000
Finch/SD	1113	13	0.431	1.233	1424	1048	376	73.6	26.4	39100	RMT 90.45	12816	9000
Oxbird/SD	1192.5	5	0.281	1.266	1286	1123	163	87.3	12.7	29500	RMT 90.45	11574	9000
Bunting/SD	1192.5	7	0.326	1.284	1343	1124	219	83.7	16.3	32400	RMT 90.45	10744	8000
Grackle/SD	1192.5	13	0.446	1.274	1526	1123	403	73.6	26.4	41900	RMT 90.45	12208	8000
Scissortail/SD	1272	5	0.290	1.305	1372	1198	174	87.3	12.7	31400	RMT 96.60	16464	12000
Bittern/SD	1272	7	0.336	1.323	1433	1199	234	83.7	16.3	34600	RMT 96.60	17196	12000
Pheasant/SD	1272	13	0.461	1.378	1631	1202	429	73.7	26.3	44100	RMT 96.60	19572	12000
Ringdove/SD	1351.5	5	0.299	1.344	1458	1273	185	87.3	12.7	33400	RMT 96.60	17496	12000
Dipper/SD	1351.5	7	0.347	1.361	1522	1274	248	83.7	16.3	36700	RMT 96.60	18264	12000
Frigate/SD	1351.5	10	0.413	1.389	1629	1276	353	78.3	21.7	41700	RMT 96.60	17919	11000
Martin/SD	1351.5	13	0.475	1.417	1733	1277	456	73.7	26.3	46800	RMT 96.60	19063	11000
Popinjay/SD	1431	5	0.308	1.381	1544	1348	196	87.3	12.7	35300	RMT 96.60	16984	11000
Bobolink/SD	1431	7	0.357	1.398	1612	1349	263	83.7	16.3	38900	RMT 96.60	17732	11000
Plover/SD	1431	13	0.489	1.448	1835	1352	483	73.7	26.3	49600	RMT 96.60	20185	11000
Ratite/SD	1590	5	0.325	1.447	1715	1498	218	87.3	12.7	39100	RMT 96.60	17150	10000
Lapwing/SD	1590	7	0.376	1.468	1791	1499	292	83.7	16.3	42600	RMT 96.60	17910	10000
Falcon/SD	1590	13	0.515	1.521	2039	1502	537	73.7	26.3	55100	RMT 96.60	18351	9000
Smew/SD	1780	5	0.343	1.531	1921	1677	244	87.3	12.7	43600	RMT 96.60	17289	9000
Chukar/SD	1780	8	0.437	1.565	2068	1681	387	81.3	18.7	51100	RMT 96.60	18612	9000
Cockatoo/SD	2156	5	0.378	1.731	2331	2036	295	87.3	12.7	52500	RMT 96.60	17483	7500
Bluebird/SD	2156	8	0.481	1.716	2504	2036	468	81.3	18.7	60700	RMT 96.60	18780	7500
Kiwi/SD	2167	4	0.347	1.725	2296	2047	249	89.2	10.8	50700	RMT 96.60	16072	7000

(1) Code words shown denote ACSR/SD with regular-strength Class A galvanized steel core (GA2). See the Options section to find the appropriate code word modifier designation for alternative design options.

(2) Due to rounding, total values may not exactly equal the sum of the component values.

(3) Weights shown are for conductor only and do not include the reel. Normal length and shipping tolerances apply.

Dimensions and weights not designated minimum or maximum are nominal values and subject to manufacturing tolerances. In this context, weight means mass.

TransPowr® ACSR/SD Bare Overhead Conductor

Self-Damping Aluminum Conductor Steel-Reinforced Concentric-Lay-Stranded

ACSR/SD CONCENTRIC-LAY-STRADED (ELECTRICAL PROPERTIES)

CODE WORD (1)	SIZE AWGOR kcmil	TYPE	STEEL CORE O.D. INCHES	O.D. INCHES	RESISTANCE (4) OHMS/1000 FT			GEOMETRIC MEAN RADIUS FT	INDUCTIVE REACTANCE OHM / 1000 FT (5)	CAPACITIVE REACTANCE MEGAOHM - 1000 FT (5)
					DC @ 20°C	AC @ 25°C	AC @ 75°C			
Snowbird/SD	1033.5	5	0.261	1.185	0.0167	0.0175	0.0208	0.0389	0.0746	0.4710
Ortolan/SD	1033.5	7	0.303	1.145	0.0166	0.0174	0.0206	0.0378	0.0753	0.4768
Curlew/SD	1033.5	13	0.415	1.191	0.0165	0.0171	0.0204	0.0400	0.0740	0.4704
Avocet/SD	1113	5	0.271	1.226	0.0155	0.0163	0.0193	0.0402	0.0739	0.4657
Bluejay/SD	1113	7	0.315	1.242	0.0155	0.0162	0.0192	0.0410	0.0734	0.4636
Finch/SD	1113	13	0.431	1.233	0.0153	0.0159	0.0190	0.0414	0.0732	0.4652
Oxbird/SD	1192.5	5	0.281	1.266	0.0145	0.0153	0.0181	0.0415	0.0732	0.4609
Bunting/SD	1192.5	7	0.326	1.284	0.0144	0.0152	0.0180	0.0423	0.0727	0.4588
Grackle/SD	1192.5	13	0.446	1.274	0.0143	0.0149	0.0177	0.0428	0.0724	0.4599
Scissortail/SD	1272	5	0.290	1.305	0.0136	0.0144	0.0170	0.0427	0.0725	0.4562
Bittern/SD	1272	7	0.336	1.323	0.0135	0.0143	0.0170	0.0436	0.0720	0.4541
Pheasant/SD	1272	13	0.461	1.378	0.0134	0.0141	0.0167	0.0464	0.0705	0.4477
Ringdove/SD	1351.5	5	0.299	1.344	0.0128	0.0136	0.0180	0.0440	0.0718	0.4514
Dipper/SD	1351.5	7	0.347	1.361	0.0128	0.0135	0.0160	0.0449	0.0713	0.4493
Frigate/SD	1351.5	10	0.413	1.389	0.0127	0.0134	0.0159	0.0463	0.0706	0.4462
Martin/SD	1351.5	13	0.475	1.417	0.0126	0.0133	0.0158	0.0477	0.0699	0.4430
Popinjay/SD	1431	5	0.308	1.381	0.0121	0.0129	0.0152	0.0452	0.0711	0.4472
Bobolink/SD	1431	7	0.357	1.398	0.0120	0.0128	0.0152	0.0461	0.0707	0.4451
Plover/SD	1431	13	0.489	1.448	0.0120	0.0127	0.0150	0.0488	0.0694	0.4398
Ratite/SD	1590	5	0.325	1.447	0.0109	0.0118	0.0138	0.0477	0.0699	0.4382
Lapwing/SD	1590	7	0.376	1.468	0.0108	0.0116	0.0137	0.0484	0.0696	0.4377
Falcon/SD	1590	13	0.515	1.521	0.0108	0.0115	0.0136	0.0512	0.0683	0.4319
Smew/SD	1780	5	0.343	1.531	0.0097	0.0106	0.0125	0.0502	0.0688	0.4308
Chukar/SD	1780	8	0.437	1.565	0.0097	0.0105	0.0124	0.0519	0.0680	0.4277
Cockatoo/SD	2156	5	0.378	1.731	0.0080	0.0091	0.0105	0.0573	0.0657	0.4118
Bluebird/SD	2156	8	0.481	1.716	0.0080	0.0089	0.0104	0.0570	0.0658	0.4134
Kiwi/SD	2167	4	0.347	1.725	0.0080	0.0090	0.0105	0.0570	0.0659	0.4124

(1) Code words shown denote ACSR/SD with regular-strength Class A galvanized steel core (GA2). See the Options section to find the appropriate code word modifier designation for alternative design options.
 (4) Based on a conductivity of 61.0% IACS at 20°C for aluminum and 8% IACS at 20°C for the steel core. AC resistance for three-layer designs must be increased by 1.1%, 2.7%, 3.7%, and 4.3% for current densities of 200, 600, 1000, and 1400 amperes per 1000 kcmil of aluminum to allow for the magnetic losses in the steel core. To convert to ohms/mile, multiply by 5.28. To convert to ohms/km, multiply by 3.281.
 (5) Values for inductive reactance and capacitive reactance are expressed in terms of a 1 ft radius.



Notes

TransPowr® ACCC®/TW Bare Overhead Conductor

Trapezoidal Aluminum Conductor, Composite Core - Concentric-Lay-Stranded

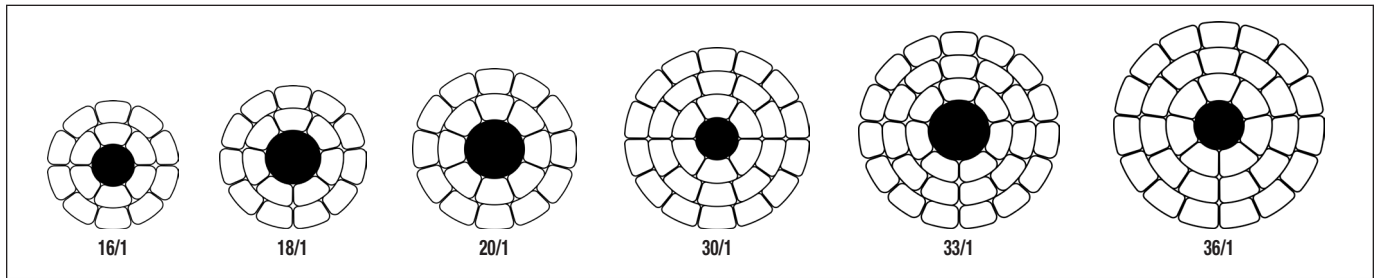

Product Construction:

Complete Conductor:

TransPowr® ACCC®/TW is an aluminum conductor composite core trapezoidal concentric-lay-stranded conductor. The aluminum strands are trapezoidal in shape and enable a more compact placement of the aluminum strand wires. ACCC/TW conductors are designed to maintain the same overall diameter as a conventional round wire ACSR. The compact trapezoidal conductors, coupled with a smaller composite core, result in a TW conductor that has approximately 28% more aluminum cross-sectional area than ACSR.

The design features follow the applicable requirements of ASTM B857 (Shaped Wire Compact Concentric-Lay-Stranded Aluminum Conductors, Coated-Steel Supported (ACSS/TW)). The annealed aluminum strand wires are in accordance to ASTM B609. The composite core strength member is a proprietary high-strength carbon and glass fiber composite core in accordance to ASTM B987, around which are stranded two, three or four layers of the annealed 1350 aluminum wires.

Features and Benefits:

- Doubles the current carrying capacity over conventional ACSR. This can allow a utility to re-conductor existing pathways without structural modifications.
- Can be operated to 180°C versus the existing ACSR with its conventional 75°C limit.
- The composite core has a very low thermal expansion coefficient and as such virtually eliminates high-temperature sag problems.
- The conductor is not affected by long-term creep of the aluminum. The high temperature sag limits are controlled by the composite core.
- The overall mass (weight) of the ACCC/TW conductor, even with the increased aluminum content, can be lighter than the original ACSR conductor it is replacing.
- Uses conventional installation methods and tools familiar to transmission line construction crews.
- May reduce construction costs by allowing the use of fewer support structures. The conductor's higher strength allows longer spans.
- The composite core resists environmental degradation. It will not rust, corrode or cause electrolysis with aluminum conductors or other components.
- With the higher aluminum content, it can offer higher operating efficiencies to help decrease power generation and transmission costs.

Applications:

TransPowr ACCC/TW conductors have been specifically designed for overhead power distribution and transmission lines and are especially useful in re-conducting applications requiring minimal thermal sag without structure modifications.

Options:

- E3X® surface coating (/E3X)
- Non-Specular surface finish (/NS)
- ULS - Extra High Strength composite carbon fiber core enabling greater strength and lower sag due to ice for use in locations where heavy or extreme ice loading conditions exist (ULS ACCC).

For more information, or information on other conductor sizes, designs and/or specific installation requirements not shown in the tables, contact your General Cable sales representative or e-mail infoca@generalcable.com.

ACCC is a registered trademark of CTC Global Corporation.



TransPowr® ACCC®/TW Bare Overhead Conductor

Trapezoidal Aluminum Conductor, Composite Core - Concentric-Lay-Stranded

TRAPEZOIDAL ALUMINUM CONDUCTOR, COMPOSITE CORE, CONCENTRIC-LAY-STRANDED (MECHANICAL PROPERTIES)												
CODE WORD (FORMER CODE WORD) (1)	SIZE kcmil	EQUIVALENT ACSR SIZE kcmil	NO. AL WIRES	COMPOSITE CORE O.D. INCHES	CROSS SECTION SQ. INCHES		O.D. INCHES	APPROX. WEIGHT LBS/1000 FT (2)			RATED STRENGTH LBS	
					TOTAL	AL		TOTAL	AL	CORE	STANDARD	ULS
Oceanside/ACCC/TW (Ostrich/ACCC/TW)	383	300	18	0.235	0.3443	0.3009	0.68	395	360	35	16000	—
Linnet/ACCC/TW	430	336.4	16	0.235	0.3816	0.3382	0.72	439	404	35	16300	—
Oriole/ACCC/TW	439	336.4	18	0.280	0.4062	0.3447	0.74	462	412	50	22100	—
Waco/ACCC/TW	454	—	18	0.305	0.4296	0.3565	0.77	485	427	59	25800	—
Laredo/ACCC/TW	530	—	16	0.280	0.4778	0.4162	0.81	547	498	50	22700	—
Irving/ACCC/TW	609	—	18	0.345	0.5721	0.4786	0.88	648	573	75	33200	39000
Hawk/ACCC/TW	611	477	16	0.280	0.5414	0.4798	0.86	623	573	50	23200	—
Dove/ACCC/TW	714	556.5	18	0.305	0.6334	0.5603	0.93	729	670	59	27400	—
Grosbeak/ACCC/TW	821	636	18	0.320	0.7254	0.6450	0.99	836	771	65	30400	—
Lubbock/ACCC/TW	904	—	18	0.345	0.8035	0.7100	1.04	924	849	75	35100	40800
Galveston/ACCC/TW	1011	—	18	0.345	0.8876	0.7941	1.09	1024	949	75	35700	41500
Drake/ACCC/TW	1026	795	18	0.375	0.9159	0.8055	1.11	1052	963	89	41100	48000
Curlew/ACCC/TW	1053	1033.5	20	0.415	0.9626	0.8273	1.14	1099	990	109	49100	57500
Plano/ACCC/TW	1059	—	33	0.345	0.9258	0.8323	1.13	1074	999	75	36100	41800
Corpus Christi/ACCC/TW	1103	—	33	0.345	0.9596	0.8661	1.15	1115	1040	75	36300	42100
Arlington/ACCC/TW	1151	—	33	0.375	1.0144	0.9040	1.18	1173	1084	89	41900	48800
Cardinal/ACCC/TW	1222	954	33	0.345	1.0529	0.9594	1.20	1224	1149	75	37100	42900
Fort Worth/ACCC/TW	1300	—	33	0.375	1.1317	1.0212	1.24	1312	1223	89	42900	49800
El Paso/ACCC/TW	1350	—	33	0.345	1.1536	1.0601	1.25	1344	1269	75	37900	43700
Beaumont/ACCC/TW	1429	—	33	0.375	1.2328	1.1224	1.30	1436	1347	89	43700	50600
San Antonio/ACCC/TW	1475	—	33	0.385	1.2747	1.1583	1.32	1484	1390	94	45900	53100
Bittern/ACCC/TW	1582	1272	33	0.345	1.3365	1.2431	1.34	1567	1491	75	39400	45200
Dallas/ACCC/TW	1795	—	33	0.385	1.5259	1.4095	1.43	1785	1691	94	47900	55200
Houston/ACCC/TW	1927	—	33	0.415	1.6406	1.5054	1.50	1915	1806	109	54700	63100
Lapwing/ACCC/TW	1949	1590	33	0.385	1.6469	1.5304	1.49	1930	1836	94	48900	56100
Falcon/ACCC/TW	2045	1590	36	0.415	1.7409	1.6056	1.53	2037	1928	109	55400	63800
Chukar/ACCC/TW	2242	1780	33	0.395	1.8841	1.7615	1.59	2212	2113	99	52700	60300
Chukar II/ACCC/TW	2606	1780	30	0.395	2.1689	2.0463	1.70	2555	2456	99	55000	62600
Bluebird/ACCC/TW	2741	2156	33	0.415	2.2880	2.1527	1.75	2691	2582	109	59900	68300

(1) Code words shown denote ACCC/TW with standard composite core. See the Options section to find the appropriate code word modifier designation for alternative design options (e.g., /E3X or /NS). Use the "ULS" prefix (e.g., ULS Drake/ACCC) to denote ULS ACCC designs.

(2) Due to rounding, total values may not exactly equal the sum of the component values.

Dimensions and weights not designated minimum or maximum are nominal values and subject to manufacturing tolerances. In this context, weight means mass.

TransPowr® ACCC® /TW Bare Overhead Conductor

Trapezoidal Aluminum Conductor, Composite Core - Concentric-Lay-Stranded

TRAPEZOIDAL ALUMINUM CONDUCTOR, COMPOSITE CORE, CONCENTRIC-LAY-STRANDED (ELECTRICAL PROPERTIES)

CODE WORD (FORMER CODE WORD) (1)	SIZE kcmil	O.D. INCHES	RESISTANCE (3) OHMS/1000 FT			AMPACITY @ 75°C (4)		AMPACITY @ 180°C (4)		GEOMETRIC MEAN RADIUS FT	INDUCTIVE REACTANCE OHMS/1000 FT (5)	CAPACITIVE REACTANCE MEGAOHMS/1000 FT (5)
			DC @ 20°C	AC @ 25°C	AC @ 75°C	STANDARD	E3X	STANDARD	E3X			
Oceanside/ACCC/TW (Ostrich/ACCC/TW)	383	0.680	0.0439	0.0449	0.0541	555	620	935	1035	0.0231	0.0866	0.5582
Linnet/ACCC/TW	430	0.720	0.0390	0.0400	0.0481	600	670	1005	1120	0.0243	0.0854	0.5492
Oriole/ACCC/TW	439	0.741	0.0383	0.0393	0.0472	610	685	1025	1140	0.0254	0.0844	0.5448
Waco/ACCC/TW	454	0.770	0.0371	0.0380	0.0457	625	705	1055	1175	0.0265	0.0834	0.5388
Laredo/ACCC/TW	530	0.808	0.0317	0.0326	0.0392	685	770	1155	1290	0.0274	0.0827	0.5313
Irving/ACCC/TW	609	0.882	0.0276	0.0284	0.0341	750	850	1275	1425	0.0303	0.0804	0.5174
Hawk/ACCC/TW	611	0.857	0.0275	0.0283	0.0340	745	845	1265	1410	0.0290	0.0814	0.5219
Dove/ACCC/TW	714	0.927	0.0236	0.0243	0.0292	820	935	1400	1565	0.0313	0.0796	0.5097
Grosbeak/ACCC/TW	821	0.990	0.0205	0.0212	0.0254	895	1020	1530	1720	0.0333	0.0782	0.4995
Lubbock/ACCC/TW	904	1.04	0.0186	0.0193	0.0231	950	1085	1630	1835	0.0351	0.0770	0.4917
Galveston/ACCC/TW	1011	1.09	0.0166	0.0174	0.0208	1015	1165	1750	1970	0.0367	0.0760	0.4841
Drake/ACCC/TW	1026	1.11	0.0164	0.0171	0.0205	1030	1180	1770	1995	0.0375	0.0755	0.4818
Curlew/ACCC/TW	1053	1.14	0.0160	0.0167	0.0199	1050	1205	1810	2040	0.0387	0.0747	0.4778
Plano/ACCC/TW	1059	1.13	0.0159	0.0167	0.0199	1045	1200	1805	2035	0.0380	0.0752	0.4790
Corpus Christi/ACCC/TW	1103	1.15	0.0153	0.0161	0.0192	1070	1230	1850	2090	0.0386	0.0748	0.4763
Arlington/ACCC/TW	1151	1.18	0.0147	0.0154	0.0184	1100	1270	1905	2155	0.0398	0.0741	0.4723
Cardinal/ACCC/TW	1222	1.20	0.0138	0.0146	0.0174	1140	1310	1975	2235	0.0402	0.0739	0.4695
Fort Worth/ACCC/TW	1300	1.24	0.0130	0.0137	0.0164	1185	1365	2055	2330	0.0417	0.0730	0.4641
El Paso/ACCC/TW	1350	1.25	0.0125	0.0133	0.0158	1210	1395	2100	2380	0.0418	0.0730	0.4626
Beaumont/ACCC/TW	1429	1.30	0.0118	0.0126	0.0150	1250	1445	2180	2475	0.0434	0.0721	0.4575
San Antonio/ACCC/TW	1475	1.32	0.0115	0.0123	0.0146	1275	1475	2225	2525	0.0441	0.0717	0.4549
Bittern/ACCC/TW	1582	1.34	0.0107	0.0116	0.0137	1325	1535	2315	2635	0.0448	0.0714	0.4513
Dallas/ACCC/TW	1795	1.43	0.00941	0.0104	0.0122	1426	1660	2510	2860	0.0479	0.0698	0.4413
Houston/ACCC/TW	1927	1.50	0.00881	0.00978	0.0115	1485	1735	2625	3000	0.0502	0.0688	0.4342
Lapwing/ACCC/TW	1949	1.49	0.00866	0.00967	0.0113	1495	1740	2640	3015	0.0496	0.0690	0.4355
Falcon/ACCC/TW	2045	1.53	0.00826	0.00928	0.0109	1535	1795	2725	3115	0.0511	0.0683	0.4310
Chukar/ACCC/TW	2242	1.59	0.00753	0.00864	0.0101	1615	1890	2875	3290	0.0528	0.0676	0.4252
Chukar II/ACCC/TW	2606	1.70	0.00648	0.00773	0.00892	1745	2055	3140	3605	0.0564	0.0661	0.4146
Bluebird/ACCC/TW	2741	1.75	0.00616	0.00743	0.00856	1795	2115	3240	3725	0.0579	0.0655	0.4103

(1) Code words shown denote ACCC/TW with standard composite core. See the Options section to find the appropriate code word modifier designation for alternative design options (e.g., /E3X or /NS). Use the "ULS" prefix (e.g., ULS Drake/ACCC) to denote ULS ACCC designs.
 (3) Based on a conductivity of 63.0% IACS at 20°C for aluminum and ignores the effects of the composite core. To convert to ohms/mile, multiply by 5.28. To convert to ohms/km, multiply by 3.281.
 (4) Based on the following conditions, 60 Hz, 25°C ambient temperature, 2 ft/sec crosswind (90° to conductor), 0.5 coefficient of emissivity for a standard conductor and 0.9 for a E3X coated conductor, 0.5 coefficient of absorptivity for a standard conductor and 0.2 for a E3X coated conductor, 30° northern latitude, sea level elevation, 90° azimuth of line (East-West), clear atmosphere, and a date and time of noon on July 1 (resulting in 96.0 W/ft² of solar and sky radiated heat). Actual ampacity will differ based on local conditions. For specific ampacities, please contact your General Cable sales representative.
 (5) Values for inductive reactance and capacitive reactance are expressed in terms of a 1 ft radius.
 Dimensions and weights not designated minimum or maximum are nominal values and subject to manufacturing tolerances. In this context, weight means mass.



Notes

Covered Overhead Conductor — Line Wire

Single Conductor LLDPE or XLPE Covered Line Wire



Product Construction:

Complete Cable:

Weatherproof line wire consists of single conductor covered with either Linear Low-Density Polyethylene (LLDPE) or Cross-linked Polyethylene (XLPE). Conductors may be compact or concentric strand of ACSR, A1 or A2 or solid, compact or concentric strand copper. Weatherproof line wire meets the requirements of CSA C68.9 and the ANSI/ICEA S-70-547 specification, as applicable.

Conductors:

Different conductor types are available. Solid or stranded MHD copper, compact or concentric HD aluminum, aluminum alloy, or ACSR are all options that are available.

The conductors meet the requirements of CSA C49.2, CAN/CSA C61089, ASTM B3, B8, B231, B232, B400, or B496 as applicable. For aluminum and ACSR conductors, the direction of lay of the outer layer of the strand is right-hand. For copper conductors, the direction of lay of the outer layer of the strand is left-hand.

For products manufactured with aluminum conductors, the product is available with conductor corrosion-resistant inhibitor treatment.

Complete Cable (cont'd.):

Covering:

Black, Linear Low-Density Polyethylene (LLDPE) or black extruded Cross-linked Polyethylene (XLPE) coverings are available.

There is no voltage rating.

Features and Benefits:

The covering provides mechanical protection to the conductor and is resistant to weathering and chemicals. If the conductors accidentally come into contact due to high winds, falling tree limbs, or other disturbances, the covering resists short circuits and the tendency for conductors to weld together.

Applications:

Weatherproof line wire is used for overhead transmission and distribution lines. Covered line wire is not an electrically insulated cable. Therefore, it should be installed on insulators, and users should treat line wire as bare conductor for personal safety.

Options:

- Medium-Density Polyethylene (MDPE)
- High-Density Cross-linked Polyethylene (HDXLPE)
- Annealed (soft drawn) copper for transformer drop and covered ground wire
- Conductor corrosion-resistant inhibitor treatment
- Sequential print marking

For other conductor sizes, designs and/or specific installation requirements not shown in the tables, contact your General Cable sales representative or e-mail infoca@generalcable.com.



Covered Overhead Conductor — Line Wire

Single Conductor LLDPE or XLPE Covered Line Wire

COVERED ACSR ALUMINUM CONDUCTOR, STEEL-REINFORCED, COMPACT-LAY-STRANDED

CODE WORD (1)	CONDUCTOR SIZE		NO. OF WIRES	CONDUCTOR O.D. (mm)	COVER THKN. (mm)	CABLE O.D. (mm)	NOMINAL MASS KG/KM			RATED STRENGTH kN	AMPACITY	
	AWG or kcmil	mm ²					AL	TOTAL			PE (2)	XLPE (3)
								PE	XLPE			
Gum	#6	13.3	6/1	4.62	0.76	6.15	36.5	67.1	67.1	5.19	95	110
Solah	#6	13.3	6/1	4.90	0.76	6.43	36.5	85.3	85.3	7.67	95	115
-none-	#6	13.3	6/1	5.28	0.76	6.81	36.5	106.9	106.9	10.7	100	120
Teak	#4	21.2	6/1	5.82	0.76	7.34	57.7	102.4	102.4	8.15	125	145
-none-	#4	21.2	6/1	6.17	0.76	7.70	57.7	131.0	131.0	12.1	130	155
-none-	#4	21.2	6/1	6.71	0.76	8.23	57.7	164.9	164.9	16.4	130	160
Ebony	#2	33.6	6/1	7.37	1.14	9.65	92.0	167.9	167.9	12.4	160	190
-none-	#2	33.6	6/1	7.82	1.14	10.1	92.0	215.6	215.6	18.4	170	205
-none-	#2	33.6	6/1	8.41	1.14	10.7	92.0	268.0	268.0	25.7	175	210
Liana	#1	42.4	6/1	8.28	1.14	10.6	116.3	207.6	207.6	15.5	185	220
-none-	#1	42.4	6/1	8.79	1.14	11.1	116.3	265.2	265.2	23.0	195	240
Bamboo	1/0	53.5	6/1	9.27	1.52	12.3	146.6	267.1	267.1	18.9	210	250
-none-	1/0	53.5	6/1	9.86	1.52	12.9	146.6	339.8	339.8	28.8	225	275
Corypha	2/0	67.4	6/1	10.4	1.52	13.5	185.0	329.2	329.2	23.5	240	290
Mahogany	3/0	85.0	6/1	11.7	1.52	14.8	232.9	407.0	407.0	29.6	275	325
Eucalyptus	4/0	107.2	6/1	13.1	1.52	16.2	293.7	504.1	504.1	37.3	310	370
-none-	266.8	135.2	18/1	14.2	1.52	17.2	372.1	503.0	503.0	31.2	385	425
-none-	336.4	170.5	18/1	16.0	1.52	19.0	470.3	623.0	623.0	39.4	445	550

COVERED ACSR ALUMINUM CONDUCTOR, STEEL-REINFORCED, CONCENTRIC-LAY-STRANDED

CODE WORD (1)	CONDUCTOR SIZE		NO. OF WIRES	CONDUCTOR O.D. (mm)	COVER THKN. (mm)	CABLE O.D. (mm)	NOMINAL MASS KG/KM			RATED STRENGTH kN	AMPACITY	
	AWG or kcmil	mm ²					AL	TOTAL			PE (2)	XLPE (3)
								PE	XLPE			
Walnut	#6	13.3	6/1	5.04	0.762	6.60	36.5	69.8	69.8	5.19	95	115
Butternut	#4	21.1	6/1	6.36	0.762	7.92	57.7	106.1	106.1	8.14	125	150
Hickory	#4	21.1	7/1	6.53	0.762	8.10	57.7	121.1	121.1	10.2	125	150
Pignut	#2	33.6	6/1	8.01	1.14	10.3	92.0	174.4	174.4	12.4	165	195
Chestnut	#1	42.4	6/1	9.00	1.14	11.3	116.3	214.1	214.1	15.5	190	225
Almond	1/0	53.5	6/1	10.1	1.52	13.1	146.6	274.6	274.6	18.9	215	255
Pecan	2/0	67.4	6/1	11.3	1.52	14.3	185.0	337.7	337.7	23.5	245	295
Filbert	3/0	85	6/1	12.8	1.52	15.7	232.9	416.8	416.8	29.6	280	335
Buckeye	4/0	107.2	6/1	14.3	1.52	17.3	293.7	515.7	515.7	37.3	320	395
Hackberry	266.8	135.2	18/1	15.5	1.52	18.5	371.1	516.4	516.4	31.2	395	475
Redbud	266.8	135.2	18/1	15.5	2.03	19.6	371.1	546.2	546.2	31.2	395	475
Mockernut	336.4	170.5	18/1	17.4	1.52	20.4	470.3	640.0	640.0	39.6	455	545
Aspen	336.4	170.5	18/1	17.4	2.03	21.5	470.3	672.7	672.7	39.6	455	545

(1) Code words shown are for PE covered products. Add the suffix "/XLPE" to the code word name to identify the code word for XLPE products. Example Walnut/XLPE.

(2) The ampacity rating is based on a conductor temperature of 75°C at 60 Hz and the following conditions, 32°C ambient temperature, 1.98 ft/sec (0.6 m/sec) crosswind (90° to conductor), 0.91 coefficient of emissivity, 0.95 coefficient of absorptivity, 42° northern latitude, sea level elevation, 90° azimuth of line (East-West), clear atmosphere, and a date and time of noon on July 1 (resulting in 95.0 W/ft² of solar and sky radiated heat). Actual ampacity will differ based on local conditions. For specific ampacities, please contact your General Cable sales representative.

(3) The ampacity rating is based on a conductor temperature of 90°C at 60 Hz and the following conditions, 32°C ambient temperature, 1.98 ft/sec (0.6 m/sec) crosswind (90° to conductor), 0.91 coefficient of emissivity, 0.95 coefficient of absorptivity, 42° northern latitude, sea level elevation, 90° azimuth of line (East-West), clear atmosphere, and a date and time of noon on July 1 (resulting in 95.0 W/ft² of solar and sky radiated heat). Actual ampacity will differ based on local conditions. For specific ampacities, please contact your General Cable sales representative.

Dimensions and weights not designated minimum or maximum are nominal values and subject to manufacturing tolerances. In this context, weight means mass.



Covered Overhead Conductor — Line Wire

Single Conductor LLDPE or XLPE Covered Line Wire

COVERED ASC ALUMINUM CONDUCTOR, CONCENTRIC-LAY-STRANDED

CODE WORD (1)	CONDUCTOR SIZE		NO. OF WIRES	CONDUCTOR O.D. (mm)	COVER THKN. (mm)	CABLE O.D. (mm)	NOMINAL MASS KG/KM (2)			RATED STRENGTH kN	AMPACITY	
	AWG or kcmil	mm ²					AL	TOTAL			PE (2)	XLPE (3)
								PE	XLPE			
Apple	#6	13.3	1	4.11	0.76	5.69	36.5	49.7	49.7	2.18	95	110
Plum	#6	13.3	7	4.68	0.76	6.22	36.5	51.5	51.5	2.61	95	110
Pear	#4	21.1	1	5.19	0.76	6.76	57.7	74.9	74.9	3.47	125	150
Apricot	#4	21.1	7	5.88	0.76	7.44	57.7	77.4	77.4	4.12	125	150
Cherry	#2	33.6	1	6.54	1.14	8.89	92.0	123.8	123.8	5.38	165	200
Peach	#2	33.6	7	7.41	1.14	9.75	92.0	128.1	128.1	6.21	165	200
Nectarine	#1	42.4	7	8.34	1.14	10.7	116.3	157.0	157.0	7.44	185	215
Quince	1/0	53.5	7	9.36	1.52	12.5	146.6	201.7	201.7	9.10	220	260
Orange	2/0	67.4	7	10.5	1.52	13.6	185.0	246.4	246.4	11.4	260	310
Fig	3/0	85.0	7	11.8	1.52	14.9	232.9	302.3	302.3	14.0	295	350
Olive	4/0	107.2	7	13.3	1.52	16.4	293.7	371.0	371.0	17.7	340	405
Mulberry	266.8	135.2	19	15.1	1.52	18.2	372.1	456.9	456.9	23.0	390	470
Silverbelt	266.8	135.2	19	15.1	2.03	19.2	372.1	485.2	485.2	23.0	390	470
Anona	336.4	170.5	19	16.9	1.52	20.0	470.3	564.0	564.0	29.0	450	545
Crabapple	336.4	170.5	19	16.9	2.03	21.1	470.3	595.3	595.3	29.0	445	535
Chinquapin	350	177.4	19	17.3	1.52	20.4	488.7	584.9	584.9	30.2	460	555
Ginko	350	177.4	19	17.3	2.03	21.4	488.7	616.1	616.1	30.2	460	555
Moles	397.5	201.4	19	18.4	2.03	22.5	553.1	690.5	690.5	34.2	495	595
Ash	400	202.7	19	18.5	2.03	22.6	559.1	695.0	695.0	34.5	495	600
Huckleberry	477	241.7	37	20.2	2.03	24.4	665.5	815.5	815.5	42.2	555	670
Paw Paw	556.5	282.0	37	21.8	2.03	26.0	781.0	939.1	939.1	48.1	605	735
Breadfruit	636	322.3	61	23.3	2.41	28.3	891.1	1088	1088	57.8	650	790
Persimmon	795	402.8	61	26.1	2.41	31.0	1117	1333	1333	70.5	743	918
Grapefruit	1033.5	523.7	61	29.8	2.41	34.7	1455	1700	1700	89.2	800	980
Mango	1590	805.7	61	36.9	2.79	42.6	2233	2588	2588	133	1110	1370

COVERED ASC ALUMINUM CONDUCTOR, COMPACT-LAY-STRANDED

CODE WORD (1)	CONDUCTOR SIZE		NO. OF WIRES	CONDUCTOR O.D. (mm)	COVER THKN. (mm)	CABLE O.D. (mm)	NOMINAL MASS KG/KM (2)			RATED STRENGTH kN	AMPACITY	
	AWG or kcmil	mm ²					AL	TOTAL			PE (2)	XLPE (3)
								PE	XLPE			
Bay	#6	13.3	7	4.28	0.76	5.81	36.5	55.8	55.8	2.59	95	110
Hop	#4	21.1	7	5.41	0.76	6.93	57.7	82.0	82.0	4.12	125	145
Sloe	#2	33.6	7	6.81	1.14	9.10	92.0	121.7	121.7	6.22	165	195
Alder	#1	42.4	7	7.59	1.14	9.90	116.3	149.3	149.3	7.42	190	225
Aspen	1/0	53.5	7	8.53	1.52	11.6	146.6	193.6	193.6	9.10	215	255
Thorn	2/0	67.4	7	9.55	1.52	12.6	185.0	236.9	236.9	11.4	255	305
Barwood	3/0	85.0	7	10.7	1.52	13.8	232.9	291.2	291.2	14.0	285	340
Camwood	3/0	85.0	18	10.7	1.52	13.8	232.9	292.3	292.3	15.7	285	340
Dogwood	4/0	107.2	7	12.1	1.52	15.1	293.7	359.0	359.0	17.7	330	395
Oakwood	4/0	107.2	18	12.1	1.52	15.1	293.7	360.4	360.4	18.8	330	395
-none-	250	126.7	7	13.2	1.52	16.3	346.3	418.2	418.2	20.9	365	440
Redwood	266.8	135.2	7	13.6	1.52	16.7	371.1	440.5	440.5	22.2	385	460
Corkwood	266.8	135.2	18	13.6	1.52	16.7	372.1	442.0	442.0	22.3	385	460
Hornbeam	300	152.0	18	14.5	1.52	17.5	419.0	492.6	492.6	25.8	410	480
Ironwood	336.4	170.5	18	15.3	1.52	18.4	468.8	546.2	546.2	29.0	440	530
Beachwood	397.5	201.4	18	16.7	1.52	19.8	555.1	638.4	638.4	33.2	490	590
Buttonwood	477	241.7	18	18.3	2.03	22.4	665.2	790.2	790.2	39.9	540	650
-none-	500	253.4	18	18.7	2.03	22.8	698.0	824.5	824.5	41.8	555	670

(1) Code words shown are for PE covered products. Add the suffix "XLPE" to the code word name to identify the code word for XLPE products. Example Walnut/XLPE.
 (2) The ampacity rating is based on a conductor temperature of 75°C at 60 Hz and the following conditions, 32°C ambient temperature, 1.98 ft/sec (0.6 m/sec) crosswind (90° to conductor), 0.91 coefficient of emissivity, 0.95 coefficient of absorptivity, 42° northern latitude, sea level elevation, 90° azimuth of line (East-West), clear atmosphere, and a date and time of noon on July 1 (resulting in 95.0 W/ft² of solar and sky radiated heat). Actual ampacity will differ based on local conditions. For specific ampacities, please contact your General Cable sales representative.
 (3) The ampacity rating is based on a conductor temperature of 90°C at 60 Hz and the following conditions, 32°C ambient temperature, 1.98 ft/sec (0.6 m/sec) crosswind (90° to conductor), 0.91 coefficient of emissivity, 0.95 coefficient of absorptivity, 42° northern latitude, sea level elevation, 90° azimuth of line (East-West), clear atmosphere, and a date and time of noon on July 1 (resulting in 95.0 W/ft² of solar and sky radiated heat). Actual ampacity will differ based on local conditions. For specific ampacities, please contact your General Cable sales representative.
 Dimensions and weights not designated minimum or maximum are nominal values and subject to manufacturing tolerances. In this context, weight means mass.



Covered Overhead Conductor — Line Wire

Single Conductor LLDPE or XLPE Covered Line Wire

COVERED MHD COPPER CONDUCTOR, CONCENTRIC-LAY-STRANDED

CODE WORD (1)	CONDUCTOR SIZE		NO. OF WIRES	CONDUCTOR O.D. (mm)	COVER THKN. (mm)	CABLE O.D. (mm)	NOMINAL MASS KG/KM			RATED STRENGTH kN	AMPACITY	
	AWG OR kcmil	mm ²					CU	TOTAL			PE (2)	XLPE (3)
								PE	XLPE			
MEDIUM HARD DRAWN COPPER												
-none-	4	21.1	7	5.89	0.76	7.42	189.9	210.4	210.4	7.4	160	190
-none-	2	33.6	7	7.42	1.14	9.70	302.4	339.8	339.8	11.6	210	250
-none-	1/0	53.5	7	9.35	1.52	12.4	481.7	538.1	538.1	18.2	275	330
-none-	2/0	67.4	19	10.6	1.52	13.7	606.6	671.5	671.5	23.7	320	380
-none-	4/0	107.2	19	13.4	1.52	16.4	965.0	1048	1048	37.0	425	510

(1) Code words shown are for PE covered products. Add the suffix "/XLPE" to the code word name to identify the code word for XLPE products. Example Walnut/XLPE.

(2) The ampacity rating is based on a conductor temperature of 75°C at 60 Hz and the following conditions, 32°C ambient temperature, 1.98 ft/sec (0.6 m/sec) crosswind (90° to conductor), 0.91 coefficient of emissivity, 0.95 coefficient of absorptivity, 42° northern latitude, sea level elevation, 90° azimuth of line (East-West), clear atmosphere, and a date and time of noon on July 1 (resulting in 95.0 W/ft² of solar and sky radiated heat). Actual ampacity will differ based on local conditions. For specific ampacities, please contact your General Cable sales representative.

(3) The ampacity rating is based on a conductor temperature of 90°C at 60 Hz and the following conditions, 32°C ambient temperature, 1.98 ft/sec (0.6 m/sec) crosswind (90° to conductor), 0.91 coefficient of emissivity, 0.95 coefficient of absorptivity, 42° northern latitude, sea level elevation, 90° azimuth of line (East-West), clear atmosphere, and a date and time of noon on July 1 (resulting in 95.0 W/ft² of solar and sky radiated heat). Actual ampacity will differ based on local conditions. For specific ampacities, please contact your General Cable sales representative.

Dimensions and weights not designated minimum or maximum are nominal values and subject to manufacturing tolerances. In this context, weight means mass.



Covered Overhead Conductor — Tree Wire

Single Conductor Single or Dual Layer Covered Tree Wire

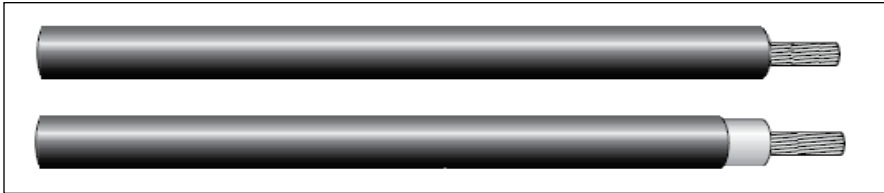

AAC - SINGLE LAYER TREE WIRE FOR 5 KV APPLICATIONS

SIZE (AWG OR kcmil)	STRANDING	COVERING THICKNESS (INCHES)	APPROX. CABLE OVERALL DIAMETER (INCHES)	APPROX. WEIGHT (LBS/1000 FT)	RATED STRENGTH (LBS)
4	7	0.080	0.385	73	792
2	7	0.080	0.443	104	1215
1/0	7	0.080	0.517	147	1791
2/0	7	0.080	0.562	178	2259
3/0	7	0.080	0.610	217	2736
4/0	7	0.080	0.666	265	3447
266.8	7	0.080	0.728	322	4347
266.8	19	0.080	0.734	323	4473
336.4	19	0.080	0.805	397	5535
397.5	19	0.080	0.861	461	6399
477	19	0.080	0.928	544	7524
477	37	0.080	0.931	545	7821

AAC - DUAL LAYER TREE WIRE FOR 15 KV APPLICATIONS

SIZE (AWG OR kcmil)	NO. OF WIRES	COVERING THICKNESS (INCHES)		APPROX. CABLE OVERALL DIAMETER (INCHES)	APPROX. WEIGHT (LBS/1000 FT)	RATED STRENGTH (LBS)
		INNER	OUTER			
#2	7	0.075	0.075	0.583	149	1215
1/0	7	0.075	0.075	0.657	199	1791
2/0	7	0.075	0.075	0.702	234	2259
3/0	7	0.075	0.075	0.750	277	2736
4/0	7	0.075	0.075	0.806	330	3447
266.8	7	0.075	0.075	0.868	393	4347
266.8	19	0.075	0.075	0.874	395	4473
336.4	19	0.075	0.075	0.945	475	5535
397.5	19	0.075	0.075	1.001	544	6399
477	19	0.075	0.075	1.068	633	7524
477	37	0.075	0.075	1.071	633	7821
556.5	37	0.075	0.075	1.132	721	8946
636	37	0.075	0.075	1.190	806	10260

Dimensions and weights not designated minimum or maximum are nominal values and subject to manufacturing tolerances. In this context, weight means mass.

Product Construction:

Complete Conductor:

Tree wire consists of a single conductor (AAC, AAAC or ACSR) covered with either a single layer of track resistant covering or a dual layer covering with a track resistant outer layer. Tree wire is manufactured to ICEA S-121-733.

Conductors:

- AAC – compressed stranding, 1350-H19 aluminum made to ASTM B231
- AAAC – concentric stranding, 6201-81 aluminum alloy made to ASTM B399
- ACSR – concentric stranding, 1350-19 aluminum with GA2 steel core made to ASTM B232

Coverings:

Single Layer:

- TR-HDPE – Black Track Resistant High Density Polyethylene
- TR-HDXLPE – Black Track Resistant Cross-Linked Polyethylene

Dual Layer:

- LLDPE/TR-HDPE - Linear Low Density Polyethylene/Black Track Resistant High Density Polyethylene
- XLPE/TR-HDXLPE - Cross-Linked Polyethylene/Black Track Resistant Cross-Linked Polyethylene

Features and Benefits:

Covering protects against faults due to contact.

Applications:

For areas with overhead power lines that have a potential for contact with trees or other debris.

Options:

- Gray colored HDXLPE or XLPE

For more information, or information on other conductor sizes, designs or specific installation requirements not shown in the tables, contact your General Cable sales representative or e-mail us at infoca@generalcable.com.

Covered Overhead Conductor — Tree Wire

Single Conductor Single or Dual Layer Covered Tree Wire

AAAC - SINGLE LAYER TREE WIRE FOR 5 kV APPLICATIONS						
SIZE (kcmil)	EQUIVALENT SIZE (AWG OR kcmil)	NO. OF WIRES	COVERING THICKNESS (INCHES)	APPROX. CABLE OVERALL DIAMETER (INCHES)	APPROX. WEIGHT (LBS/1000 FT)	RATED STRENGTH (LBS)
48.69	4	7	0.080	0.410	83	1584
77.47	2	7	0.080	0.476	118	2520
123.3	1/0	7	0.080	0.558	168	3852
155.4	2/0	7	0.080	0.607	204	4851
195.7	3/0	7	0.080	0.662	248	6111
246.9	4/0	7	0.080	0.723	304	7704
312.8	266.8	19	0.080	0.802	373	9450
394.5	336.4	19	0.080	0.880	459	11970
465.4	397.5	19	0.080	0.943	533	14040
559.5	477	19	0.080	1.018	631	16920

AAAC - DUAL LAYER TREE WIRE FOR 15 kV APPLICATIONS							
SIZE (kcmil)	EQUIVALENT SIZE (AWG OR kcmil)	NO. OF WIRES	COVERING THICKNESS (INCHES)		APPROX. CABLE OVERALL DIAMETER (INCHES)	APPROX. WEIGHT (LBS/1000 FT)	RATED STRENGTH (LBS)
			INNER	OUTER			
48.69	4	7	0.075	0.075	0.550	126	1584
77.47	2	7	0.075	0.075	0.616	167	2520
123.3	1/0	7	0.075	0.075	0.698	224	3852
155.4	2/0	7	0.075	0.075	0.747	264	4851
195.7	3/0	7	0.075	0.075	0.802	313	6111
246.9	4/0	7	0.075	0.075	0.863	374	7704
312.8	266.8	19	0.075	0.075	0.942	450	9450
394.5	336.4	19	0.075	0.075	1.020	543	11970
465.4	397.5	19	0.075	0.075	1.083	623	14040
559.5	477	19	0.075	0.075	1.158	727	16920
652.4	556.5	19	0.080	0.080	1.227	825	19710
740.8	636	37	0.080	0.080	1.290	922	21960
927.2	795	37	0.080	0.080	1.408	1121	27450

Dimensions and weights not designated minimum or maximum are nominal values and subject to manufacturing tolerances. In this context, weight means mass.

Covered Overhead Conductor — Tree Wire

Single Conductor Single or Dual Layer Covered Tree Wire

ACSR - SINGLE LAYER TREE WIRE FOR 5 KV APPLICATIONS

SIZE (AWG OR kcmil)	NO. OF WIRES	COVERING THICKNESS (INCHES)	APPROX. CABLE OVERALL DIAMETER (INCHES)	APPROX. WEIGHT (LBS/1000 FT)	RATED STRENGTH (LBS)
2	6/1	0.080	0.476	137	2708
1/0	6/1	0.080	0.558	198	4161
2/0	6/1	0.080	0.607	242	5035
3/0	6/1	0.080	0.662	297	6289
4/0	6/1	0.080	0.723	365	7933
266.8	18/1	0.080	0.769	367	6536
266.8	26/7	0.080	0.802	448	10735
336.4	18/1	0.080	0.844	451	8246
336.4	26/7	0.080	0.880	553	13395
336.4	30/7	0.080	0.901	620	16435
397.5	18/1	0.080	0.903	525	9443
397.5	24/7	0.080	0.932	609	13870
397.5	26/7	0.080	0.943	645	15485
477	18/1	0.080	0.974	620	11210
477	24/7	0.080	1.006	721	16340
477	26/7	0.080	1.018	764	18525
477	30/7	0.080	1.043	858	22610

ACSR - DUAL LAYER TREE WIRE FOR 15 KV APPLICATIONS

SIZE (AWG OR kcmil)	NO. OF WIRES	COVERING THICKNESS (INCHES)		APPROX. CABLE OVERALL DIAMETER (INCHES)	APPROX. WEIGHT (LBS/1000 FT)	RATED STRENGTH (LBS)
		INNER	OUTER			
2	6/1	0.075	0.075	0.616	186	2708
1/0	6/1	0.075	0.075	0.698	254	4161
2/0	6/1	0.075	0.075	0.747	302	5035
3/0	6/1	0.075	0.075	0.802	362	6289
4/0	6/1	0.075	0.075	0.863	435	7933
266.8	18/1	0.075	0.075	0.909	441	6536
266.8	26/7	0.075	0.075	0.942	525	10735
336.4	18/1	0.075	0.075	0.982	532	8246
336.4	26/7	0.075	0.075	1.020	638	13395
336.4	30/7	0.075	0.075	1.041	706	16435
397.5	18/1	0.075	0.075	1.043	611	9443
397.5	24/7	0.075	0.075	1.072	698	13870
397.5	26/7	0.075	0.075	1.083	735	15485
477	18/1	0.075	0.075	1.114	713	11210
477	24/7	0.075	0.075	1.146	816	16340
477	26/7	0.075	0.075	1.158	861	18525
477	30/7	0.075	0.075	1.183	957	22610
556.5	18/1	0.075	0.075	1.179	813	13015
556.5	24/7	0.075	0.075	1.214	933	18810
556.5	26/7	0.075	0.075	1.227	986	21470
636	18/1	0.075	0.075	1.240	910	14915
636	24/7	0.075	0.075	1.277	1046	21470
636	26/7	0.075	0.075	1.290	1105	23940
795	45/7	0.080	0.080	1.383	1159	20995
795	24/7	0.080	0.080	1.412	1294	26505
795	26/7	0.080	0.080	1.427	1367	29925

Dimensions and weights not designated minimum or maximum are nominal values and subject to manufacturing tolerances.
In this context, weight means mass.

Aluminum Tie Wire

Soft Solid 1350 Aluminum Wire

Product Construction:

Description:

Aluminum tie wire is a soft solid aluminum wire that is used in overhead transmission and distribution line construction to mechanically secure components such as conductors to pin insulators. The wire is also used for above-ground grounding applications in line construction.

Aluminum tie wire is a solid annealed (soft) aluminum wire manufactured to CSA C49.3 "0" tensile grade and wire diameter dimension.

Options:

Tie wire may be supplied with a black weather-resistant covering. The nominal thickness of this extruded covering is 30 mils.

Packaging:

Aluminum tie wire is sold in coils.

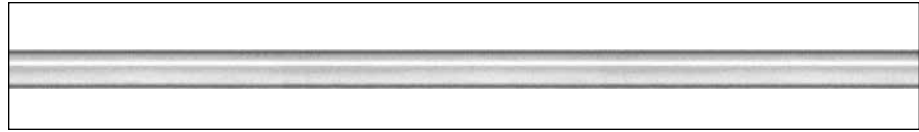

SIZE AWG	DIAMETER OF SOLID WIRE (mm)	NOMINAL MASS KG/KM	NOMINAL BREAKING STRENGTH kN
6	4.11	35.9	0.78
4	5.19	57.1	1.24
2	6.54	90.7	1.97

Based on annealed aluminum having a minimum tensile strength of 60 MPa.
Dimensions and weights not designated minimum or maximum are nominal values and subject to manufacturing tolerances. In this context, weight means mass.

Miscellaneous Products

5

General Cable manufactures a wide range of wire and cable products. The following section provides information on some of the common conductor or cable items that are consumed in the electric utility marketplace. While some of the following catalog pages may be found in other General Cable catalogs or brochures, the information is provided to facilitate easier access to the material.

General Cable provides technical assistance and advice on any challenges associated with conductor or cable design, installation or application. Engineering services are available for specification review, specification development and conductor application inquiries.

For more information, contact a General Cable sales representative or e-mail infoca@generalcable.com.

Index	Page
Bare Soft Copper Grounding Conductor	136
DSA CCS Copper Clad Steel Grounding Conductor	137
Steel Overhead Ground Wire and Steel Guy Wire	138
600 V RW90 NUAL® Brand Aluminum Insulated Conductors	139
600 V RW90 Copper Insulated Conductors	140
1000 V RWU90 NUAL® Brand Aluminum Insulated Conductors	141
1000 V RWU90 Copper Insulated Conductors	142



Bare Soft Copper Grounding Conductor

Product Construction:

Complete Conductor:

Bare soft copper grounding conductors are solid or concentric-lay-stranded, consisting of one or more layers of wire wrapped helically around a straight round central wire. Each successive layer has six wires more than the layer immediately beneath. Greater flexibility is afforded by using Class B stranding. The direction of lay for the outer layer is left-hand lay. In multilayer constructions, the direction of lay for each successive layer is reversed. Copper ground wires are manufactured using annealed soft copper wire and are manufactured in accordance with the requirements of the latest applicable issues of the ASTM specifications B3 and B8.

Features and Benefits:

Solid or stranded bare soft copper grounding conductors are suitable for direct burial and are inherently corrosion-resistant and easy to terminate and join at splices and joints.

Applications:

Solid and stranded bare soft copper grounding conductors are suitable for use as neutrals, as circuit grounding conductors as well as machinery and equipment grounding systems. Soft copper may be used for transformer drop leads or other non-tension hook-up jumpers.

For more information, or information on other conductor sizes, designs or specific installation requirements not shown in the tables, contact your General Cable sales representative or e-mail us at infoca@generalcable.com.

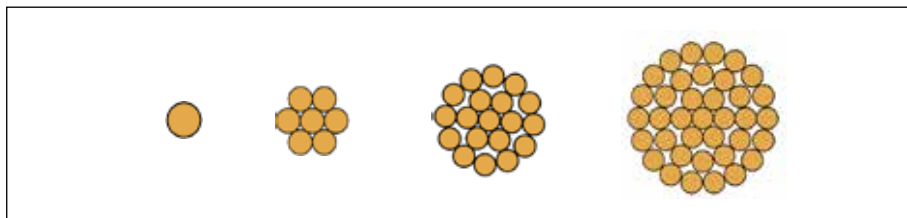

CONCENTRIC-LAY-STRANDED BARE SOFT COPPER GROUNDING CONDUCTORS

SIZE (AWG or kcmil)	NO. OF WIRES	OVERALL DIAMETER (INCHES)	RESISTANCE DC @ 20°C (OHMS/1000 FT)	APPROXIMATE WEIGHT (LBS/1000 FT)	STANDARD PACKAGES		
					WOOD REEL DESIGNATION	WEIGHT (POUNDS)	LENGTH (FT)
8	1	0.128	0.628	50	NH 30.18.10	650	11,500
6	1	0.162	0.395	79	NH 30.18.10	1,200	14,400
1/0	7	0.368	0.1002	326	NH 50.32.21	4,300	12,600
1/0	19	0.373	0.1003	326	NH 50.32.21	4,000	11,400
2/0	7	0.414	0.0795	411	NH 50.32.21	4,300	10,000
2/0	19	0.418	0.0795	411	NH 50.32.21	3,800	8,800
3/0	7	0.464	0.0630	518	NH 50.32.21	4,300	7,900
3/0	19	0.470	0.0630	518	NH 50.32.21	3,900	7,100
4/0	7	0.522	0.0499	653	NH 50.32.21	4,500	6,200
4/0	19	0.528	0.0500	653	NH 50.32.21	3,900	5,600
250	19	0.574	0.0423	772	NH 50.32.21	3,900	4,800
250	37	0.575	0.0423	772	NH 50.32.21	4,500	5,500
500	37	0.814	0.0212	1544	NH 50.32.21	4,500	2,800

Dimensions and weights not designated minimum or maximum are nominal values and subject to manufacturing tolerances. In this context, weight means mass.

Dead Soft Annealed (DSA) Copper Clad Steel (CCS) Grounding Conductor

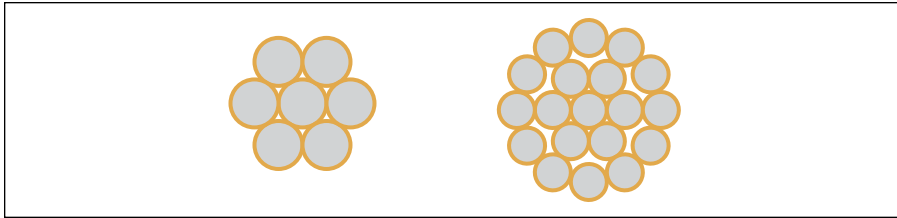

Product Construction:

Complete Conductor:

Dead Soft Annealed (DSA) Copper Clad Steel (CCS) conductors are concentric-lay-stranded. The CCS strands are a 40% conductivity grade previously referred to as Grade 40A. The wire is manufactured using a low carbon steel core, rendering greater flexibility to enable easier handling during installation. The direction of lay for the outer layer is left-hand. The direction of lay of each successive layer is reversed. DSA CCS grounding conductors are manufactured in accordance with ASTM B910, B258 and B228, as applicable.

DSA COPPER CLAD STEEL CONDUCTORS, CONCENTRIC-LAY-STRANDED

SIZE DESIG.	SIZE NO. X WIRE AWG	NO. X DIA. INCHES	CROSS-SECTION SQ. INCHES	O.D. INCHES	APPROX. WEIGHT LBS/1000 FT	MIN. BREAKING STRENGTH LBS	MAX. DC RESISTANCE @ 20°C OHMS/KFT	STANDARD PACKAGES (1)	
								REEL DESIG.	LENGTH FEET
11/32"	7 x #9 AWG	7 x 0.1144	0.07195	0.343	0.259	2510	0.2974	W 46X36	15900
3/8"	7 x #8 AWG	7 x 0.1285	0.09078	0.385	0.327	3170	0.2358	W 46X36	12500
7/16"	7 x #7 AWG	7 x 0.1443	0.1145	0.433	0.413	4000	0.1870	W 46X37	10000
1/2"	7 x #6 AWG	7 x 0.1620	0.1443	0.486	0.520	5040	0.1483	W 46X38	7900
9/16"	7 x #5 AWG	7 x 0.1819	0.1819	0.546	0.656	6300	0.1177	W 46X39	6200
9/16"	19 x #9 AWG	19 x 0.1144	0.1953	0.572	0.707	6820	0.1100	W 46X40	5700
21/32"	19 x #8 AWG	19 x 0.1285	0.2464	0.642	0.892	8610	0.0872	W 46X41	4490
23/32"	19 x #7 AWG	19 x 0.1443	0.3107	0.721	1.125	10850	0.0691	W 46X42	3600
13/16"	19 x #6 AWG	19 x 0.1620	0.3916	0.810	1.418	13680	0.0549	W 46X43	2840
7/8"	19 x #5 AWG	19 x 0.1819	0.4938	0.910	1.787	17250	0.0435	W 46X44	2230

Dimensions and weights not designated minimum or maximum are nominal values and subject to manufacturing tolerances. In this context, weight means mass.

Features and Benefits:

Stranded DSA Copper Clad Steel conductors are used for buried ground grid systems where a more economical alternative to copper conductors is desired.

For utility applications, Copper Clad Steel is used in substation and generation plant ground grids; grounding of metal fences; and in building and structure lightning protection systems.

Copper Clad Steel is tough to cut and unlike copper conductors has virtually no scrap recovery value, thus reducing the potential of theft or vandalism of the grounding wire.

Applications:

DSA Copper Clad Steel stranded conductors are used in place of copper conductors in grounding applications and systems. The size and construction of the Copper Clad Steel conductor is generally selected by matching the approximate diameter equivalence to a copper conductor. Please note that the ampacity rating and the dc and ac resistance of the Copper Clad Steel wire conductor is not equivalent to that of the copper conductor.

For more information, or information on other conductor sizes, designs and/or specific installation requirements not shown in the tables, contact your General Cable sales representative or e-mail infoca@generalcable.com.

Steel Overhead Ground Wire and Steel Guy Wire

Product Construction:

Complete Conductor:

Steel overhead ground wire and steel guy wire are concentric-lay-stranded constructions.

Steel overhead ground wire and steel guy wire are manufactured in accordance with the requirements of CSA specification G12.

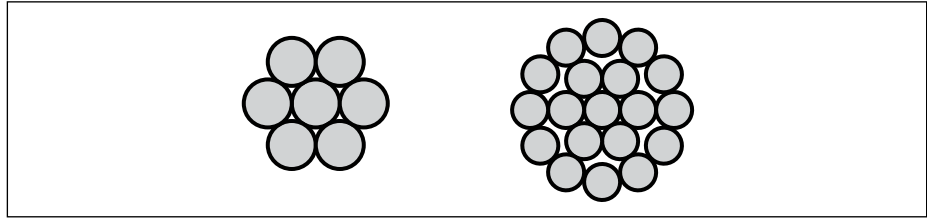

Features and Benefits:

The steel wires are protected from corrosion by galvanizing. The standard Class A zinc coating is adequate for ordinary environments.

Applications:

Steel overhead ground wires are used for in-air applications under tension. Guy wires are used for structure tension applications, shield wires, static wires, overhead ground wires, messengers, span wires, etc. For overhead applications, CSA G12 does not permit splices in any of the steel strand wires.

For more information, or information on other conductor sizes, designs and/or specific installation requirements not shown in the tables, contact your General Cable sales representative or e-mail at info@generalcable.com.

DIMENSIONS – CONCENTRIC LAY STRANDING (SI UNITS)									
STRAND DESIGNATION	NOMINAL STRAND DIAMETER (mm)	NO. OF WIRES	NOMINAL WIRE DIAMETER (mm)	NOMINAL CENTER WIRE DIAMETER (mm)	RATED STRENGTH (kN)				APPROX. WEIGHT (KG/KM)
					GR 800	GR 1100	GR 1300	GR 1500	
5	5.10	7	1.70	--	12.0	16.5	19.5	22.5	130
6	6.30	7	2.10	--	18.0	25.0	30.0	34.5	190
7	7.20	7	2.40	--	24.0	33.0	39.0	45.0	250
8	8.40	7	2.80	--	33.0	45.0	53.0	61.5	340
9	9.00	7	3.00	--	37.5	52.0	61.0	70.5	390
10	10.8	7	3.60	--	54.0	74.5	88.0	102	560
12	12.6	7	4.20	--	74.0	101	120	138	760
14	14.4	19	2.80	3.20	85.5	118	139	161	930
16	16.2	19	3.20	3.40	110	152	180	208	1210
18	18.2	19	3.60	3.80	140	193	228	263	1530
20	20.2	19	4.00	4.20	173	238	281	324	1890
22	22.2	19	4.40	4.60	209	287	340	392	2280
24	24.2	19	4.80	5.00	249	342	404	466	2710
26	26.8	19	5.30	5.60	304	418	493	569	3310

DIMENSIONS – CONCENTRIC LAY STRANDING (US CUSTOMARY UNITS)									
STRAND DESIGNATION	NOMINAL STRAND DIAMETER (INCHES)	NO. OF WIRES	NOMINAL WIRE DIAMETER (INCHES)	NOMINAL CENTER WIRE DIAMETER (INCHES)	RATED STRENGTH (LBS)				APPROX. WEIGHT (LBS/1000 FT)
					GR 110	GR 160	GR 180	GR 220	
3/16	0.195	7	0.065	--	2,400	3,500	4,000	4,800	79
1/4	0.249	7	0.083	--	3,900	5,700	6,400	7,900	129
9/32	0.285	7	0.095	--	5,200	7,500	8,500	10,300	169
5/16	0.327	7	0.109	--	6,800	9,900	11,100	13,600	223
3/8	0.36	7	0.12	--	8,200	12,000	13,500	16,500	270
7/16	0.432	7	0.144	--	11,900	17,300	19,500	23,800	389
1/2	0.495	7	0.165	--	15,600	22,700	25,500	31,200	511
9/16	0.564	7	0.188	--	20,300	29,500	33,200	40,600	664
5/8	0.621	7	0.207	--	24,600	35,800	40,200	49,200	813
9/16	0.569	19	0.113	0.117	18,900	27,500	30,900	37,800	657
5/8	0.634	19	0.125	0.134	23,000	33,600	37,700	46,100	806
11/16	0.688	19	0.136	0.144	27,500	40,000	45,000	55,000	954
3/4	0.762	19	0.150	0.162	33,500	48,700	54,800	67,000	1163
13/16	0.815	19	0.161	0.171	38,700	56,000	63,100	77,100	1338
7/8	0.894	19	0.177	0.186	46,200	67,300	75,700	92,500	1613
15/16	0.94	19	0.186	0.196	51,400	74,700	84,100	102,800	1784
1	1.01	19	0.200	0.208	59,100	85,900	96,700	118,110	2057

Dimensions and weights not designated minimum or maximum are nominal values and subject to manufacturing tolerances. In this context, weight means mass.

NUAL® Brand RW90 High Speed (HS) XLPE, Low-Voltage Power 600 V, CSA Type RW90, Single Conductor, Aluminum



Features:

- Rated 90°C wet and dry locations
- UV/sunlight-resistant, moisture-resistant and flame-retardant insulation in all colors
- Meets cold bend and cold impact tests at -40°C
- Excellent electrical, thermal and physical properties
- Resistant to crush, compression cuts and heat deformation
- High Speed (HS) cable features a specially designed XLPE insulation that allows for fast and easy cable pulls

Compliances:

- **Industry Compliances:**
- CSA C22.2 No. 38 Type RW90, CSA File #LL028117
- OSHA Acceptable
- Canadian Electrical Code CEC

Other Compliances:

- RoHS Compliant

Packaging:

- Material cut to length and shipped on non-returnable wood reels

Product Construction:

Conductor:

- 6 AWG thru 2 AWG Class B compact stranded aluminum alloy (8000 series) per ASTM B800 and ASTM B801
- 1 AWG thru 350 kcmil compact stranded SIW aluminum alloy (8000 series) per ASTM B800, ASTM B801 and ASTM B836
- 400 kcmil thru 1000 kcmil Class B compact stranded aluminum alloy (8000 series) per ASTM B800 and ASTM B801

Insulation:

- Flame-retardant Cross-linked Polyethylene (XLPE)

Print:

- GENERAL CABLE® (PLANT OF MFG) SIZE (AWG OR KCMIL)(MM²) AL ACM NUAL® RW90 XLPE HS (-40°C) 600 V SUN-RES CSA LL28117 YEAR DATE (TIME OF MFG) SEQUENTIAL METER MARK

Options:

- Other sizes and stranding options available upon request
- Available in non-High Speed
- Available in black and full color skin coat
- Available in FeederPlex HS® Type RW90

Applications:

- In accordance with Canadian Electrical Code (CEC), Part 1
- For wiring exposed to the weather
- For use in raceways (except cable trays) in dry, damp or wet locations in accordance with Canadian Electrical Code (CEC)
- For termination and splicing of aluminum conductors, refer to CEC Rule 12-118
- Type RW90 XPLE is certified to be pulled into underground ducts
- Standard RW90 XLPE is not approved for direct burial in the earth

COND. SIZE (AWG or kcmil)	NUMBER OF WIRES	NOM. COND. DIAMETER		MIN. AVERAGE INS. THICKNESS		NOM. CABLE DIAMETER		ALUMINUM CONDUCTOR WEIGHT		NET WEIGHT		AMPACITY (1) 30°C AMBIENT	
		INCHES	mm	INCHES	mm	INCHES	mm	LBS/1000 FT	KG/KM	LBS/1000 FT	KG/KM	@ 75°C	@ 90°C
8 AWG - 1000 kcmil CONDUCTORS													
8	7	0.134	3.40	0.045	1.14	0.224	5.69	16	24	26	39	40	45
6	7	0.169	4.29	0.045	1.14	0.259	6.58	25	37	39	58	50	55 ⁽²⁾
4	7	0.213	5.41	0.045	1.14	0.303	7.70	39	58	56	83	65	75
2	7	0.268	6.81	0.045	1.14	0.358	9.09	62	92	83	124	90	100
1	8	0.298	7.57	0.055	1.40	0.408	10.36	79	118	108	161	100	115
1/0	10	0.337	8.56	0.055	1.40	0.447	11.35	99	147	132	196	120	135
2/0	12	0.374	9.50	0.055	1.40	0.484	12.29	125	186	162	241	135	150
3/0	16	0.421	10.69	0.055	1.40	0.531	13.49	158	235	199	296	155	175
4/0	19	0.470	11.94	0.055	1.40	0.580	14.73	199	296	244	363	180	205
250	23	0.514	13.06	0.065	1.65	0.644	16.36	235	350	292	435	205	230
300	22	0.566	14.38	0.065	1.65	0.696	17.68	282	420	345	513	230	260
350	26	0.607	15.42	0.065	1.65	0.737	18.72	329	490	397	591	250	280
400	37	0.659	16.74	0.065	1.65	0.789	20.04	376	560	443	659	270	305
500	37	0.736	18.69	0.065	1.65	0.866	22.00	471	701	544	810	310	350
600	61	0.813	20.65	0.080	2.03	0.973	24.71	565	841	664	988	340	385
750	61	0.908	23.06	0.080	2.03	1.068	27.13	706	1051	817	1216	385	435
1000	61	1.060	26.92	0.080	2.03	1.220	30.99	941	1400	1071	1594	445	500

Dimensions and weights are nominal; subject to industry tolerances.

(1) Ampacity based on the Canadian Electrical Code (CEC) Part 1 Table 4 for three conductors in raceway. Refer to CEC Rules 4-004 and 4-006.

(2) For 3 wires, 120/240 V and 120/208 V residential services or subservices, the allowable ampacity for #6 AWG shall be 60A. In this case, the 5% adjustment of CEC Rule 8-106(1) cannot be applied. Refer to CEC® Rule 4-004(23) and Table 39.

COLOR CODE CHART

Color Code	Color	Color Code	Color
1	Black	7	Blue
2	White	8	Orange
3	Red	9	Gray
4	Green	A	Purple
5	Yellow	C	Tan
6	Brown	-	-



RW90 XLPE, Low-Voltage Power, 600 V CSA Type RW90, Single Conductor, High Speed, Copper

Product Construction:

Conductor:

- 14 AWG thru 750 kcmil annealed Class B compressed stranded soft drawn plain copper
- 14 AWG thru 10 AWG solid plain copper

Insulation:

- Heat- and moisture-resistant, low temperature Cross-linked Polyethylene (XLPE), Type RW90 (-40°C)
- Color code: 14 AWG, 12 AWG, 10 AWG (solid) - black, white, red, blue, green, yellow, orange, brown; 10 AWG - black, white, red, blue, green; 8 AWG thru 2 AWG - black, white, red, blue, green; 1 AWG and larger - black (other colors available subject to minimum order quantity)

Print:

- GENERAL CABLE® (PLANT OF MFG) 1C SIZE (AWG OR KCMIL)(MM2) HIGH SPEED CU XLPE 600 V RW90 CSA (-40C) YEAR OF MFG SEQUENTIAL METER MARKING
NOTE: For black insulation, add - SR



Options:

- For 1000 volt applications, use RWU90
- PVC jacket (FT1 rating)

Applications:

- In accordance with Canadian Electrical Code (CEC), Part 1
- For wiring exposed to the weather (black color only)
- For use in raceways (except cable trays) in dry, damp or wet locations in accordance with Canadian Electrical Code (CEC)
- Refer to CEC Table 19 for conditions of use

Features and Benefits:

- Rated 90°C wet and dry
- Meets cold bend and cold impact tests at -40°C
- High Speed (HS) cable features a specially designed XLPE insulation that allows for fast and easy cable pulls

Compliances:

Industry Compliances:

- CSA Standard C22.2 No. 38
- CSA Approval File Number 156400

Packaging:

- Available in various standard lengths

COND. SIZE (AWG or kcmil)	COND. STRAND**	NOMINAL CONDUCTOR O.D.		MIN. AVERAGE INS. THICKNESS		NOMINAL CABLE DIAMETER		COPPER WEIGHT		NET WEIGHT		AMPACITY*** 30°C AMBIENT
		INCHES	mm	INCHES	mm	INCHES	mm	LBS/1000 FT	kg/km	LBS/1000 FT	kg/km	
14 AWG - 1000 kcmil CONDUCTORS												
14	1	0.064	1.62	0.030	0.76	0.126	3.20	12	18	17	26	25
14	7/.0240	0.071	1.80	0.030	0.76	0.133	3.38	12	18	18	26	25
12	1	0.080	2.04	0.030	0.76	0.142	3.61	20	29	25	37	30
12	7/.0302	0.089	2.26	0.030	0.76	0.151	3.84	20	29	26	38	30
10	1	0.101	2.57	0.030	0.76	0.163	4.14	31	46	37	56	40
10	7/.0381	0.113	2.87	0.030	0.76	0.175	4.45	32	47	39	58	40
8	7/.0481	0.142	3.61	0.045	1.14	0.236	5.99	50	75	62	93	55
6	7/.0606	0.178	4.52	0.045	1.14	0.272	6.91	78	117	93	138	75
4	7/.0772	0.225	5.72	0.045	1.14	0.319	8.10	129	192	147	218	95
3	7/.0867	0.252	6.40	0.045	1.14	0.346	8.79	163	243	183	272	115
2	7/.0974	0.283	7.19	0.045	1.14	0.377	9.58	200	298	220	327	130
1	19/.0664	0.322	8.18	0.055	1.40	0.436	11.07	258	384	281	417	145
1/0	19/.0745	0.360	9.14	0.055	1.40	0.477	12.12	326	485	359	534	170
2/0	19/.0837	0.410	10.41	0.055	1.40	0.522	13.26	411	612	448	666	195
3/0	19/.0940	0.460	11.68	0.055	1.40	0.572	14.53	518	771	559	832	225
4/0	19/.1055	0.510	12.95	0.055	1.40	0.628	15.95	653	972	699	1041	260
250	37/.0822	0.560	14.22	0.065	1.65	0.696	17.68	772	1149	828	1233	290
300	37/.0900	0.610	15.49	0.065	1.65	0.749	19.02	926	1379	988	1470	320
350	37/.0972	0.660	16.76	0.065	1.65	0.799	20.29	1081	1609	1147	1707	350
400	37/.1040	0.710	18.03	0.065	1.65	0.844	21.44	1235	1838	1305	1943	380
500	37/.1162	0.790	20.07	0.065	1.65	0.927	23.55	1544	2298	1622	2414	430
600	61/.0992	0.870	22.10	0.080	2.03	1.038	26.37	1883	2802	1986	2956	425
750	61/.1109	0.970	24.64	0.080	2.03	1.140	28.96	2316	3447	2430	3617	535
1000	61/.1280	1.120	28.45	0.080	2.03	1.289	32.74	3088	4596	3218	4789	615

Dimensions and weights are nominal; subject to manufacturing and industry tolerances.

* Non-stock item; minimum runs apply. Please consult Customer Service for price and delivery.

** For compact-stranded constructions, the number of wires may be reduced as follows:

19-wire constructions - 18 wires minimum

37-wire constructions - 35 wires minimum

61-wire constructions - 58 wires minimum

*** Based on CEC Part 1, Table 2 for three conductors in raceway (conduit). For underground installations, refer to CEC Rule 4-004 for ampacity rating.

**** For 3 wires, 120/240 V and 120/208 V residential services or subservices, the allowable ampacity for 2/0 AWG shall be 200A. In this case, the 5% adjustment of Rule 8-106(1) cannot be applied.



NUAL® Brand RWU90 High Speed (HS) XLPE, Low-Voltage Power 1000 V, CSA Type RWU90, Single Conductor, Aluminum



Features:

- Rated 90°C wet and dry locations
- UV/sunlight-resistant, moisture-resistant and flame-retardant insulation in all colors
- Meets cold bend and cold impact tests at -40°C
- Excellent electrical, thermal and physical properties
- Resistant to crush, compression cuts and heat deformation
- Rated for direct burial
- High Speed (HS) cable features a specially designed XLPE insulation that allows for fast and easy cable pulls

Compliances:

- Industry Compliances:**
- CSA C22.2 No. 38 Type RWU90, CSA File #LL028117
 - OSHA Acceptable
 - Canadian Electrical Code CEC

Other Compliances:

- RoHS Compliant

Packaging:

- Material cut to length and shipped on non-returnable wood reels

Product Construction:

Conductor:

- 6 AWG thru 2 AWG Class B compact stranded aluminum alloy (8000 series) per ASTM B800 and ASTM B801
- 1 AWG thru 350 kcmil compact stranded SIW aluminum alloy (8000 series) per ASTM B800, ASTM B801 and ASTM B836
- 400 kcmil thru 1000 kcmil Class B compact stranded aluminum alloy (8000 series) per ASTM B800 and ASTM B801

Insulation:

- Flame-retardant Cross-linked Polyethylene (XLPE)

Print:

- GENERAL CABLE® (PLANT OF MFG) SIZE (AWG OR KCMIL)(MM²) AL ACM NUAL® RWU90 XLPE HS (-40°C) 600 V SUN-RES CSA LL28117 YEAR DATE (TIME OF MFG) SEQUENTIAL METER MARK

Options:

- Other sizes and stranding options available upon request
- Available in black and full color skin coat

Applications:

- In accordance with Canadian Electrical Code (CEC), Part 1
- For wiring exposed to the weather
- For use in raceways (except cable trays) in dry, damp or wet locations in accordance with Canadian Electrical Code (CEC)
- For termination and splicing of aluminum conductors, refer to CEC Rule 12-118

COND. SIZE (AWG or kcmil)	NUMBER OF WIRES	NOM. COND. DIAMETER		MIN. AVERAGE INS. THICKNESS		NOM. CABLE DIAMETER		ALUMINUM CONDUCTOR WEIGHT		NET WEIGHT		AMPACITY (1) 30°C AMBIENT	
		INCHES	mm	INCHES	mm	INCHES	mm	LBS/1000 FT	KG/KM	LBS/1000 FT	KG/KM	@ 75°C	@ 90°C

8 AWG - 1000 kcmil CONDUCTORS

8	7	0.134	3.40	0.080	2.03	0.294	7.47	16	24	38	57	40	45
6	7	0.169	4.29	0.080	2.03	0.329	8.36	25	37	51	76	50	55 ⁽²⁾
4	7	0.213	5.41	0.080	2.03	0.373	9.47	39	58	70	104	65	75
2	7	0.268	6.81	0.080	2.03	0.428	10.87	62	92	99	147	90	100
1	8	0.298	7.57	0.095	2.41	0.488	12.40	79	118	129	192	100	115
1/0	10	0.337	8.56	0.095	2.41	0.527	13.39	99	147	155	231	120	135
2/0	12	0.374	9.50	0.095	2.41	0.564	14.33	125	186	186	277	135	150
3/0	16	0.421	10.69	0.095	2.41	0.611	15.52	158	235	226	336	155	175
4/0	19	0.470	11.94	0.095	2.41	0.660	16.76	199	296	274	408	180	205
250	23	0.514	13.06	0.110	2.79	0.734	18.64	235	350	329	490	205	230
300	22	0.566	14.38	0.110	2.79	0.786	19.96	282	420	385	573	230	260
350	26	0.607	15.42	0.110	2.79	0.827	21.01	329	490	439	653	250	280
400	37	0.659	16.74	0.110	2.79	0.879	22.33	376	560	488	726	270	305
500	37	0.736	18.69	0.110	2.79	0.956	24.28	471	701	593	882	310	350
600	61	0.813	20.65	0.125	3.18	1.063	27.00	565	841	719	1070	340	385
750	61	0.908	23.06	0.125	3.18	1.158	29.41	706	1051	876	1304	385	435
1000	61	1.060	26.92	0.125	3.18	1.310	33.27	941	1400	1138	1694	445	500

Dimensions and weights are nominal; subject to industry tolerances.

(1) Ampacity based on the Canadian Electrical Code (CEC) Part 1 Table 4 for three conductors in raceway. Refer to CEC Rules 4-004 and 4-006.

(2) For 3 wires, 120/240 V and 120/208 V residential services or subservices, the allowable ampacity for #6 AWG shall be 60A. In this case, the 5% adjustment of CEC Rule 8-106(1) cannot be applied. Refer to CEC Rule 4-004(23) and Table 39.

COLOR CODE CHART

Color Code	Color	Color Code	Color
1	Black	7	Blue
2	White	8	Orange
3	Red	9	Gray
4	Green	A	Purple
5	Yellow	C	Tan
6	Brown	-	-



RWU90 XLPE, Low-Voltage Power, 1000 V

CSA Type RWU90, Single Conductor, High Speed, Copper

Product Construction:

Conductor:

- 14 AWG thru 750 kcmil annealed Class B compressed stranded soft drawn plain copper

Insulation:

- Heat- and moisture-resistant, low temperature Cross-linked Polyethylene (XLPE), Type RWU90 (-40°C)
- Color code: 14 AWG - black, 12 AWG thru 10 AWG - black, white, red, blue, green; 8 AWG thru 2 AWG - black, green, black with white stripe, black with red stripe, black with blue stripe; 1 AWG and larger - black (other colors available subject to minimum order quantity)

Print:

- GENERAL CABLE® (PLANT OF MFG) 1C SIZE (AWG OR KCMIL)(MM2) HIGH SPEED CU XLPE 1000 V RWU90 CSA (-40°C) YEAR OF MFG SEQUENTIAL METER MARKINGS
NOTE: For black insulation, add SR



Options:

- PVC jacket (FT1 rating)

Applications:

- In accordance with Canadian Electrical Code (CEC), Part 1
- For wiring exposed to the weather (black or black with colored stripes)
- For use in raceways (except cable trays) in dry, damp or wet locations in accordance with Canadian Electrical Code (CEC)
- Approved for direct burial per CEC Rule 12-012
- For service entrance below ground
- Refer to CEC Table 19 for conditions of use

Features:

- Rated 90°C wet and dry
- Meets cold bend and cold impact tests at -40°C
- High Speed (HS) cable features a specially designed XLPE insulation that allows for fast and easy cable pulls

Compliances:

Industry Compliances:

- CSA Standard C22.2 No. 38
- CSA Approval File Number 156400

Packaging:

- Available in various standard lengths

COND. SIZE (AWG or kcmil)	COND. STRAND**	NOMINAL CONDUCTOR O.D.		MIN. AVERAGE INS. THICKNESS		NOMINAL CABLE DIAMETER		COPPER WEIGHT		NET WEIGHT		AMPACITY*** 30°C AMBIENT
		INCHES	mm	INCHES	mm	INCHES	mm	LBS/1000 FT	kg/km	LBS/1000 FT	kg/km	
14 AWG - 1000 kcmil CONDUCTORS												
14	7/.0240	0.071	1.80	0.060	1.52	0.197	5.00	12	18	24	35	25
12	7/.0302	0.089	2.26	0.060	1.52	0.215	5.46	20	29	32	48	30
10	7/.0381	0.113	2.87	0.060	1.52	0.239	6.07	32	47	47	69	40
8	7/.0481	0.142	3.61	0.080	2.03	0.308	7.82	50	75	75	111	55
6	7/.0606	0.178	4.52	0.080	2.03	0.344	8.74	78	117	107	159	75
4	7/.0772	0.225	5.72	0.080	2.03	0.391	9.93	129	192	163	243	95
3	7/.0867	0.252	6.40	0.080	2.03	0.418	10.62	163	243	200	298	115
2	7/.0974	0.283	7.19	0.080	2.03	0.449	11.40	200	298	239	355	130
1	19/.0664	0.322	8.18	0.095	2.41	0.518	13.16	258	384	313	465	145
1/0	19/.0745	0.360	9.14	0.095	2.41	0.56	14.22	326	485	386	574	170
2/0	19/.0837	0.410	10.41	0.095	2.41	0.605	15.37	411	612	477	710	195
3/0	19/.0940	0.460	11.68	0.095	2.41	0.655	16.64	518	771	592	880	225
4/0	19/.1055	0.510	12.95	0.095	2.41	0.711	18.06	653	972	735	1093	260
250	37/.0822	0.560	14.22	0.110	2.79	0.791	20.09	772	1149	873	1299	290
300	37/.0900	0.610	15.49	0.110	2.79	0.830	21.08	926	1379	1043	1552	320
350	37/.0972	0.660	16.76	0.110	2.79	0.894	22.71	1081	1609	1198	1783	350
400	37/.1040	0.710	18.03	0.110	2.79	0.930	23.62	1235	1838	1370	2039	380
500	37/.1162	0.790	20.07	0.110	2.79	1.022	25.96	1544	2298	1681	2502	430
600	61/.0992	0.870	22.10	0.110	2.79	1.133	28.78	1883	2802	2052	3053	425
750	61/.1109	0.970	24.64	0.125	3.18	1.235	31.37	2316	3447	2502	3723	535
1000	61/.1280	1.120	28.45	0.125	3.18	1.370	34.80	3088	4596	3328	4953	615

Dimensions and weights are nominal; subject to manufacturing and industry tolerances.

* Non-stock item; minimum runs apply. Please consult Customer Service for price and delivery.

** For compact-stranded constructions, the number of wires may be reduced as follows:

19-wire constructions - 18 wires minimum

37-wire constructions - 35 wires minimum

61-wire constructions - 58 wires minimum

*** Based on CEC Part 1, Table 2 for three conductors in raceway (conduit). For underground installations, refer to CEC Rule 4-004 for ampacity rating.

**** For 3 wires, 120/240 V and 120/208 V residential services or subservices, the allowable ampacity for 2/0 AWG shall be 200A. In this case, the 5% adjustment of Rule 8-106(1) cannot be applied.

Stock Program

General Cable Products Electric Utility Stock Program

As a service to our customers, General Cable maintains an inventory of factory stock for frequently purchased items of Medium-Voltage Power, Bare Overhead Distribution and Low-Voltage Overhead and Underground Service cables. These products are manufactured to industry standard specifications, and are available for immediate shipment from our manufacturing facilities and Regional Distribution Centers across North America.

Terms and Conditions of Sale for Stock Products

Standards:

- All cable stock products are manufactured and tested in accordance with the latest revision of CSA standards.
- Weights and dimensions shown are nominal and subject to standard industry tolerances.

Pricing Policy:

- Firm prices are available for items confirmed in stock for immediate buy and ship.
- Adjustable prices are available and subject to metals escalation/de-escalation at the time of shipment.
- Backorders or delayed shipments may be subject to price adjustment.
- Stock prices and terms of sale are subject to change without notice.

Packaging/Shipping Method:

- Shipments will be made via common carrier. Special instructions must be stated at the time of order. Flatbed shipments (truckload quantities only) are subject to availability and extra freight charges depending upon geographic destinations.
- Length tolerance +/-5%

Inventory Holds:

- No inventory holds will be accepted.
- Stock shall be subject to prior sale.

For a complete list of available stock products, contact your General Cable sales representative.



Handling Recommendations and Packaging Information

7

Recommended Reel Handling Procedures

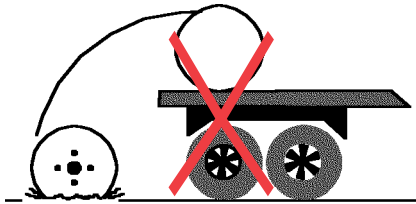

Don't

When off-loading reels from a truck, lower reels carefully using a hydraulic gate, hoist or forklift truck. Never drop reels. If reels must be rolled, roll in opposite direction of the cable wraps to keep cable from loosening on the reel.

When using a hoist, install a mandrel through the reel arbor holes and attach a sling. Use a spreader bar approximately 6 inches longer than the overall reel width placed between the sling ends just above the reel flanges. This will prevent bending the reel flanges and mashing the cable.

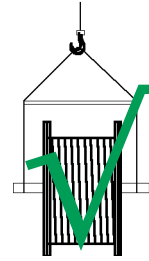

Do

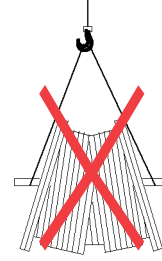

Don't

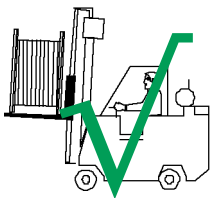

Do

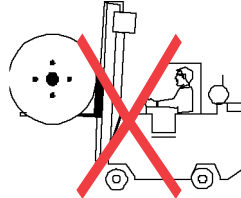

Don't



Don't



Don't

If a forklift is used, approach the reel from the flange side. Position the forks such that the reel is lifted by both reel flanges. Do not allow the lift forks to contact the cable. Care must be taken by the forklift operator not to make sudden turns or stops.

Cable shipped on pallets should be stored indoors if possible. Cable shipped on wooden or metal reels may be stored outdoors. When selecting a storage site, consideration should be given to:

- Traffic patterns during off-loading
- Grade and condition of the soil or pavement
- Protection from vehicle damage during the time in storage
- Environmental conditions such as exposure to heat, corrosive chemicals, etc.

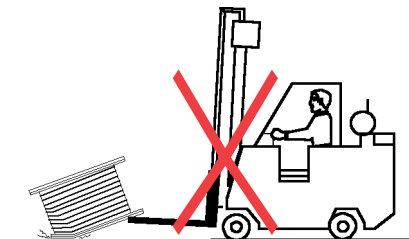

Don't

Cable reels should be stored on hard surfaces resting on the flange's edge (flanges vertical). Align reels flange to flange and, if possible, arrange so that first in is first out. Multiple wooden reels stacked on top of each other ("Pancake" storage) or storing reels flat (flanges horizontal) is not recommended for transmission size bare conductor or medium-voltage cable. The weight of the stack can get extremely heavy, creating an enormous load on the bottom reel. Also, damage to the reel and/or cable will likely occur when the reel is flipped for transit. A concentration of stress on the reel flange may cause it to break and subsequently damage the cable.

Handling Recommendations and Packaging Information

Recommended Reel Handling Procedures

If wooden cable reels must be pancaked or stored in vertical racks, do not lift the reel by the top flange. Spacers placed under the bottom flange and between reels (two 2x4s placed wide side up) create a space to insert the forks and lift the reel without damaging the cable. If nails are used to secure the spacers, make sure the nails do not go through the flange and into the cable. General Cable does not recommend stacking wooden reels with flanges greater than 50" in diameter. Steel reels should never be stored or transported on their sides.

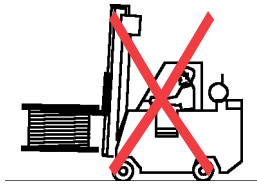

Don't

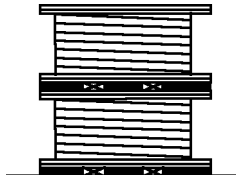

End View of Spacers

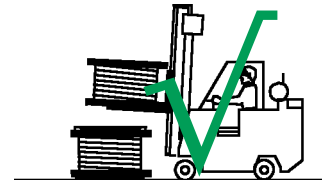

Do

For extended storage of bare or insulated cables (spare cable, etc.), reels should be stored cradled between railroad ties, power poles or crossarms. Size and spacing of the supports should raise the flange above the ground.

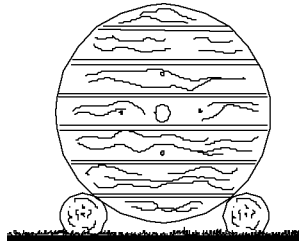

This helps keep the flanges from decaying and prevents the reels from rolling. At temporary storage sites where soil may be soft, preservative-treated plywood sheets may be used to keep reel flanges from sinking into the ground.

When possible, the reel wrap or lagging supplied on the reels should be replaced to help protect the cable from inadvertent damage. Under extreme environmental conditions, other measures may be necessary. To prevent entrance of water, cable ends should be sealed with plastic end caps. Electrical tape does not offer a sufficient seal. When lengths are cut, cable ends should be immediately resealed and secured.

Low temperatures are a cause for concern when installing cable. Cable should not be installed when the ambient temperatures are less than the cold bend temperature rating of the cable product plus 15°C (i.e., the minimum installation temperature = cold bend temperature rating + 15°C). When applicable, the cold bend temperature rating is indicated on the individual product page in this catalog. Polyethylene insulated jacketed low-voltage cables and polyethylene jacketed medium-voltage power cables are suitable for storage and operation at -40°C and should not be handled or installed when the temperature of the cable or the ambient temperature is below -25°C. For other cable designs, cold weather installation may be limited to higher ambient temperatures. For more information about a specific construction, please contact your General Cable sales representative.

If installations are to be carried out where the cable and/or the ambient temperature is below the limit specified above, the cable should first be warmed for a minimum of 48 hours at room temperature (15°C) or higher prior to handling. Cable should be pulled more slowly and trained in place the same day it is removed from storage. Do not impact, drop, kink or bend cable sharply at low temperatures.



Handling Recommendations and Packaging Information

Standard Package and Shipping Information

Shipping Information –

Bare Overhead / Individual Package (Reel or Coil)

Unless otherwise agreed upon at time of quotation

- Standard or special lengths are subject to a **manufacturing length tolerance** per shipping reel of plus or minus **5%** from the specified shipping reel length.
- An amount not exceeding 10% of the total quantity of any order may be shipped in random lengths, with no one length shorter than 50% of the specified shipping reel length.
- When required, bare conductor may be furnished in **matched sets**, with the variation in the measured length within each group being no greater than 150 feet for sets of 6 or less, and 200 feet for sets of 9 and 12. In the case where a random length has been produced, the corresponding matched set group will be cut to within a 10 ft. tolerance. For **matched set reel identification**, on both flanges of the reel, a weatherproof tag is attached that has a Number/Letter identifier marked on it. The number is the numerical sequence from 1, 2, 3, 4, etc for the different sets of matched conductor reels, and the letters A, B, C, etc. identify the matched reels in each set.
- For product **shipped in coils**, 90% of an order quantity shall be furnished in exact lengths as specified in General Cable catalog pages. Exact lengths are specified as having a minus 0% tolerance. Up to 10% of a total order quantity may be supplied in random lengths with no one length shorter than 50% of the specified coil length.
- For bare overhead conductor shipped on wood or steel reels, a reel wrap covering is applied over the conductor. The default reel wrap material consists of a NEMA WC26 Level II (Weather Protector). Individual manufacturing plant preferences may utilize heavier grade level of reel wrap material.

Shipping Information –

Covered and Insulated Cable (Reel or Coil)

Unless otherwise agreed upon at time of quotation

- Standard or special lengths are subject to a manufacturing **length tolerance** per shipping reel of plus or minus **5%** from the specified shipping reel length.
- An amount not exceeding 10% of the total quantity of any order may be shipped in random lengths, with no one length shorter than 80% nor greater than 120% of the specified shipping reel length.
- For product **shipped in coils**, 90% of an order quantity shall be furnished in exact lengths as specified in General Cable catalog pages. Exact lengths are specified as having a minus 0% tolerance. Up to 10% of a total order quantity may be supplied in random lengths, with no one length shorter than 90% of the specified coil length.
- For multiplex service drop cable shipped in coils on pallets, the quantity of coils must be in full pallet load quantities.
- With the exception of cable sold from stock, in support of the Green Initiative and reducing waste, reels are shipped without a reel wrap covering.



Code Word Classifications

Application	Conductor Type	Code Word Family
Bare Overhead Aluminum Conductor	1350 ASC, A1	Flowers (example Tulip)
Bare Overhead Aluminum Conductor/Compact Smooth Body (SB)	1350 ASC/SB, A1F	Reptiles (example Alligator)
Bare Overhead Aluminum Alloy Conductor	6101 T81, AASC, A2	Canadian City Names (example Montreal)
Bare Overhead Aluminum Alloy Conductor	6201 T81, AAAC	US City Names (example Ames)
Bare Overhead Aluminum Conductor Steel-Reinforced	ACSR, A1/S1A	Birds (example Mallard)
Bare Overhead Aluminum Conductor Steel-Reinforced/Compact Smooth Body (SB)	ACSR/SB, A1F/S1A	Fish (example Pike)
Bare Overhead Aluminum Conductor Steel-Reinforced/Trapezoidal (TW)	ACSR/TW	Birds/TW, Rivers or Lakes
Bare Overhead Aluminum Conductor Steel-Reinforced/Self Damping (SD)	ACSR/SD	Birds/SD
Bare Overhead Aluminum Conductor Steel-Supported	ACSS	Birds/ACSS
Bare Overhead Aluminum Conductor Steel-Supported/Trapezoidal (TW)	ACSS/TW	Birds/ACSS/TW
Covered Overhead Aluminum Conductor	1350 ASC, A1	Fruit Trees (example Olive)
Covered Overhead Aluminum Conductor/Compact Smooth Body (SB)	1350 ASC/SB, A1F	Hardwood Trees (example Oakwood)
Covered Overhead Aluminum Conductor Steel-Reinforced	ACSR, A1/S1A	Nut Trees (example Hickory)
Covered Overhead Aluminum Conductor Steel-Reinforced/Compact Smooth Body (SB)	ACSR/SB, A1F/S1A	Exotic Trees (example Mahogany)



Code Word Index

CODE WORD	PAGE	CODE WORD	PAGE	CODE WORD	PAGE	CODE WORD	PAGE		
A									
Adams/AAC/TW.....	70, 71	Bobolink/ACSS/TW.....	112, 113	Cockatoo/SD.....	120, 121	Dove/ACSR/TW.....	92, 93		
Alder.....	129	Bobolink/SD.....	120, 121	Cockscomb/AAC/TW.....	68, 69	Dove/ACSS.....	100, 101		
Alligator.....	64, 65	Brahma.....	84, 85	Columbia/ACSR/TW.....	94, 95	Dove/ACSS/TW.....	110, 111		
Almond.....	128	Brant.....	78, 79	Columbia/ACSS/TW.....	114, 115	Dove/SD.....	118, 119		
Anemone.....	58, 59	Brant/ACSS.....	100, 101	Columbine.....	58, 59	Dragon.....	64, 65		
Anoli.....	64, 65	Breadfruit.....	129	Columbine/AAC/TW.....	68, 69	Drake.....	80, 81		
Anona.....	129	Brockville.....	74, 75	Condor.....	80, 81	Drake/ACCC/TW.....	124, 125		
Apple.....	129	Buckeye.....	128	Condor/ACSR/TW.....	92, 93	Drake/ACSR/TW.....	92, 93		
Apricot.....	129	Bullfinch.....	80, 81	Condor/ACSS.....	102, 103	Drake/ACSS.....	102, 103		
Arbutus.....	58, 59	Bullfinch/ACSS.....	104, 105	Condor/ACSS/TW.....	110, 111	Drake/ACSS/TW.....	110, 111		
Arbutus/AAC/TW.....	68, 69	Bunting.....	82, 83	Condor/SD.....	118, 119	Drake/SD.....	118, 119		
Arlington/ACCC/TW.....	124, 125	Bunting/ACSR/TW.....	92, 93	Coreopsis.....	60, 61	Duck.....	78, 79		
Ash.....	129	Bunting/ACSS.....	104, 105	Coreopsis/AAC/TW.....	68, 69	E			
Aspen.....	128, 129	Bunting/ACSS/TW.....	112, 113	Corkwood.....	129	Eagle.....	78, 79		
Aster.....	58, 59	Bunting/SD.....	120, 121	Cormorant.....	82, 83	Eagle/ACSS.....	100, 101		
Athabaska/ACSR/TW.....	96, 97	Butternut.....	128	Cormorant/ACSS.....	104, 105	Ebony.....	128		
Athabaska/ACSS/TW.....	114, 115	Buttonwood.....	129	Corncrake/ACSS.....	102, 103	Edmonton.....	74, 75		
Auk.....	84, 85	C		Corpus Christi/ACCC/TW.....	124, 125	Egret.....	80, 81		
Avocet/ACSR/TW.....	92, 93	Calgary.....	74, 75	Corypha.....	128	Egret/ACSS.....	102, 103		
Avocet/ACSS.....	104, 105	Calument/ACSR/TW.....	94, 95	Cosmos.....	58, 59	Eider/SD.....	118, 119		
Avocet/ACSS/TW.....	110, 111	Calument/ACSS/TW.....	112, 113	Cosmos/AAC/TW.....	68, 69	El Paso/ACCC/TW.....	124, 125		
Avocet/SD.....	120, 121	Camellia.....	58, 59	Cowbird/SD.....	118, 119	Erne/SD.....	118, 119		
B									
Bamboo.....	128	Camwood.....	129	Cowslip.....	60, 61	Eucalyptus.....	128		
Barwood.....	129	Canary.....	80, 81	Cowslip/AAC/TW.....	68, 69	F			
Bass.....	88, 89	Canary/ACSS.....	102, 103	Crabapple.....	129	Falcon.....	82, 83		
Bay.....	129	Canna.....	58, 59	Crane.....	80, 81	Falcon/ACCC/TW.....	124, 125		
Beachwood.....	129	Canna/AAC/TW.....	68, 69	Crocodile.....	64, 65	Falcon/ACSR/TW.....	94, 95		
Beaumont (Avocet).....	80, 81	Canvasback/ACSS.....	104, 105	Crocus.....	58, 59	Falcon/ACSS.....	106, 107		
Beaumont/ACCC/TW.....	124, 125	Cardinal.....	80, 81	Crow.....	80, 81	Falcon/ACSS/TW.....	112, 113		
Bersfort.....	84, 85	Cardinal/ACCC/TW.....	124, 125	Cuckoo.....	80, 81	Falcon/SD.....	120, 121		
Bersimis.....	84, 85	Cardinal/ACSR/TW.....	92, 93	Cuckoo/ACSS.....	102, 103	Fig.....	129		
Bittern.....	82, 83	Cardinal/ACSS.....	104, 105	Cumberland/ACSR/TW.....	96, 97	Filbert.....	128		
Bittern/ACCC/TW.....	124, 125	Cardinal/ACSS/TW.....	110, 111	Cumberland/ACSS/TW.....	114, 115	Finch.....	80, 81		
Bittern/ACSR/TW.....	94, 95	Cardinal/SD.....	118, 119	Curlew.....	80, 81	Finch/ACSR/TW.....	92, 93		
Bittern/ACSS.....	104, 105	Carillon.....	84, 85	Curlew/ACCC/TW.....	124, 125	Finch/ACSS.....	104, 105		
Bittern/ACSS/TW.....	112, 113	Carnation.....	58, 59	Curlew/ACSR/TW.....	92, 93	Finch/ACSS/TW.....	110, 111		
Bittern/SD.....	120, 121	Carnation/AAC/TW.....	68, 69	Curlew/ACSS.....	104, 105	Finch/SD.....	120, 121		
Bitterroot.....	60, 61	Carp.....	88, 89	Curlew/ACSS/TW.....	110, 111	Flamingo.....	80, 81		
Blackbird/SD.....	118, 119	Catawba/ACSR/TW.....	96, 97	Curlew/SD.....	120, 121	Flamingo/ACSS.....	102, 103		
Bluebell.....	58, 59	Catawba/ACSS/TW.....	114, 115	Cusk.....	88, 89	Flicker.....	78, 79		
Bluebell/AAC/TW.....	68, 69	Cherry.....	129	D				Flicker/ACSR/TW.....	92, 93
Bluebird.....	82, 83	Chestnut.....	128	Daffodil.....	58, 59	Flicker/ACSS.....	100, 101		
Bluebird/ACCC/TW.....	124, 125	Cheyenne/ACSR/TW.....	96, 97	Dahlia.....	58, 59	Flicker/ACSS/TW.....	110, 111		
Bluebird/ACSR/TW.....	94, 95	Cheyenne/ACSS/TW.....	114, 115	Daisy.....	58, 59	Flicker/SD.....	118, 119		
Bluebird/ACSS.....	106, 107	Chickadee.....	78, 79	Dallas/ACCC/TW.....	124, 125	Flounder.....	88, 89		
Bluebird/ACSS/TW.....	112, 113	Chignecto.....	84, 85	Dipper.....	82, 83	Fort Worth/ACCC/TW.....	124, 125		
Bluebird/SD.....	120, 121	Chinquapin.....	129	Dipper/ACSR/TW.....	94, 95	Fredericton.....	74, 75		
Bluebonnet.....	60, 61	Chukar.....	82, 83	Dipper/ACSS.....	106, 107	Frigate/SD.....	120, 121		
Bluejay/ACSR/TW.....	92, 93	Chukar/ACCC/TW.....	124, 125	Dipper/ACSS/TW.....	112, 113	Fuchsia.....	58, 59		
Bluejay/ACSS.....	104, 105	Chukar II/ACCC/TW.....	124, 125	Diver.....	82, 83	G			
Bluejay/ACSS/TW.....	110, 111	Chukar/ACSR/TW.....	94, 95	Diver/ACSS.....	106, 107	Galveston/ACCC/TW.....	124, 125		
Bluejay/SD.....	120, 121	Chukar/ACSS.....	106, 107	Dogwood.....	129	Gannet.....	80, 81		
Bobolink.....	82, 83	Chukar/ACSS/TW.....	112, 113	Dorking.....	84, 85	Gannet/ACSS.....	102, 103		
Bobolink/ACSR/TW.....	94, 95	Chukar/SD.....	120, 121	Dotterel.....	84, 85	Gatineau.....	84, 85		
Bobolink/ACSS.....	106, 107	Chute Des Passes.....	84, 85	Dove.....	78, 79	Gecko.....	64, 65		
D									
Daffodil.....	58, 59	Clayman.....	64, 65	Dove/ACCC/TW.....	124, 125	Genesee/ACSR/TW.....	96, 97		
Dahlia.....	58, 59	Cochin.....	84, 85						

Code Word Index

CODE WORD	PAGE	CODE WORD	PAGE	CODE WORD	PAGE	CODE WORD	PAGE
Genesee/ACSS/TW.....	114, 115	Hudson/ACSS/TW.....	114, 115	Lupine	60, 61	Nectarine	129
Ginko	129	Hummingbird/SD	118, 119	Lupine/AAC/TW	68, 69	Nelson.....	84, 85
Gladiolus	60, 61	Hyacinth	58, 59	M			
Goldenrod.....	58, 59	I				Macaw	80, 81
Goldfinch.....	80, 81	Ibis	78, 79	Macaw/ACSS	102, 103	Nelson/ACSR/TW.....	96, 97
Goldfinch/ACSS	100, 101	Ibis/ACSS.....	100, 101	Macaw/SD	118, 119	Nelson/ACSS/TW.....	114, 115
Goldfinch/SD.....	118, 119	Ibis/SD	118, 119	Mackenzie/ACSR/TW	96, 97	Newt.....	64, 65
Goose	80, 81	Iris.....	58, 59	Mackenzie/ACSS/TW	114, 115	Nuthatch	82, 83
Grackle.....	82, 83	Ironwood	129	Magnolia	58, 59	Nuthatch/ACSS.....	106, 107
Grackle/ACSR/TW	94, 95	Irving/ACCC/TW.....	124, 125	Magnolia/AAC/TW	68, 69	O	
Grackle/ACSS	104, 105	J				Mahogany	129
Grackle/ACSS/TW	112, 113	Jackdaw/SD.....	118, 119	Mallard	80, 81	Oakwood.....	129
Grackle/SD.....	120, 121	James/ACSR/TW	96, 97	Mallard/ACSR/TW.....	92, 93	Oceanside/ACCC/TW	124, 125
Grand Rapid	84, 85	James/ACSS/TW	114, 115	Mallard/ACSS	102, 103	Olive	129
Grapefruit.....	129	Jefferson/AAC/TW	70, 71	Mallard/ACSS/TW.....	110, 111	Orange	129
Grosbeak.....	80, 81	Jessamine.....	60, 61	Mango	129	Orchid.....	58, 59
Grosbeak/ACCC/TW	124, 125	Jessamine/AAC/TW	68, 69	Marigold.....	58, 59	Orchid/AAC/TW	68, 69
Grosbeak/ACSR/TW	92, 93	Joree	82, 83	Marigold/AAC/TW.....	68, 69	Oriole.....	78, 79
Grosbeak/ACSS	102, 103	Joree/ACSS.....	106, 107	Martin.....	82, 83	Oriole/ACCC/TW	124, 125
Grosbeak/ACSS/TW	110, 111	Junco	78, 79	Martin/ACSR/TW	94, 95	Oriole/ACSR/TW	92, 93
Grosbeak/SD.....	118, 119	Junco/ACSS.....	100, 101	Martin/ACSS	106, 107	Oriole/ACSS	100, 101
Grouse.....	84, 85	K				Oriole/ACSS/TW	110, 111
Guinea.....	84, 85	Kestrel/SD.....	118, 119	Martin/SD	120, 121	Ortolan	80, 81
Gull	80, 81	Kettle/ACSR/TW	94, 95	Martin/ACSS	106, 107	Ortolan/ACSR/TW	92, 93
Gum.....	128	Kettle/ACSS/TW	112, 113	Martineau/ACSS/TW	112, 113	Ortolan/ACSS.....	104, 105
H				Maumee/ACSR/TW.....	94, 95	Ortolan/SD	120, 121
Hackberry	128	Killdeer/SD.....	118, 119	Maumee/ACSS/TW.....	112, 113	Osprey.....	78, 79
Haddock	88, 89	Kiwi	80, 81	Mazama/AAC/TW	70, 71	Ostrich.....	78, 79
Hake	88, 89	Kiwi/ACSS.....	106, 107	McKinley/AAC/TW	70, 71	Ostrich/ACSS.....	100, 101
Halifax.....	74, 75	Kiwi/SD.....	120, 121	Meadowsweet.....	58, 59	Oswego/ACSR/TW.....	94, 95
Hawk	78, 79	Komodo	64, 65	Meadowsweet/AAC/TW	68, 69	Oswego/ACSS/TW	112, 113
Hawk/ACCC/TW.....	124, 125	L				Merlin	78, 79
Hawk/ACSR/TW.....	92, 93	Lamprey	88, 89	Merrimack/ACSR/TW	96, 97	Merrimack/ACSS/TW	114, 115
Hawk/ACSS.....	100, 101	Lapwing	82, 83	Merrimack/ACSS/TW	114, 115	Mica	84, 85
Hawk/ACSS/TW.....	110, 111	Lapwing/ACCC/TW	124, 125	Miramichi/ACSR/TW.....	96, 97	Minorca	84, 85
Hawk/SD.....	118, 119	Lapwing/ACSS/TW	106, 107	Miramichi/ACSS/TW.....	114, 115	Mistletoe	58, 59
Hawkweed/AAC/TW	68, 69	Lapwing/ACSR/TW	94, 95	Mistletoe/AAC/TW	68, 69	Mockernut.....	128
Hawthorn	58, 59	Lapwing/ACSS/TW	106, 107	Mockingbird.....	82, 83	Mockingbird.....	82, 83
Hawthorn/AAC/TW	68, 69	Lapwing/ACSS/TW	112, 113	Mockingbird/ACSS	106, 107	Mohawk/ACSR/TW	94, 95
Helens/AAC/TW.....	70, 71	Lapwing/SD	120, 121	Mohawk/ACSS/TW	112, 113	Molles.....	129
Heliotrope	58, 59	Laredo/ACCC/TW.....	124, 125	Moloch	64, 65	Moloch	64, 65
Hen	78, 79	Lark	78, 79	Monitor.....	64, 65	Montreal.....	74, 75
Hen/ACSR/TW	92, 93	Lark/ACSS	100, 101	Mulberry.....	129	Mullet.....	88, 89
Hen/ACSS	100, 101	Larkspur.....	58, 59	Mystic/ACSR/TW	94, 95	Mystic/ACSS/TW	112, 113
Hen/ACSS/TW.....	110, 111	Laurel.....	58, 59	N			
Heron	78, 79	Leghorn.....	84, 85	Narcissus	58, 59	Narcissus.....	58, 59
Heron/ACSS	100, 101	Les Boules.....	84, 85	Narcissus/AAC/TW	68, 69	Nasturtium.....	58, 59
Heron/ACSS/TW.....	110, 111	Liana	128	Nasturtium.....	58, 59	Nasturtium/AAC/TW	68, 69
Hickory.....	128	Lilac	58, 59	P			
Hood/AAC/TW.....	70, 71	Lilac	58, 59	Pansy	58, 59	Parakeet.....	78, 79
Hop.....	129	Linnet	78, 79	Parakeet/ACSR/TW	92, 93	Parakeet/ACSS	100, 101
Hornbeam	129	Linnet/ACCC/TW.....	124, 125	Parakeet/ACSS/TW	110, 111	Parakeet/SD.....	118, 119
Hornbill.....	82, 83	Linnet/ACSS.....	100, 101	Parrot	82, 83	Parrot/ACSS.....	106, 107
Hornbill/ACSS	106, 107	Linnet/SD	118, 119	Partridge	78, 79	Partridge.....	78, 79
Houston/ACCC/TW	124, 125	Logan/AAC/TW	70, 71	Partridge/ACSS.....	100, 101	Partridge/SD.....	118, 119
Huckleberry	129	Longspur/SD	118, 119	Paw Paw	129	Peace River	84, 85
Hudson/ACSR/TW.....	96, 97	Lubbock/ACCC/TW	124, 125	Peach	129	Peach	129



Code Word Index

CODE WORD	PAGE	CODE WORD	PAGE	CODE WORD	PAGE	CODE WORD	PAGE
Pecos/ACSR/TW	96, 97	Quince	129	Sculpin	88, 89	Tody/ACSS	100, 101
Pecos/ACSS/TW	114, 115			Scup	88, 89	Toronto	74, 75
Pee Dee/ACSR/TW	96, 97	R		Seahawk	82, 83	Toucan	78, 79
Pee Dee/ACSS/TW	114, 115	Rail	80, 81	Seahawk/ACSS	106, 107	Toucan/ACSS	100, 101
Pelican	78, 79	Rail/ACSR/TW	92, 93	Seaway	84, 85	Toucan/SD	118, 119
Penguin	78, 79	Rail/ACSS	104, 105	Shad	88, 89	Towhee	80, 81
Peony	58, 59	Rail/ACSS/TW	110, 111	Shasta/AAC/TW	70, 71	Towhee/ACSS	104, 105
Persimmon	129	Rail/SD	118, 119	Shelter Bay	84, 85	Trillium/AAC/TW	68, 69
Petrel	84, 85	Rainier/AAC/TW	70, 71	Silverbelt	129	Trillium	60, 61
Petunia	58, 59	Ratite	82, 83	Skink	64, 65	Trogon/ACSS	100, 101
Pheasant	82, 83	Ratite/ACSS	106, 107	Sloe	129	Truckee/ACSR/TW	96, 97
Pheasant/ACSR/TW	94, 95	Ratite/SD	120, 121	Smew/SD	120, 121	Truckee/ACSS/TW	114, 115
Pheasant/ACSS	106, 107	Raven	78, 79	Snowbird	80, 81	Tuatara	64, 65
Pheasant/ACSS/TW	112, 113	Redbird	80, 81	Snowbird/ACSR/TW	92, 93	Tulip	58, 59
Pheasant/SD	120, 121	Redbird/ACSS	104, 105	Snowbird/ACSS	104, 105	Tulip/AAC/TW	68, 69
Phlox	58, 59	Redbud	128	Snowbird/ACSS/TW	110, 111	Turacos/ACSS	100, 101
Phoebe	78, 79	Redwing	80, 81	Snowbird/SD	120, 121	Turbit/ACSS	102, 103
Phoenix	80, 81	Redwing/ACSS	102, 103	Solah	128	Turkey	78, 79
Phoenix/ACSR/TW	92, 93	Redwood	129	Sole	88, 89	V	
Phoenix/ACSS	102, 103	Regina	74, 75	Sparate	78, 79	Vancouver	74, 75
Phoenix/ACSS/TW	110, 111	Ringdove	82, 83	Sparrow	78, 79	Verbena/AAC/TW	68, 69
Phoenix/SD	118, 119	Ringdove/ACSS	106, 107	Spoonbill	78, 79	Violet	58, 59
Pickerel	88, 89	Ringdove/SD	120, 121	Spoonbill/ACSS	100, 101	W	
Pigeon	78, 79	Rio Grande/ACSR/TW	96, 97	Spoonbill/SD	118, 119	Wabash/ACSR/TW	94, 95
Pignut	128	Rio Grande/ACSS/TW	114, 115	Squab	78, 79	Wabash/ACSS/TW	112, 113
Pigweed	60, 61	Roadrunner	82, 83	Squab/ACSS	100, 101	Waco/ACCC/TW	124, 125
Pike	88, 89	Roadrunner/ACSS	106, 107	Starling	80, 81	Wagtail	82, 83
Piper	78, 79	Robin	78, 79	Starling/ACSS	102, 103	Wagtail/ACSS	106, 107
Pippit/SD	118, 119	Robson/AAC/TW	70, 71	St. Croix/ACSR/TW	96, 97	Walnut	128
Plano/ACCC/TW	124, 125	Rook	80, 81	St. Croix/ACSS/TW	114, 115	Waxwing	78, 79
Platte/ACSR/TW	96, 97	Rook/ACSR/TW	92, 93	Stilt	80, 81	Wheeler/AAC/TW	70, 71
Platte/ACSS/TW	114, 115	Rook/ACSS	100, 101	Stilt/ACSS	102, 103	Whitehorse	74, 75
Plover	82, 83	Rook/ACSS/TW	110, 111	Stork	78, 79	Whitney/AAC/TW	70, 71
Plover/ACSR/TW	94, 95	Rook/SD	118, 119	Stork/ACSS	100, 101	Whooper	80, 81
Plover/ACSS	106, 107	Rose	58, 59	Stork/SD	118, 119	Whooper/ACSS	104, 105
Plover/ACSS/TW	112, 113	Ruddy	80, 81	Sunbird/SD	118, 119	Widgeon	78, 79
Plover/SD	120, 121	Ruddy/ACSS	102, 103	Suwanee/ACSR/TW	94, 95	Widgeon/ACSS	100, 101
Plum	129	S		Suwanee/ACSS/TW	112, 113	Winnipeg	74, 75
Pollock	88, 89	Sagebrush	60, 61	Swan	78, 79	Woodcock	78, 79
Popinjay	82, 83	Salamander	64, 65	Swanate	78, 79	Woodcock/ACSS	100, 101
Popinjay/ACSS	106, 107	San Antonio/ACCC/TW	124, 125	Syringa	58, 59	Woodcock/SD	118, 119
Popinjay/SD	120, 121	Santee/ACSR/TW	96, 97	T		Wood Duck	78, 79
Poppy	58, 59	Santee/ACSS/TW	114, 115	Tailorbird/ACSS	100, 101	Wood Duck/ACSS	100, 101
Potomac/ACSR/TW	96, 97	Sapsucker	78, 79	Teak	128	Y	
Potomac/ACSS/TW	114, 115	Sapsucker/ACSS	100, 101	Teal/ACSS	100, 101	Yukon/ACSR/TW	96, 97
Powder/ACSR/TW	96, 97	Sapsucker/SD	118, 119	Tern	80, 81	Yukon/ACSS/TW	114, 115
Powder/ACSS/TW	114, 115	Scaup	78, 79	Tern/ACSR/TW	92, 93	Z	
Powell/AAC/TW	70, 71	Scaup/ACSS	100, 101	Tern/ACSS	102, 103	Zinnia	58, 59
Ptarmigan/ACSS	100, 101	Schuykill/ACSR/TW	96, 97	Tern/ACSS/TW	110, 111	Zinnia/AAC/TW	68, 69
Puffin	80, 81	Schuykill/ACSS/TW	114, 115	Tern/SD	118, 119		
Puffin/ACSR/TW	92, 93	Scissortail	82, 83	Thames/ACSR/TW	96, 97		
Puffin/ACSS	102, 103	Scissortail/ACSR/TW	94, 95	Thames/ACSS/TW	114, 115		
Puffin/ACSS/TW	110, 111	Scissortail/ACSS	104, 105	Thorn	129		
Puffin/SD	118, 119	Scissortail/ACSS/TW	112, 113	Thrasher	82, 83		
Q		Scissortail/SD	120, 121	Thrasher/ACSS	106, 107		
Quail	78, 79	Scoter	80, 81	Titmouse/SD	118, 119		
Quebec	74, 75	Scoter/ACSS	102, 103	Toad	64, 65		



A Smarter Grid Comes From Smarter Solutions

When you're looking to enhance your smart grid, you'd be wise to partner with a company with more than two centuries of knowledge to share. General Cable is recognized as a leading provider of customer-relevant solutions for the utility industry. Our world-class operations and innovative yet disciplined approach deliver quality products that provide uninterrupted and reliable power and extend the life of the system.

General Cable helped to redefine the grid with pioneering innovations such as...

T-2®

Intelligent design offers robust performance and long life in wind and ice load conditions.

ACSS (formerly SSAC)

Unique ability to operate at higher temperatures to modernize and optimize electrical grids.

HV/EHV Solid Dielectric

Superior cabling system solutions with maximum flexibility and service life.

ACSR/SD

Creative trapezoidal design provides self-damping characteristics to control aeolian vibrations.

With superior products, a highly qualified team of engineers and unparalleled customer support, General Cable is the smart choice for the smart grid.

CONSTRUCTION



Markets:
Commercial, Residential, Institutional

Products:
Building Wire (Al & Cu), Portable
Cord, Industrial Cable

ENERGY



Markets:
Transmission, Distribution, Generation

Products:
Underground Cable, Substation Cable,
Overhead Conductor & Cable

ENTERPRISE & COMMUNICATIONS



Markets:
Commercial/Residential Buildings,
Data Centers, Education, Finance,
Federal/Government, Healthcare,
AV, Manufacturing

Products:
Datacom Cable, Fiber Optic
Cable, Electronics Cable,
Telecommunications Cable

INDUSTRIAL



Markets:
Petrochemical, Food & Beverage,
Automation, Water/Wastewater,
Power Generation, Pulp & Paper

Products:
Portable & Temporary Power Cord,
Instrumentation Cable, Control Cable,
Power Cable, Automation Cable

MILITARY



Markets:
On Land, At Sea, In the Air

Products:
Communications Wire & Cable
(Cu & Fiber), Shore to Ship Power
Cable, Wire Harnesses & Assemblies

General Cable

156 Parkshore Drive
Brampton, Ontario L6T 5M1
Telephone: 800.561.0649
Fax: 800.565.2529
Email: infoca@generalcable.com
www.generalcable.com

MINING



Markets:
Surface, Underground

Products:
Portable & Trailing Mining Cable, Mine
Power Feeder Cable, Industrial Cable

RENEWABLE ENERGY



Markets:
Solar, Hydro, Wind

Products:
Panel Wire, Cu & AL PV Wire, Tower
Wire & Cable, Collection System
Cable, Industrial Cable, Utility Cable

OIL, GAS & PETROCHEMICAL



Markets:
Upstream, Downstream, Midstream

Products:
Offshore Cable, Subsea Cable,
Onshore Cable

TELCO



Markets:
Independent Telephone Operating
Companies (ITOCs), Regional Bell
Operating Companies (RBOCs)

Products:
Air Core Cable, Filled Core Cable,
Wire Products, Central Office Cable

TRANSPORTATION



Markets:
Automotive, Agricultural Equipment,
Rail & Transit, Heavy Duty & Industrial
Trucks, Bus

Products:
On-Vehicle Data Communications,
Control & Power Wire and Cable,
Battery Cable, Primary Wire, Electric
Vehicle (EV) Products, Wire Harnesses
and Assemblies