



Infrastructure
to Support
Cloud Providers
Solution Guide



PANDUIT[®]

infrastructure for a connected world

Infrastructure for a Connected World

Scaling cloud infrastructure globally, consistently, rapidly, and safely with limited environmental impact requires a partner built to deliver to these requirements.

With manufacturing and continuity of supply on a global scale, Panduit has the reach to meet your cloud infrastructure needs where you are with innovative solutions to support your design and deployment objectives; delivering flexible physical infrastructure that is foundational to your cloud services architecture.

A culture of curiosity, a history of innovation

From the first product, a panel conduit that gave us our name, we understood the value of thinking differently.

Here's where it has taken us:

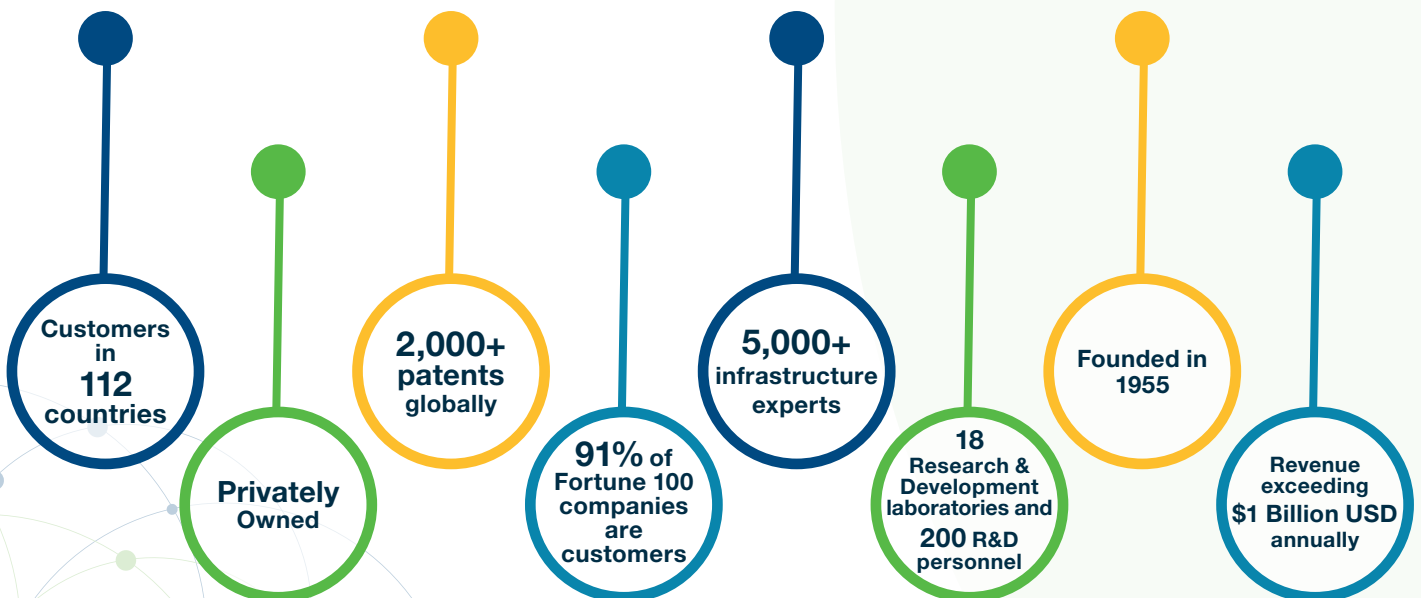



Rapid Deployment

With the rise in demand for distributed cloud architectures, the ability to deploy infrastructure quickly is a critical success factor. Panduit Cloud Infrastructure solutions are designed to support this fast-moving cloud architecture evolution by reducing assembly and installation time.



Global Reach

Panduit operates globally and executes locally. Our global presence, backed by the **Panduit ONE Partner Program**, ensures continuity of supply on a global scale. Our extensive manufacturing capabilities are distributed across nine different locations. In addition to our extensive partner and distributor community, we have ten warehouses to help facilitate and augment the fulfillment operations of our distribution partners.

Innovative Solutions

At Panduit, innovation is in our DNA. We have a rich history of technical advances realized through our engineering expertise, along with our deep understanding of market needs and challenges developed through ongoing customer engagement and collaboration. Panduit infrastructure solutions are standards-based and backed by industry-leading warranties to ensure reliability and dependability.



Environmentally Aligned

Panduit delivers cloud infrastructure solutions for the environmentally aware economy through a focus on carbon footprint reduction, support for the circular economy, reduction in waste, and sustainable product innovation. With carbon neutral certified manufacturing and a LEED-certified Headquarters facility, we are a CO2 reduction leader, maintain an ISO accredited supply chain, and design solutions for RoHS and WEEE compliance.



To learn more about our solutions that support your sustainability initiatives, please view our [Building a Sustainable Network Infrastructure brochure](#).



Safe and Secure for People and Places

Panduit is committed to ensuring a safe and secure operating environment for employees and partners. Our intelligent infrastructure supports site security through electronic access control and environmental monitoring. Our electrical infrastructure solutions, which are unique in the cloud applications space, provide grounding and bonding to protect against electrical accidents. In addition, absence of voltage technologies support personal safety while boosting employee confidence and productivity.



World Class Global Manufacturing and Distribution Ecosystem

Panduit's global support structure for manufacturing, warehousing, sales, technical, and customer service enables real-time responses within each region.

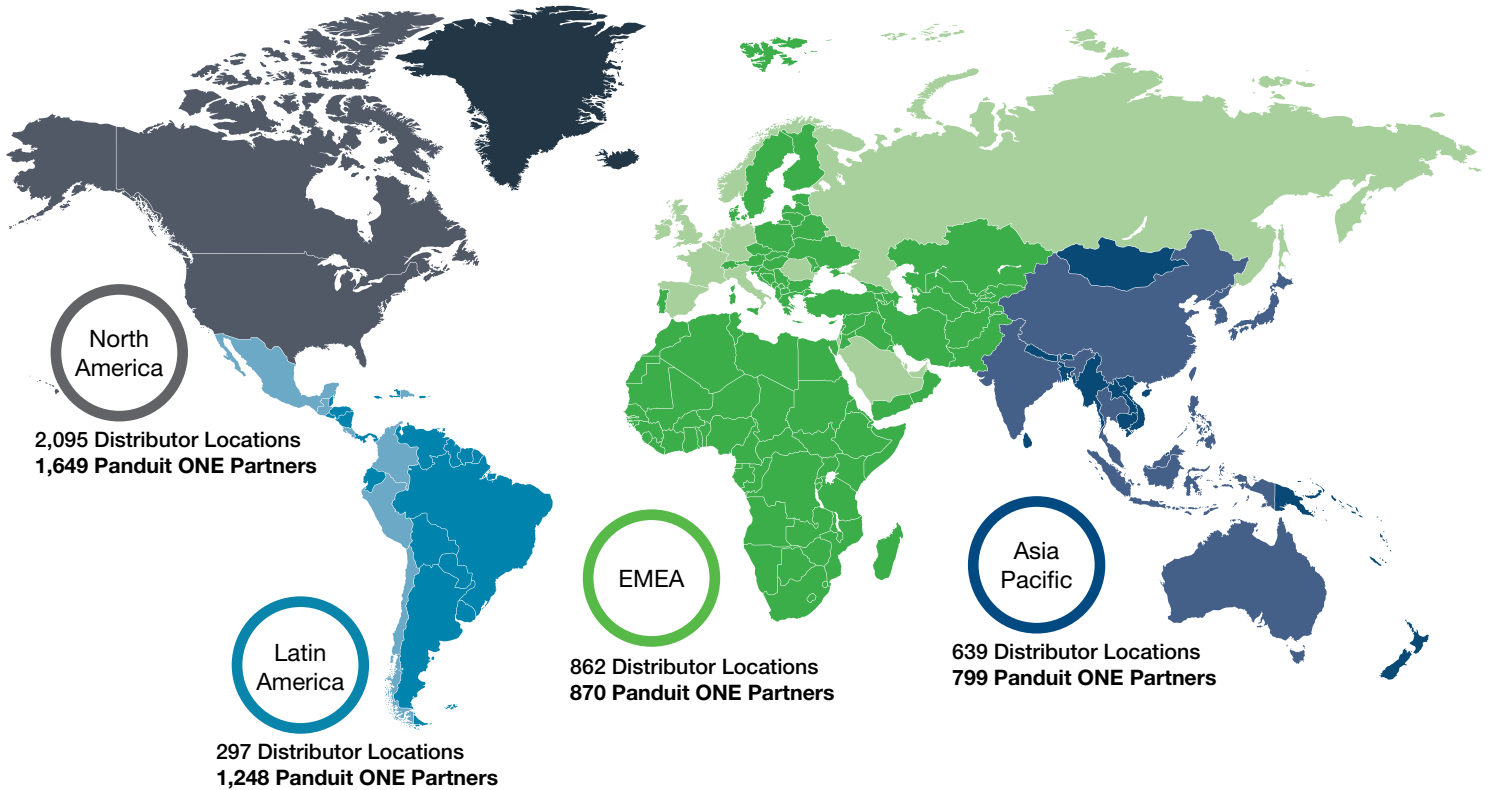

A World of Connections

When it's your vision to connect technology, systems, and people on a global scale, you don't go it alone. That's why we built a support team that is committed to earning your trust and providing a superior customer experience the world over, and a partner ecosystem that spans the project lifecycle, from planning and design to delivery, deployment, maintenance, and operation.

Partner Smarter

Our global network of distributors provides local inventory, product support, and logistics services so our customers can expect to receive exactly what they need when they need it.



Our Panduit One partners include highly skilled installers, contractors, and system integrators who are trained and certified to design, develop, and deploy high-performance electrical and network infrastructures.

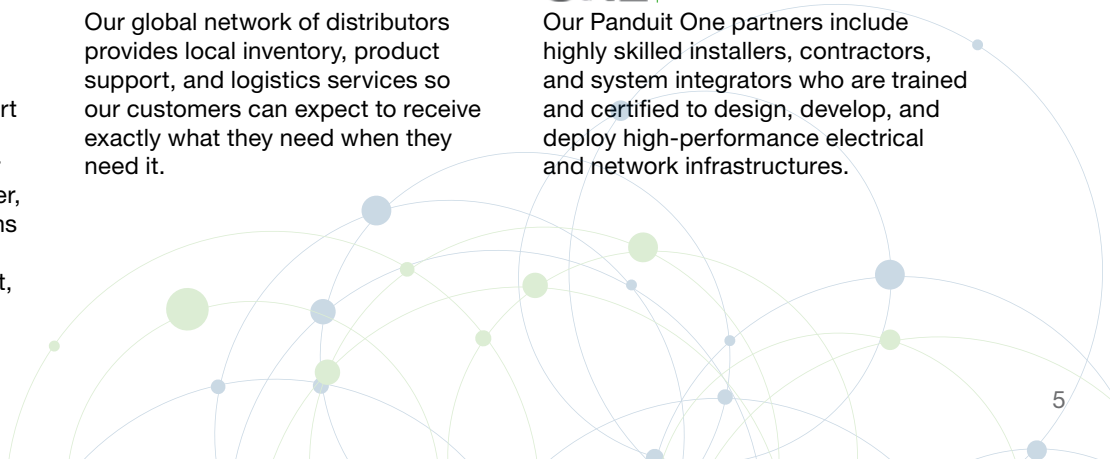

Innovative Solutions to Scale Your Cloud Infrastructure Requirements

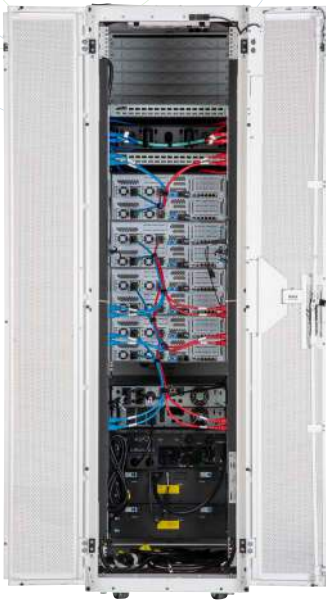

Cabinets and Pathway Solutions



FlexFusion™ Cabinets — [Page 8](#)



FiberRunner®
Pathway Solutions — [Page 21](#)

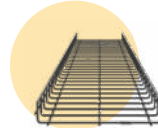

Wire Basket Cable Tray
Routing System — [Page 23](#)

Rack Systems and Cable Management



4-Post Cable Management
Rack System — [Page 15](#)

Power Distribution



SmartZone™ G5
Intelligent PDU — [Page 17](#)

Industrial Electrical Infrastructure Solutions



VeriSafe™ Absence of Voltage
Tester — [Page 36](#)



Grounding and Bonding —
[Page 40](#)



Cable Cleats — [Page 37](#)

Next Generation DCIM Software



SmartZone™ Cloud
Software — [Page 20](#)

Fiber Connectivity

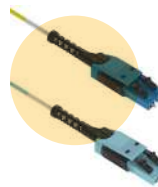

Uniboot Patch Cords —
[Page 30](#)

High Count Fiber Assemblies



Fiber Trunk Assemblies —
[Page 29](#)

Fiber Enclosures



FlexCore™ Optical Distribution
Frame — [Page 33](#)

White Space Solutions

Reduce time from book to bill with a single source provider of all layer 1 infrastructure solutions needs in the white space. Cabinets, hot and cold aisle containment, racks and cable management, power distribution, pathway solutions, and fiber cable connectivity protect your critical connections.

Cabinets

Accelerate deployment with a next-generation cabinet with custom configurations to meet your network needs.

Pages 8-10

Containment

Reduce cooling energy consumption by as much as 40% and optimize the separation of hot and cold air enabling higher per cabinet density.

Page 11

Racks and Cable Management

Ensure network availability, and performance for telecommunication rooms and data centers through strong, capable, and versatile racks and cable management.

Pages 12-16

Power Distribution and Management

Monitor data center power by continuously scanning for electrical circuit overloads and environmental conditions that place critical IT equipment at risk.

Pages 17-19

Pathway Solutions

Segregate, route, and protect fiber optic and high-performance copper cabling from distribution areas to equipment cabinets or racks.

Page 21-26

Fiber Connectivity

Comprehensive fiber optic systems that support advanced bandwidth and mission-critical physical infrastructures that deliver high performance, reliability, and scalability.

Page 27-30



Next-generation cabinet with custom configurations to meet your network needs.

FlexFusion™ Cabinets are ideal for network and server equipment and provide maximum flexibility and the capacity to manage high cable density in data center, enterprise or colocation deployment. Available in a full range of sizes and broad selection of options that can be factory installed for a turn-key solution to meet your application.

- Easy to adjust E-rails, PDU installation, and accessories to reduce installation time
- Solid construction with best-in-class load rating for secure installation
- Choice of key lock, 3-digit combo or HID electronic, and/or keypad lock
- Choice of tool-less fingers, vertical cable manger or front-to-back cable manager
- Turnkey deployment with pre-configured PDU, access control, and environmental monitoring
- Universal design for server or network applications
- 80% perforated doors for increasing power density in newer deployments
- Configuration platform to create cabinet to meet your specification and requirements

Cabinet Dimensions

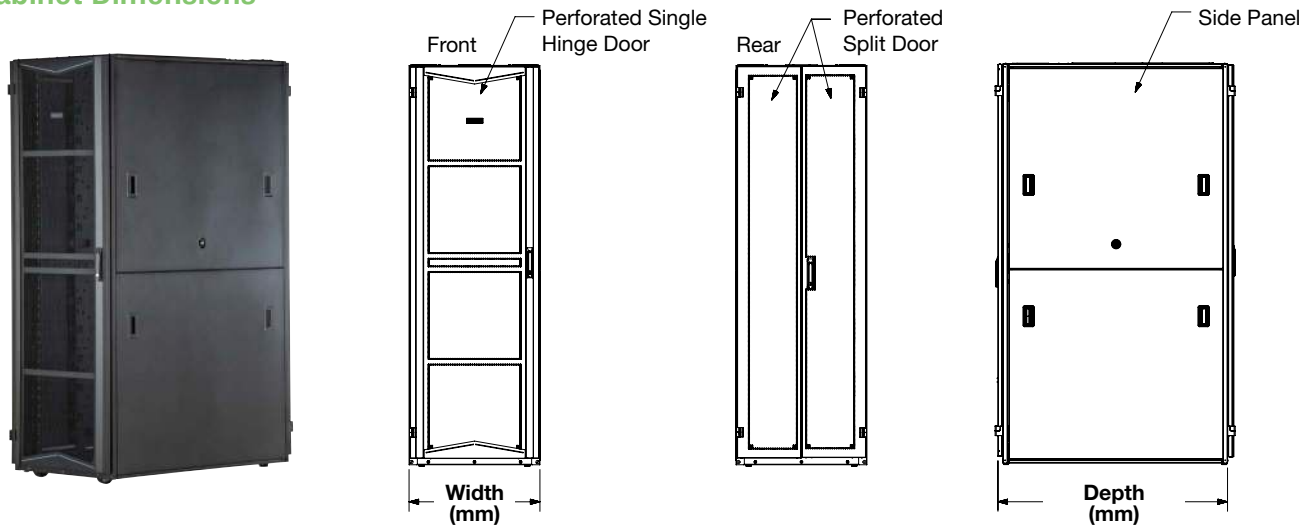

Ordering information

Part Numbers	Width (mm)	Rack Units (RU)	Depth (mm)	Side Panels	Color	Top Cab Type	Doors	PDU Mounting Bracket	Cable Management Fingers	Vertical Cable Management Bracket	Casters	PDU Included																	
XG64519BS0014	600	45	1070	None	Black	Brush Seal	Included	Left Side	One Short Set	No	Yes	No																	
XG64519BS00A1			None																										
XG64529BS0014			Included																										
XG64529BS00A1			None																										
XG64819BS0014		48	1070				Included																						
XG64819BS00A1			None																										
XG64829BS0014			1200				Included																						
XG64829BS00A1			None																										
XG65229BS00W0		52	1200				None						Black	Brush Seal	Included	Both Sides	One Long Set	Yes	No	No									
XG65222BS00W0							Included																						
XG84819BS0002							48								1070						None	Black	Brush Seal	Included	Left Side	One Long Set	No	Yes	No
XG84819BS00WB															None														
XG84829BS0002	Included																												
XG84829BS00WB	None																												
XG85229BS00N8	52	1200	None	Black	Brush Seal	Included	Both Sides	One Long Set	Yes	No	No																		
XG85222BS00N8												Included																	

For more information about the FlexFusion™ Cabinet offering visit www.panduit.com/flexfusion. To configure FlexFusion™ Cabinets with additional design options, visit www.panduit.com/configure-cabinet.

FlexFusion™ XGL



FlexFusion™ XGL Cabinets are the preferred choice for applications that require maximum flexibility in data center, enterprise or colocation deployment. Select from 16 models that are equipped with the essential options that provides a simple cost-effective cabinet solution.

- Front single hinged door and split-hinged rear door with 80% open perforation
- Horizontally split side panels
- Adjustable front and rear cage nut equipment rails
- Includes 1 set of PDU mounting bracket, casters, ganging brackets and heavy-duty leveling legs
- Fully integral bonded without use of grounding wire-equipment rails, doors, side panels and top cap
- Static load rating – 3500 lbs. and rolling load rating – 2500 lbs.

Ordering information

Part Number	Width (mm)	Cabinet Height (RU)	Depth (mm)	Color
XGL64212B	600	42 RU	1070	Black
XGL64222B			1200	
XGL64812B		48 RU	1070	
XGL64822B			1200	
XGL84212B	800	42 RU	1070	
XGL84222B			1200	
XGL84812B		48 RU	1070	
XGL84822B			1200	
XGL64212W	600	42 RU	1070	White
XGL64222W			1200	
XGL64812W		48 RU	1070	
XGL64822W			1200	
XGL84212W	800	42 RU	1070	
XGL84222W			1200	
XGL84812W		48 RU	1070	
XGL84822W			1200	

For a full listing of FlexFusion XGL Accessories, please visit the [FlexFusion XGL Spec Sheet](#).

FlexFusion™ Accessories

Cable Management Fingers



Part Number	RU	Length (In.)	Color
XG-FML45B	42 – 45	6	Black
XG-FML45W			White
XG-FML48B	48		Black
XG-FML48W			White
XG-FMS45B	42 – 45	4	Black
XG-FMS45W			White

PDU Mounting Brackets



Part Number	Description	Color
XG-PBRB	FlexFusion™ PDU Mounting Bracket	Black
XG-PBRW		White

Vertical Cable Management Panels



Part Number	RU	Color
XG-VCM42B	42	Black
XG-VCM42W		White
XG-VCM45B	45	Black
XG-VCM45W		White
XG-VCM48B	48	Black
XG-VCM48W		White

Thermal Sealing Accessories



Part Number	Description	Color
TLBP1S-V	1 RU tool-less blanking panel, square hole 19" (483mm) width for 3/8" cage nut holes (may be used with or without cage nuts installed).	Black
TLBP2S-V	2 RU tool-less blanking panel, square hole 19" (483mm) width for 3/8" cage nut holes (may be used with or without cage nuts installed).	
FLBSIM-51	Full-length blanking shade blanks out 1 – 51 consecutive rack units on standard 19" (482.6mm) wide vertical mounting rails.	
BFS100X2000	Adhesive-backed foam strips, 1/16" (1.6mm) closed-cell vinyl foam, perforated to create multiples of 1.00 inch x 20.00 inch strips.	

Strain Relief Bars



Part Number	Description	Rack Units
SRBS19BL-XY	Strain relief bar, straight; to support and manage cable.	Black
SRB19BLY	The strain relief bar is a metal bar that extends 2.8 inches from the rear of a rack and provides support to cables exiting the back of a patch panel. Optional quick release brackets enable strain relief bars to be removed and re-installed without the use of tools.	
SRB19D5BL	The strain relief bar is a metal bar that extends 4.5 inches from the rear of a rack and provides support to cables exiting the back of a patch panel. Inward mounting tabs provides a wider opening. Optional quick release brackets enable strain relief bars to be removed and re-installed without the use of tools.	
SRB19D7BL	The strain relief bar is a metal bar that extends 7.6 inches from the rear of a rack. An added cross bar provides support to heavier cables exiting the back of a patch panel. Inward mounting tabs provide a wider opening. Optional quick release brackets enable strain relief bars to be removed and re-installed without the use of tools.	
SRBWYC	Strain relief bar with integrated adjustable clips; to support and manage up to 24 cables.	

NetContain™ Universal Aisle Containment Solutions

The Net-Contain™ Universal Aisle Containment System allows users to reclaim underutilized cooling capacity, reduce energy expense, and reduce OpEx by retrofitting their existing data center with a versatile containment system. The system includes an independent support structure, sliding doors, vertical blanking panels, and roof structure. This flexible offering can be configured in Hot Aisle and Cold Aisle containment and allows the addition of cabinets of varying sizes and design as needed, reducing deployment time and capital investment.

Reclaim Cooling Capacity:

Retrofitting the Net-Contain™ Universal Aisle Containment System into your existing data center allows you to optimize the separation of hot and cold air enabling higher per cabinet density, reclaiming 10% of existing cooling capacity.



Day 1 — Containment built without any cabinets.

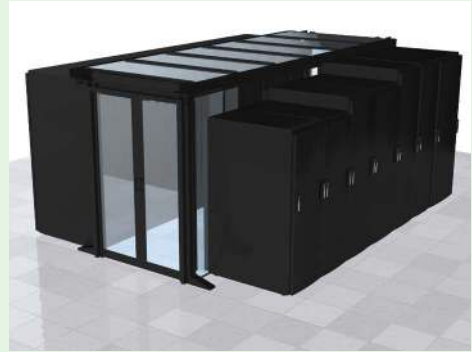

Day 2 — Add cabinets, as your needs dictate enables fast implementation.

Reduce Operational Expense:

Containment reduces cooling energy consumption by as much as 40%.



Expansion

Reduce CapEX:

The Net-Contain™ Universal Aisle Containment System provides you with the flexibility to build a containment system and then add cabinets of varying sizes and design as your needs dictate, reducing the time and capital investment.

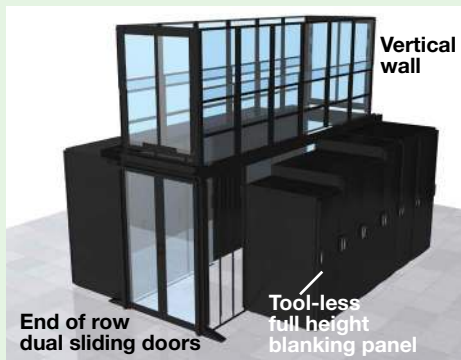

Vertical wall containment typically used for Passive Hot Aisle Containment or Ceiling Discharge Cold Aisle Containment.

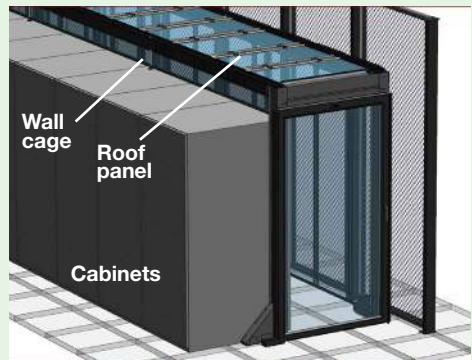

Last row compatible

Let us customize to your containment configuration, contact your Panduit Sales Representative.

Racks and Cable Management

Designed for modern network equipment, Panduit open frame racks provide strength, capacity and versatility. Combined with accessories, such as shelves, PDU brackets and cable managers, Panduit's open frame racks help ensure network availability and performance for Telecommunication Rooms and Data Centers of today.

PatchRunner™ 2 Vertical Cable Management System

- A "push-to-close" door design allows for easy operation
- The doors ship with managers which simplifies the ordering process with less packaging waste
- There are no brackets to install, providing faster installation while reducing labor costs
- Managers and doors are available in black and white
- Individual fingers align with rack spaces to simplify cable routing changes
- The integral bend radius control ensures network performance and system reliability
- An optional snap on vertical retainer can be placed on the fingers to help retain cables in channel for improved cable management and appearance
- An optional slack management spool helps organize and manage patch cord slack allowing for standardization of patch cord lengths



PR2VD08

Part Number	Height In. (mm)	Width In. (mm)	Depth In. (mm)	No. of Rack Units	Single or Dual Sided	No. of Doors Included	Color
PR2VD06	84.0 (2130)	6.0 (152)	20.6 (523)	45	Dual	2	Black
PR2VD08		8.0 (203)					
PR2VD10		10.0 (254)					
PR2VD12		12.0 (305)					
PR2VFD06		6.0 (152)	12.0 (304.8)		Single	1	
PR2VFD08		8.0 (203)					
PR2VSD06		6.0 (152)	20.6 (523)		Dual		
PR2VSD08		8.0 (203)					

Cable Management Accessories



PR2VWF

Part Number	Description	Color
PR2VRGSK12	Rear Gate System Kit for use with 12-inch wide single-sided PatchRunner™ 2 Vertical Cable Managers, kit of 4 gates.	Black
PR2VWF	Waterfall Trough creates a cable pathway above 2-Post or 4-Post Rack systems and PatchRunner™ 2 Vertical Cable Managers.	

PatchRunner™ 2 Enhanced Vertical Cable Manager with Vertical Patching



PE2VD12

Part Number	Height In. (mm)	Width In. (mm)	Depth In. (mm)	No. of Rack Units	Single or Dual Sided	No. of Doors Included	Color
PE2VD06	84.0 (2130)	6.0 (152)	26.8 (681)	45	Dual	2	Black
PE2VD08		8.0 (203)					
PE2VD12		12.0 (305)					
PE2VFD06		6.0 (152)	16.3 (415)		Single	1	

PatchRunner™ 2 Horizontal Cable Management System



PR2HF2

Part Number	Height In. (mm)	Width In. (mm)	Depth In. (mm)	No. of Rack Units	Single or Dual Sided	No. of Doors Included	Color
PR2HF2	3.6 (90)	19 (484)	7.9 (202)	2	Single	1	Black
PR2HF3	5.41 (135)			3			
PR2HF4	7.1 (179)			4			

NetRunner™ Vertical Cable Management

- Integral cable retainers on the end of each finger provide easy access to route cables between fingers
- Bend radius fingers align with rack spaces to support cables as they transition to the vertical pathway
- Dual hinged covers can be opened 110° to the left or right to provide complete access to the cables inside the vertical pathway
- Vertical managers include hinged covers, mounting brackets and #12–24 screws

NetRunner™ Vertical Cable Manager



WMPV45E

Part Number	Height In. (mm)	Width In. (mm)	Depth In. (mm)	No. of Rack Units	Single or Dual Sided	Color
WMPV45E	83.0 (2108)	4.9 (125)	12.0 (306)	45	Dual	Black
WMPVF45E			6.5 (165)		Single	
WMPVHC45E		6.7 (170)	14.1 (357)		Dual	
WMPV22E	41.5 (1054)	4.9 (125)	12.0 (306)	22	Dual	
WMPVHCF45E	83.0 (2108)	6.7 (170)	7.6 (192)	45	Single	

IN-Cabinet Vertical Cable Managers

- For managing cable within cabinets 27 inches or wider
- Attach to equipment mounting rails
- Two mounting bracket options to facilitate mounting to various cabinet configurations
- Snap-on covers included



CWMPV3340

Part Number	Height In. (mm)	Width In. (mm)	Depth In. (mm)	No. of Rack Units	Orientation	Single or Dual Sided	Color
CWMPV3340	70.0 (1778)	4.7 (119)	3.3 (83)	40	Front Mount	Single	Black
CWMPV3440	71.9 (1825)	3.5 (88)	4.3 (109)		Side Mount		

Open-Access™ Horizontal Cable Managers

- D-ring managers provide an open and efficient way to manage cable
- Patented D-ring design provides flexibility for easy moves, adds, and changes
- Pass-through holes allow front to rear cabling
- Mount to 19" EIA racks and cabinets
- Hardware included
- Ideal when positioning managers above and below a 1 RU patch panel or switch for better port access



CMPHF1

Part Number	Height In. (mm)	Width In. (mm)	Depth In. (mm)	No. of Rack Units	Single or Dual Sided	Color
CMPHF1	1.7 (44)	19.0 (483)	8.6 (218)	1	Single	Black
CMPHF2	3.5 (88)			2		

PatchLink™ Horizontal Cable Managers

- Lightweight plastic construction provides durability and easy installation
- Patented dual hinged cover allows cable access without removing cover
- Rounded edges on fingers protect cables from snags and damage to cable
- Flexible fingers allows easy installation and removal of cables
- Pass-through holes allow front to rear cabling
- Covers and #12–24 mounting screws included
- Recommended for use with NetRunner™ WMPVHC45E and WMPVHCF45E Vertical Managers



WMPF1E

Part Number	Height In. (mm)	Width In. (mm)	Depth In. (mm)	No. of Rack Units	Single or Dual Sided	Color
WMP1E	3.5 (89)	19.0 (483)	8.9 (226)	2	Dual	Black
WMPF1E			3.7 (94)		Single	
WMPH2E			8.9 (226)		Dual	
WMPFSE	1.7 (44)		2.7 (69)	1	Single	
WMPSE			8.9 (226)		Dual	
WMPHF2E	3.5 (89)		3.7 (94)	2	Single	
WMPHFSE	1.7 (44)		2.7 (69)	1		
WMPFSE			7.9 (200)		Dual	

NetManager™ High Capacity Horizontal Cable Managers

- Innovative inset fingers slope inward toward back of managers offering unobstructed access to network cabling for easier moves, adds, and changes
- Rear cable management finger spacing utilizes open D-rings for greater accessibility
- Can be used to create large capacity horizontal pathways for routing cable
- Patented front and rear dual hinged cover allows cable access without removing cover
- Pass-through holes allow for front to rear cabling
- Built in cable retainers hold cable in place for easy moves, adds, and changes
- Covers and #12–24 mounting screws included
- Recommended for use with NetRunner™ WMPVHC45E Vertical Manager or PatchRunner™ 2 Vertical Managers



NMF1



NMF2WH

Part Number	Height In. (mm)	Width In. (mm)	Depth In. (mm)	No. of Rack Units	Single or Dual Sided	Color
NMF1	1.7 (44)	19.0 (482)	6.2 (157)	1	Single	Black
NMF2	3.5 (88)			2		
NM1	1.7 (44)		13.1 (332)	1	Dual	
NM2	3.5 (88)			2		
NMF1WH	1.7 (44)		6.2 (157)	1	Single	White
NMF2WH	3.5 (88)			2		

4-Post Cable Management Rack System

- Independent adjustable front and rear mounting rails can be adjusted while the rack is secured to the floor
- Printed rack space identification on all equipment rails allows for quick location of rack spaces (shipped numbers up per TIA606 specifications; can be set to number down by flipping the rails)
- Multiple mounting holes in top flanges for securing overhead pathways
- Weld nut construction eliminates the need for a second wrench increasing speed and ease of assembly
- Vertical cable managers mount directly to the 4-Post Rack at any of the four corners
- Paint piercing washers included to electrically bond rack for simplified grounding



R4PCN

Part Number	Height In. (mm)	Width In. (mm)	Depth In. (mm)	No. of Rack Units	Equipment Rails	Load Capacity Lbs.	Color		
R4P	84.0 (2134)	23.3 (591)	30.0 (762)	45	#12-24 Threaded	2500	Black		
R4PCN			23.0 (584)		Cage Nut				
R4P23CN									
R4P36								36.0 (914)	#12-24 Threaded
R4P36CN								42.0 (1054)	Cage Nut
R4P42CN									

Adjustable Depth 4-Post Racks

- Supports equipment mounting depths from 23 inches to 42 inches in 0.5 inch increments
- Constructed from heavy-duty steel which provides a sturdy and durable platform for equipment
- Compatible with accessories including: power distribution, unit brackets, vertical tie-off panels, and shelving
- Includes grounding and bonding features that prevent damage from electrical surges and ensure equipment operates reliably



AR4P

Part Number	Height In. (mm)	Width In. (mm)	Depth In. (mm)	No. of Rack Units	Equipment Rails	Color
AR4P	84.13 (2136.9)	20.31 (515.9)	23.00 to 42.00 (584.2 to 1066.8)	45	#12-24 Threaded	Black
AR4P96	96.13 (2441.7)			52		
AR4PCN	84.13 (2136.9)			45	Cage Nut	
AR4PCN96	96.13 (2441.7)			52		

To learn more about our Adjustable Depth 4-Post Racks offering, please visit www.panduit.com/4-post-rack.

2-Post Cable Management Rack System

- Printed rack space identification on all equipment rails allows for quick location of rack spaces; numbers up per TIA606 specifications
- Double-sided #12–24 EIA universal mounting hole spacing
- 24 #12–24 mounting screws included
- When mounting NetRunner™ Managers to channel rack R2P6S, utilize side mount kit WMPVSMK
- Multiple mounting hole locations in each base angle
- Can be used with all cable management and patch panel products in addition to any industry standard 19" components
- Paint piercing washers included to electrically bond rack for simplified grounding; for the complete grounding solution, use StructuredGround™ Kits for racks



R2P

Part Number	Height In. (mm)	Width In. (mm)	Depth In. (mm)	No. of Rack Units	Equipment Rails	Load Capacity Lbs.	Color
R2P	84.0 (2134)	20.3 (516)	3.0 (76)	45	#12–24 Threaded	1000	Black
R2P6S			6.0 (152)			1500	

To learn more about our 2-Post Cable Management Rack System offering, please visit www.panduit.com/2-post-rack.

Rack Mount Shelves

- Mounting hardware included
- Vented shelves provide better heat distribution for active equipment



RSHLF

Part Number	Description	Height In. (mm)	Width In. (mm)	Depth In. (mm)	No. of Rack Units	Material	Load Rating Lbs.	Color
SRM19FM1	2-Post Rack Mount Shelf.	1.7 (44)	19.0 (483)	15.2 (385)	1	Steel	30	Black
RSHLF	4-Post Rack Mount Shelf.			30.0 (762)			275	

Rack Filler Panels

- Direct airflow in cabinet applications
- Mount to standard EIA 19" racks or cabinets
- Reserve rack unit space for future use



DPFP1

Part Number	Height In. (mm)	Width In. (mm)	No. of Rack Units	Color
DPFP1	1.7 (44)	19.0 (483)	1	Black
DPFP2	3.5 (88)		2	

Brackets and Blanking Panels



PEB1

Part Number	Description	No. of Rack Units	Color
Panel Extender Brackets			
PEB1	Set of two brackets, allows 19" rack mountable accessories to mount to 23" wide rack.	1	Black
PEB2		2	



CVPDUB

Part Number	Description	Color
4-Post PDU Bracket		
CVPDUB	PDU bracket kit vertically mounts power distribution units (PDUs) to the back of 4-Post Racks	Black
2-Post PDU Bracket		
R2PPDUB	Mounts power distribution units (PDUs) to the back of 2-Post Racks.	Black
Blanking Panel		
BR1B	Brush seal blanking panel with front to back cable pass-through 1 RU.	Black

SmartZone™ G5 Intelligent PDUs

The SmartZone™ G5 iPDUs monitor the data center power and the environment by continuously scanning for electrical circuit overloads and physical environmental conditions that place critical IT equipment at risk. By monitoring physical access points, the PDUs increase cabinet security to protect your systems and data. With some of the highest outlet densities and the smallest form factors available in the market, your cabinets will be functioning at their most resourceful state.

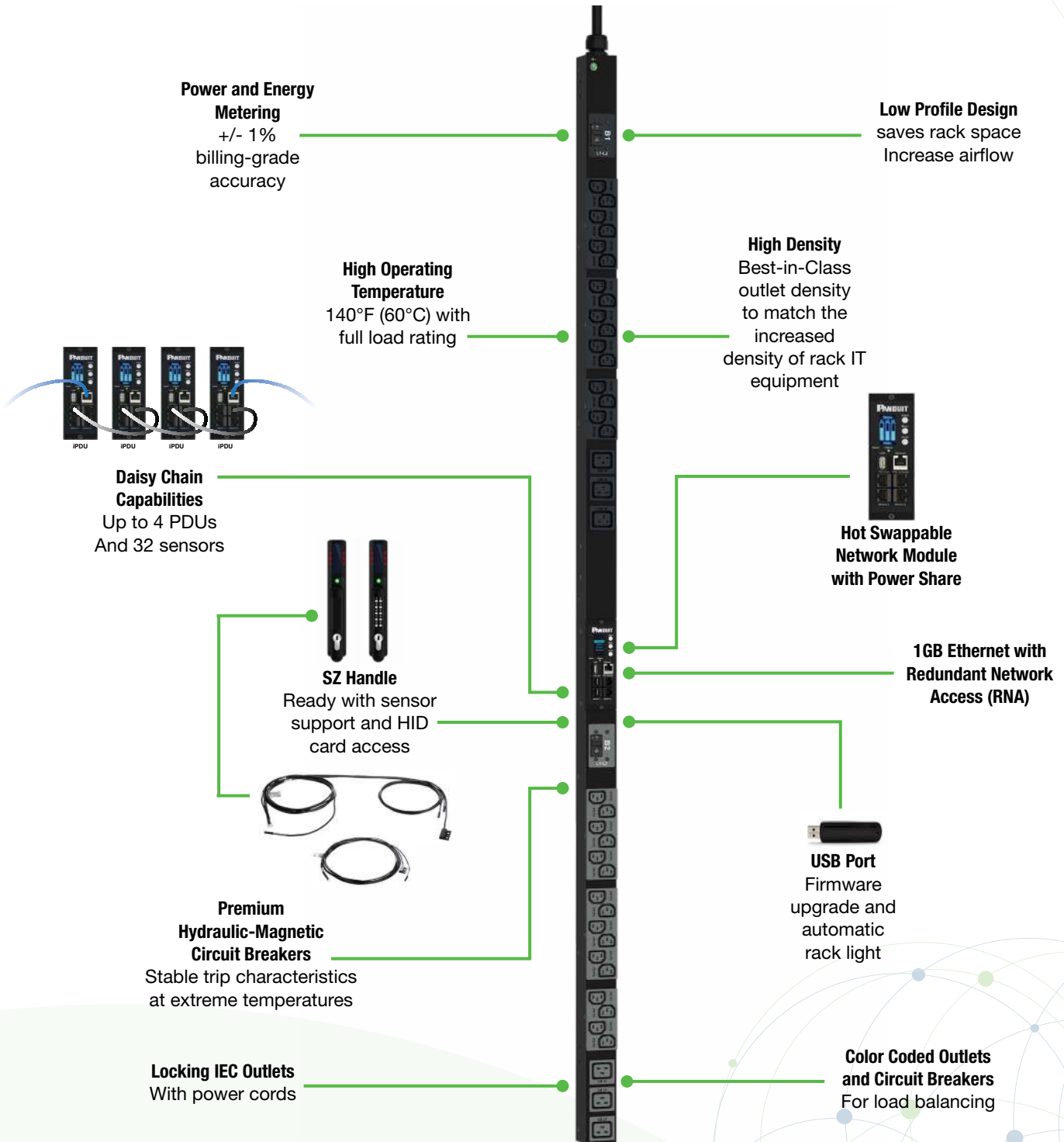

Ordering Information

Part Number	Form Factor	# of CB's	Apparent Power (kVA)	Input Current per Phase	Input Phase	Input Plug Type	Input Voltage Range	Phase Connection	Outlet Count	Outlet Type
Basic Power Distribution Units (Non-Network)										
P12B01M	1U	0	1.4	15	1	NEMA 5-15P	100-120VAC	Single Phase, L-N	12	(12)5-20R
P22B10M	0U HALF	0	3.3	20	1	NEMA L6-20P	100-120VAC	Single Phase, L-L or L-N	22	(20)C13, (2)C19
Monitored Input (MI) Power Distribution Units										
P24D07M	0U MID	2	5.0	30	1	NEMA L6-30P	100-120VAC	Single Phase, L-L	24	(20)C13, (4)C19
P38D28M	0U FULL	3	8.6		1	NEMA L21-30P	100-120/200-240VAC, WYE	3 Phase Wye, L-L, L-N	38	(30)C13, (6)C19, (2)5-20R
P24D05M		6	17.3	3	IEC 60309 3P+N+E 6h 30A (IP44)	415VAC	3 Phase Wye, L-L	24	(12)C13, (12)C19	
P36D03M								36	(24)C13, (12)C19	
P24D34M				17.3	60	IEC 60309 3P+E 9h 60A	200-240VAC, DELTA	3 Phase Delta, L-L	24	(12)C13, (12)C19
Monitored Switch (MS) Power Distribution Units										
P36E35M	0U FULL	3	8.6	30	3	NEMA L21-30P	100-120/200-240VAC, WYE	3 Phase Wye, L-L	16	(30)C13, (6)C19
P24E09M						IEC 60309 3P+N+E 6h 30A (IP44)			415VAC	24
P36E04M	0U FULL - Wide	6	17.3	60	3	IEC 60309 3P+E 9h 60A	200-240VAC, DELTA	3 Phase Delta, L-L	36	(24)C13, (12)C19
P24E32M	0U FULL								24	(12)C13, (12)C19

For the complete offering of power distribution units, including Monitored per Outlet (MPO) and Monitored and Switched per Outlet (MSPO) reference the SmartZone™ iPDU Selection Guide found at www.panduit.com/pdu.

To configure your own power distribution unit part number, visit www.panduit.com/configure-pdu.

Locking Power Cords



LPCA11-X

Part Number	Description	Length (Ft.)
LPCA11-X	Dual Locking Power Cord, IEC C14 to IEC C13, 10 Pack, Black.	2
LPCA12-X		4
LPCA13-X		6
LPCA14-X		8
LPCB11-X	Dual Locking Power Cord, IEC C20 to IEC C19, 10 Pack, Black.	2
LPCB12-X		4
LPCB13-X		6
LPCB14-X		8

-X indicates bulk packaged with 10 pieces per package to reduce single-use plastic. Visit www.panduit.com for other colors and lengths.

SmartZone™ G5 Accessories



ACF05 ACF06



ACF10



ACF11



ACF20

Part Number	Description
ACF05	SmartZone™ Security Handle with dual frequency (125 kHz and 13.56 MHz) card reader and integral humidity sensor. All handles feature the base tumbler (TU020X) pre-installed at the factory.
ACF06	SmartZone™ Security Handle with dual frequency (125 kHz and 13.56 MHz) card reader, integral humidity sensor, and keypad for dual authentication. All handles feature the base tumbler (TU020X) pre-installed at the factory.
ACF10	SmartZone™ Security Handle Temperature and Door Sensor. Connects only to ACF05 and ACF06.
ACF11	SmartZone™ Security Handle (3) Temperature and Door Sensor. Connects only to ACF05 and ACF06.
ACF20	SmartZone™ Security Handle to Panduit G5 iPDU harness (JST to RJ45 male).
MA030	SmartZone™ Security Handle Patch Cord Extension (RJ45 female to RJ45 male).
MA031	SmartZone™ G5 iPDU Power Share Patch Cord (RJ45 male to RJ45 male).
EC001	SmartZone™ G5 Three Temperature and One Humidity Sensor for cold aisle applications, for use with PDU controller only.
EA001	SmartZone™ G5 Temperature Sensor for hot aisle applications, for use with PDU controller only.

Data Center Infrastructure Management for the Hybrid IT

SmartZone™ Cloud Software is our next generation DCIM solution. A true cloud-native platform, built from the ground up to take advantage of cloud flexibility and scalability as well as enhanced manageability, security, and operations ease of use and efficiency to manage Data Center, Enterprise, and Edge infrastructures. Supports the management, monitoring, and alerting for power, cooling, environmental, IT, and connectivity.



Although SmartZone™ Cloud is agnostic and supports multiple vendor IT and facilities devices, it tightly aligns with Panduit SmartZone™ G5 Intelligent PDU and SmartZone™ UPS product lines, to visualize rack-level power, environment, and cabinet physical security access, enabling a single pane of glass to manage the entire data center infrastructure resources. In addition to floorplan layout and rack elevation, power path visualization enables operators to identify a single point of failure, reduce overprovisioning, and assess risk.



APPLICATION



ASSET TRACKING



POWER ACCESS



CABINET ACCESS



ENVIRONMENTAL MONITORING

SmartZone™ Cloud is a self-serviced solution which eliminates the need for professional services and with our open REST APIs that have all product functionality documented, customers can easily integrate with existing applications such as CMDB, ITSM, BMS, and ticketing system. This ensures a solution that is quick to deploy, intuitive to use, and simple to maintain.

Part Number	Description
SZC-PEIA3Y	3-year subscription per power and environmental infrastructure asset (UPS, RPP/PDU, rack POU, cooling, etc.)
SZC-ITIA1Y	1-year subscription per IT infrastructure asset (IT rack, server, storage, network, etc.)
SZC-ITIA3Y	3-year subscription per IT infrastructure asset (IT rack, server, storage, network, etc.)
SZC-QSTART	Quick Start Service, 12-hour remote service

For more information visit www.panduit.com/dcim

FiberRunner® Accessories



Adjustable Ladder QuickLock™ Bracket
 4x4: [FR6ALB](#)
 6x4: [FR6ALB](#)
 12x4: [FR12ALB](#)



Corrugated Loom Tube Slit Wall
 1.5" (38mm) x 10' (3.0m)
 Yellow: [CLT150F-X4F](#)
 Black: [CLT150F-X20](#)



New Threaded Rod QuickLock™ Bracket
 4x4: [FR6TRBN12](#)
 6x4: [FR6TRBN12](#)
 12x4: [FR12TRBN58](#)



12x4 to 6x4 FiberRunner® Reducer Fitting
[FRF126LSYL](#)
Optional Split Cover
[FRF126SCLYL](#)



2-Piece Ladder Rack Bracket 1/2" Threaded Rod
[F2PCLB12](#)



6x4 to 4x4 FiberRunner® Reducer Fitting
[FRF6FR4LYL](#)



Ladder Rack QuickLock™ Bracket
 4x4: [FR6LRB](#)
 6x4: [FR6ALB](#)



6x4 FiberRunner® to 4x4 Fiber-Duct™ with Cover
[FRF64YL](#)
Optional Split Cover
[FRF6FR4SCLYL](#)



Adjustable Cabinet QuickLock™ Bracket
 4x4: [FR6ACAB](#)
 6x4: [FR6ACAB](#)
 12x4: [FR12ACAB](#)



6x4/4x4 2-Port Spillout
[FIDT4X4LBL](#)



Existing Threaded Rod QuickLock™ Bracket
 1/2" Threaded
 4x4: [FR6TRBE12](#)
 6x4: [FR6TRBE12](#)
 5/8" Threaded
 4x4: [FR6TRBE58](#)
 6x4: [FR6TRBE58](#)
 12x4: [FR12TRBE58](#)



2x2 1-Port Spillout
[FIDT2X2LYL](#)



FiberRunner® Side Clamps
[FRQMC-X](#)



Transition Fittings
 4x4 to 4x4: [FRADC4X4BL](#)
 6x4 to 6x4: [FRADC6X4YL](#)
 12x4 to 12x4: [FRADC12X4BL](#)

Wire Basket Overhead Cable Tray Routing System

The Wire Basket Cable Tray Routing System is designed to route and manage copper data, fiber optic, or power cables within data centers, connected buildings, and industrial automation applications. Innovative features provide quick, safe, and easy assembly for reduced installation costs and faster deployment.

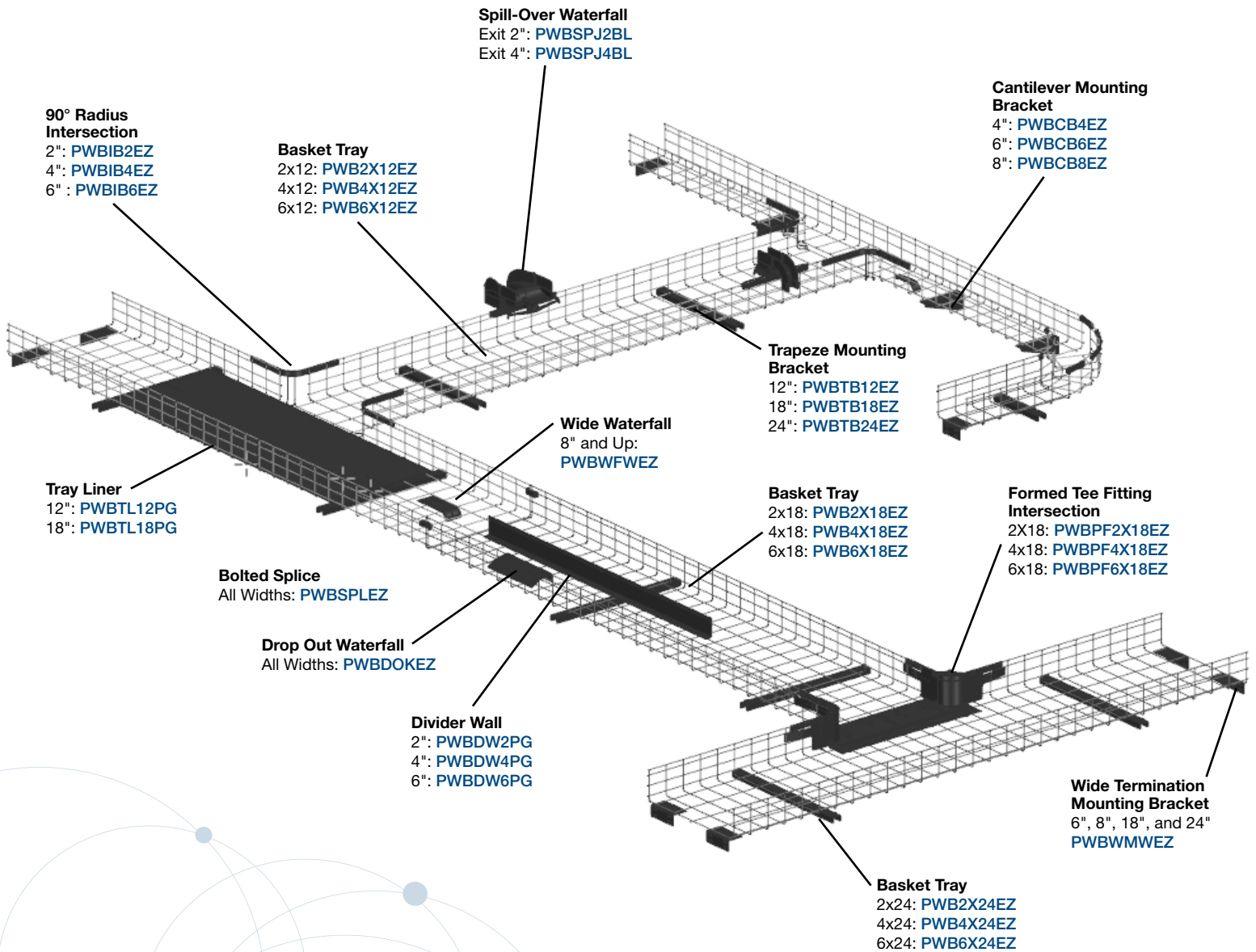

Wire Basket is available in Black, White, and Electro Zinc

Ordering Process

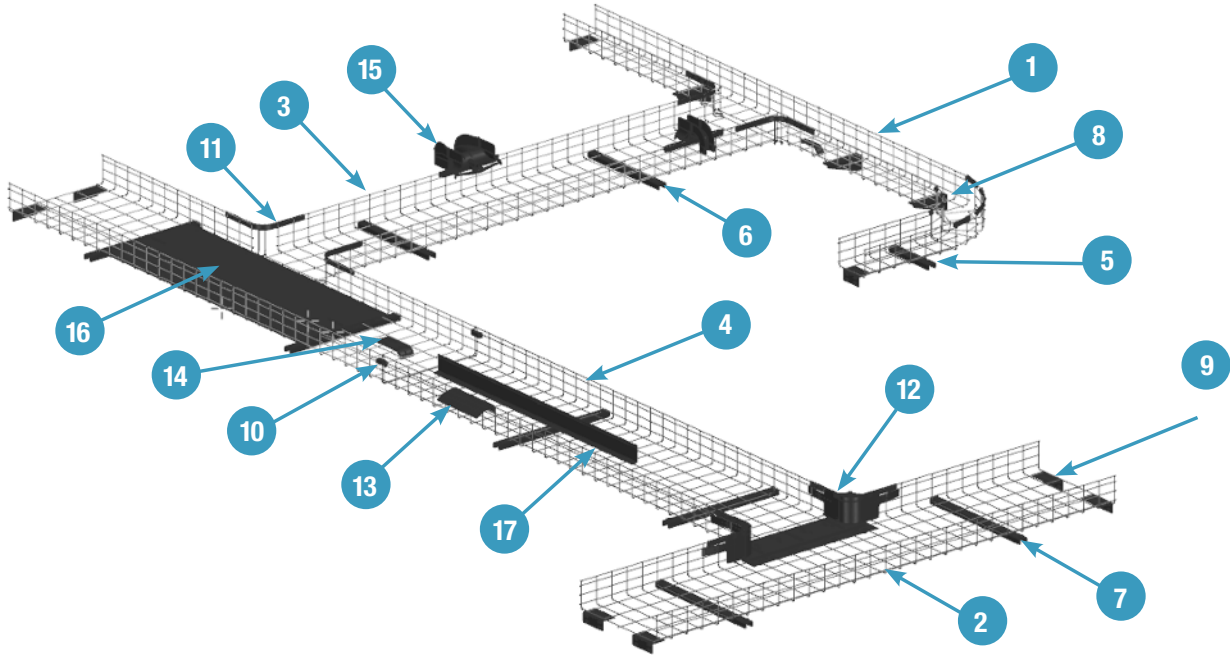

1. Select Your Basket Tray Size

	Basket Height	Basket Width	Color
PWB	2 = 2 inch	X4 = 4 inch	BL = Black WH = White EZ = Electro Zinc
	4 = 4 inch	X6 = 6 inch	
	6 = 6 inch	1 X8 = 8 inch	
		2 X12 = 12 inch	
		3 X18 = 18 inch	
		4 X24 = 24 inch	



2. Select A Mounting Option

	Basket Type	Basket Width	Color
PWB	5 6 7 TB = Trapeze Bracket ¹	4 = 4 inch	BL = Black WH = White EZ = Electro Zinc
	8 CB = Cantilever Bracket ¹	6 = 6 inch	
	WMBV = Vertical Wall Mount Bracket	8 = 8 inch	
	WMN = Narrow Termination Bracket	12 = 12 inch	
	9 WMW = Wide Termination Bracket	18 = 18 inch	
		24 = 24 inch	

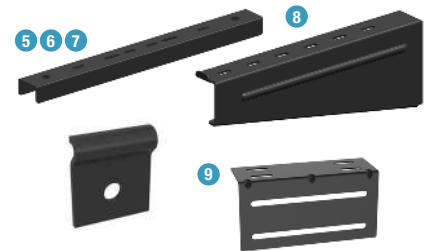

¹Only required for trapeze and cantilever bracket options

3. Select Your Hardware

	Series	Color
PWB	10 SPL = Bolted Splice	BL = Black WH = White EZ = Electro Zinc
	PS = Push-On Splice	
	FES = Expansion Splice	
	TSB = Trapeze Hanging Clip ²	
	SC = Strut Clip ²	
	HK = Hardware Kit Clip ³	

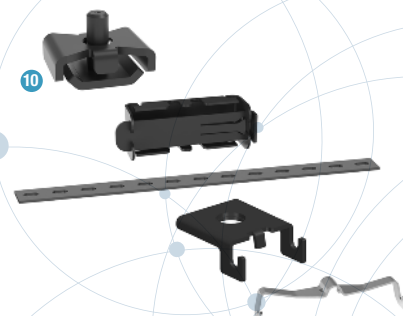

²Available only in electro-zinc plating (EZ)

³Available only in black and electro-zinc (BL and EZ)

4. Configure Your Intersections

	Series	Basket Height Used	Basket Width Used ⁴	Color
PWB	<ul style="list-style-type: none"> 11 IB = 90° Radius Intersection⁴ 12 PF = Formed Tee Fitting 	<ul style="list-style-type: none"> 2 = 2 inch 4 = 4 inch 6 = 6 inch 	<ul style="list-style-type: none"> X4 = 4 inch X6 = 6 inch X8 = 8 inch X12 = 12 inch X18 = 18 inch X24 = 24 inch 	<ul style="list-style-type: none"> BL = Black WH = White EZ = Electro Zinc

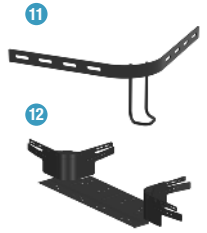

⁴Skip this for IB series part numbers (not required)

5. Add Your Waterfalls

	Series	Color
PWB	<ul style="list-style-type: none"> 13 DOK = Drop Out Kit WFN = Narrow Waterfall 14 WFW = Wide Waterfall SPJ2 = Spill-Over Exit 2"⁵ 15 SPJ4 = Spill-Over 4"⁵ 	<ul style="list-style-type: none"> BL = Black WH = White EZ = Electro Zinc



⁵Available only in black (BL)

6. Select A Tray Liner

	Series	Basket Width Used	Color
PWB	16 TL = Tray Liner	<ul style="list-style-type: none"> 4 = 4 inch 6 = 6 inch 8 = 8 inch 12 = 12 inch 18 = 18 inch 24 = 24 inch 	<ul style="list-style-type: none"> BL = Black WH = White PG = Pre-Galvanized

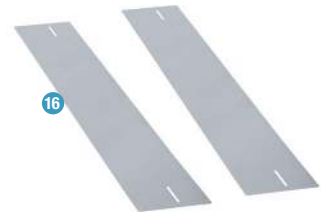

7. Select A Divider Wall

	Series	Basket Width Used	Color
PWB	17 DW = Divider Wall	<ul style="list-style-type: none"> 2 = 2 inch 4 = 4 inch 6 = 6 inch 	<ul style="list-style-type: none"> BL = Black WH = White PG = Pre-Galvanized



Commonly Ordered Part Numbers

Basket Trays

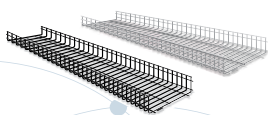

Part Number	Basket Height	Basket Width	Color
PWB2X24EZ	2"	24"	Electro Zinc
PWB4X12BL	4"	12"	Black
PWB4X18EZ	4"	18"	Electro Zinc

Mounting Brackets



Part Number	Basket Height	Support Width	Color
PWBTB12EZ	Trapeze	12"	Electro Zinc
PWBCB18BL	Cantilever	18"	Black
PWBWMBVBL	Wall Mount Vertical	Supports All Widths	Black
PBWMNEZ	Narrow Termination	Supports 4" and 12"	Electro Zinc
PBWMWEZ	Wide Termination	Supports 6", 8", 18", and 24"	Electro Zinc

Hardware



Part Number	Basket Height	Support Width	Color
PWBSPLBL	Bolted Splice	Supports All Widths	Black
PWBPSEZ	Push on Splice	Supports All Widths	Electro Zinc
PWBTSBEZ	Trapeze Hanger Clip	Supports 4", 6", 8", and 12"	Electro Zinc
PWBSCZEZ	Strut Clip	Supports All Widths	Electro Zinc
PWBHKBL	Hardware Kit Clip	Supports All Widths	Black

Intersection

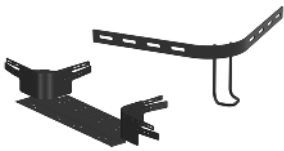

Part Number	Series	Basket Height	Support Width	Color
PWBIB2BL	90° Radius Intersection	2"	Supports All Widths	Black
PWBPF4X12EZ	Formed Tee Intersection	4"	12"	Electro Zinc

Waterfall



Part Number	Basket Height	Support Width	Color
PWBDOKBL	Drop Out Kit	Supports All Widths	Black
PWBWFNEZ	Narrow Waterfall	Supports All Widths	Electro Zinc
PWBWFVBL	Wide Waterfall	Supports 8" and up	Black
PWBSPJ2BL	Spill-Over Exit 2"	Supports All Widths	Black
PWBSPJ4BL	Spill-Over Exit 4"	Supports All Widths	Black

Tray Liner



Part Number	Service	Support Width	Color
PWBTL12BL	Tray Liner	12"	Black
PWBTL18PG	Tray Liner	18"	Pre-Galvanized

Divider Wall

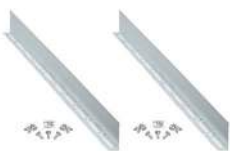

Part Number	Service	Support Width	Color
PWBWDW2BL	Divider Wall	2"	Black
PWBWDW4PG	Divider Wall	4"	Pre-Galvanized

For a full listing of selections, please view the [Wire Basket Cable Tray Routing System Application Guide](#). Check out the features and benefits of the Wire Basket Cable Tray Routing System [here](#).

Fiber Connectivity

1. Chose your connectivity application solution (A or B below).
2. Build your chosen solution from components on the following pages.

A. Duplex Example (10G-10G), 40G BiDi, 4, 8, 16, 32G Fiber Channel SAN App

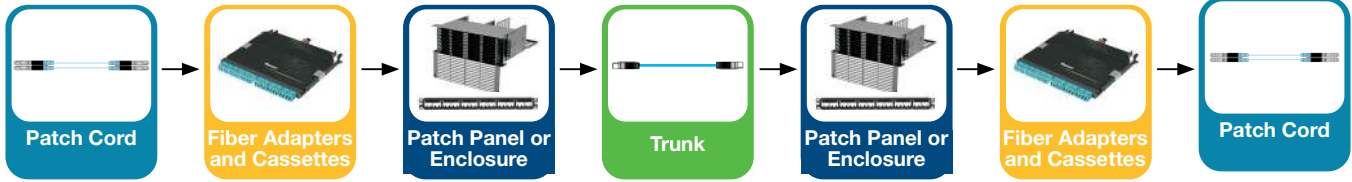

B. Parallel Example (40G-10G), (100G-25G)

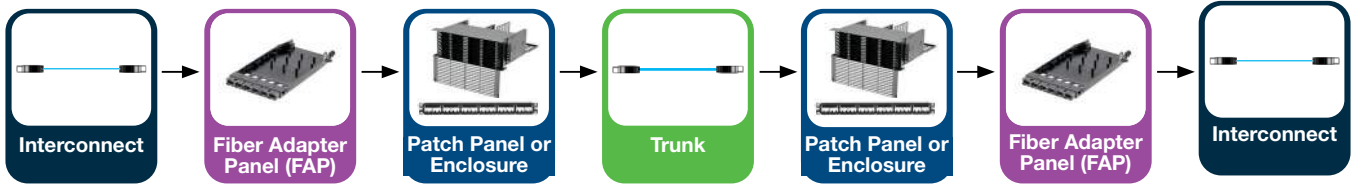

Fiber Adapters and Cassettes

HD Flex 4 to 1 Breakout Cassettes



Part Number	Type	Connectors	Fiber Type	Performance, Polarity
FHC39N-08H-10A	4-port Cassette	1 MPO to 4 Duplex LC	OS2	Standard IL, Method A
FHC3ZO-08H-10B			OM4	Optimized IL, Method B
FHC39N-08-10AN	6-port Cassette		OS2	Standard IL, Method A
FHC3ZO-08-10BN			OM4	Optimized IL, Method B
FHC39N-24H-10A	12-port Cassette	3 MPO to 12 Duplex LC	OS2	Standard IL, Method A
FHC3ZO-24H-10B			OM4	Optimized IL, Method B

HD Flex 12 to 8 Fiber Conversion Cassettes



Part Number	Type	Connectors	Fiber Type	Performance, Polarity
FH4ZU-24-NMNMA	24 fiber, 6-port Cassette	3x MPO8 to 2x MPO12	OM4	Ultra Low Loss IL, Method A
FH4ZU-24-NMNMB				Ultra Low Loss IL, Method B
FH4ZU-48-NMNMA	48 fiber, 6-port Cassette	6x MPO8 to 4x MPO12		Ultra Low Loss IL, Method A
FH4ZU-48-NMNMB				Ultra Low Loss IL, Method B

HD Flex Mesh (Leaf-Spine) Cassettes



Part Number	Type	Connectors	Fiber Type	Performance
FHM9N-32-M	32 fiber, 6-port Cassette	4x MPO8 to 4x MPO8	OS2	Standard IL
FHMZO-32-M			OM4	Optimized IL

The HD Flex™ Fiber Cabling System is designed to fit up to 144 fibers into a single RU

HD Flex™ High Density Fiber Cassettes



CASSETTES



FAP

Part Number	Type	Connectors	Fiber Type	Performance, Polarity
FHC9N-12-10U*	6-port Cassette	1 MPO to 6 Duplex LC	OS2	Standard IL, Universal
FHS9N-12-10N*		6-port LC Duplex Splice/No Pigtailed		N/A
FHS9N-12-10P*		6-port LC Duplex Splice/12 Pigtailed		Standard IL
FHCZO-12-10U*		1 MPO to 6 Duplex LC	OM4	Optimized IL, Universal
FHSXN-12-10N*	6-port LC Duplex Splice/No Pigtailed	6-port LC Duplex Splice/12 Pigtailed	OM3/OM4/OM4+	N/A
FHSZO-12-10P				Optimized IL
FHMP-6-ABL	FAP	6-port MPO	N/A	Type A (Key Up, Key Down)

*4 and 12 port cassettes are also available

Wall Mount Fiber Splice Enclosure



FWMHSSGS-3456

Part Number	Description	Individual Fibers	Ribbon Fibers
FWMHSSGS-3456*	Fiber wall mount hyperscale splicing solution Grey, with split doors - 3,456 fibers.	1,152	3,456
FWMHSSGS-6912*	Fiber wall mount hyperscale splicing solution Grey, with split doors - 6,012 fibers.	2,304	6,912

* Also available in White and Black - change the G to a W for White or a B for Black

Direct Attach Copper (DAC) Cable Assemblies



PQSF2PXA3MBL

Part Number	Type	Length	Cable AWG	Cable Color
PSFP2ZA3MBL	25G SFP28	3*	30 AWG	Black**
PQSF2PXA3MBL	100G QSFP28			
PHQ4SFP2A3MBL	100G QSFP28 to 4x SFP28			

* Available in lengths from 1 to 5 meters

** Available in Black (BL), Blue (BU), Red (RD), White (WH)

HD Flex™ High Density Fiber Enclosures



FLEX1U06

Part Number	Cassettes/FAP Capacity	Cassette Type	Rack Units (RU)	Max Fiber Capacity
FLEX1U06*	12	6 Port	1	144
FLEX2U06*	24		2	288
FLEX4U06*	48		4	576

* Change 06 with 04 to use 4-port cassettes or to 12 to use 12-port cassettes

HD Flex™ High Density Fiber Accessories



FLEX-PLATE1U



FLEX-CM12S

Part Number	Description
FLEX-PLATE1U	HD Flex™ Enclosure Trunk Slack Plate – 1 RU.
FLEX-PLATE4U	HD Flex™ Enclosure Trunk Slack Plate – 4 RU.
FLEX-CM12S	HD Flex™ Universal Rear Cable Manager, 12-position transition managers with a screw mount bracket.
FLEX-CM18S	HD Flex™ Universal Rear Cable Manager, 18-position transition managers with a screw mount bracket.

Fiber Trunk Assemblies



FYZWP77Y005F100



FYZAP77Y005F100

Part Number	Fiber Type	Fiber Count	Jacket Type	Connectors	Polarity	Length (Ft.)
FYZTP77Y005F100*	OM4	12	Plenum (OFNP)	PanMPO™ Female to PanMPO™ Female with 1m breakouts, pulling eye end A	Method B, Optimized IL	100
FYZUP77Y005F100*		24				
FYZWP77Y005F100*		48				
FYZXP77Y005F100*		72				
FYZYP77Y005F100*		96				
FYZAP77Y005F100*		144				



FY9TP77B005F100



FY9AP77B005F100

Part Number	Fiber Type	Fiber Count	Jacket Type	Connectors	Polarity	Length (Ft.)
FY9TP77B005F100*	OS2	12	Plenum (OFNP)	PanMPO™ Female to PanMPO™ Female with 1m breakouts, pulling eye end A	Method B, Standard IL	100
FY9UP77B005F100*		24				
FY9WP77B005F100*		48				
FY9XP77B005F100*		72				
FY9YP77B005F100*		96				
FY9AP77B005F100*		144				



Part Number	Fiber Type	Fiber Count	Jacket Type	Connectors	Polarity	Length (Ft.)
F8BNNM5E5EAAM100*	OS2 Indoor/Outdoor Rollable Ribbon	144	Riser (OFNR), LSZH, and Euroclass Cca	MPO Female to MPO Female with 1m breakouts, pulling eye end A	Method A, Standard IL	100
F8NNM5E5EAAM100*		288				
F8ONM5E5EAAM100*		576				
F8RNM5E5EAAM100*		864				

Fiber Interconnects



Part Number	Fiber Type	Fiber Count	Jacket Type	Connectors	Polarity	Length (Ft.)
FRZTP77Y001F001*	OM4	12	Plenum (OFNP)	PanMPO™ Female to PanMPO™ Female	Method B Standard IL	1
FRZTP77Y001F002*						2
FRZTP77Y001F003*						3
FRZTP77Y001F005*						5



Part Number	Fiber Type	Fiber Count	Jacket Type	Connectors	Polarity	Length (Ft.)
FR9TP77B001F001*	OS1/2	12	Plenum (OFNP)	PanMPO™ Female to PanMPO™ Female	Method B Standard IL	1
FR9TP77B001F002*						2
FR9TP77B001F003*						3
FR9TP77B001F005*						5

*The last 3 digits indicate length. Fiber interconnects and assemblies are available in lengths 001 to 300 feet.

Pre-labeled fiber interconnects all come standard with *RapidID* labels for easy installation and identification. To learn more about our *RapidID* offering, please visit [page 31](#).

For additional fiber application solutions and components, reference the [Data Center Connectivity Guide](#).

Uniboot Patch Cords



Part Number	Fiber Type	Fiber Count	Cable Type (mm)	Jacket Type	Connectors	Polarity	Length (m)
FZ2RPU1U1ONM001	OM4	2	2	Riser (OFNR)	LC Duplex to LC Duplex	Standard IL	1
FZ2RPU1U1ONM002							2
FZ2RPU1U1ONM003							3
FZ2RPU1U1ONM005							5
F92RPU1U1ONM001	OS2	2	2		LC Duplex to LC Duplex	Standard IL	1
F92RPU1U1ONM002							2
F92RPU1U1ONM003							3
F92RPU1U1ONM005							5

To configure your own fiber patch cords, visit www.panduit.com/configure-fiber-patch-cord.

Pre-labeled fiber patch cords all come standard with *RapidID* labels for easy installation and identification. To learn more about our *RapidID* offering, please visit [page 31](#).

Indoor-Outdoor Ribbon Cables (Bulk Fiber Cable)



Part Number	Cable Construction	Fiber Type	Fiber Count	Jacket Type	
FFCDBX144-28M	Indoor-Outdoor Cable, Flexible Ribbon, MT	OS2	144	Riser (OFNR) LSZH, and Euroclass Cca	
FFCDBX288-28M			288		
FFCCBX288-24F	Indoor-Outdoor Cable, Flexible Ribbon, FT				
FFCDBX432-28M					432
FFCDBX576-29M					576
FFCDBX864-29M	864				

Opticore® Armored Fiber Cable and Trunks

When conduit is full, individual armored fiber cabling can be utilized between MMR and MDF or any areas outside of the tenant cages in a Multi-Tenant Data Center. These Indoor fiber cables feature Interlocking Aluminum Armor that offers protection from physical damage and ensures the security of the data running over the fiber. The aluminum armor eliminates the need for inner duct or conduit and improves crush resistance. These cables are available as either OM4 or OS2 fiber in both plenum and LSZH flame ratings.

Pre-Terminated Armored Trunks

Panduit offers customized pre-terminated trunks using indoor or indoor/outdoor interlocking armored bulk fiber cables. They are available pre-terminated on one or both ends with either LC or MPO connectors, and include a pulling eye for ease of installation. Common fiber counts are 8, 12, and 24, but are available up to 144 fibers.



F0PPZ12Y



FSP924Y

Part Number	Environment	Fiber Count	Fiber Type	Armor
F0PPZ12Y*	Indoor Tight Buffered	12	OM4	Interlocking Aluminum
F0PPZ24Y*		24		
FSP912Y*		12	OS2	
FSP924Y*		24		

*Available up to 96 fibers with Tight buffered fiber and 144–864 fibers using Rollable Ribbon

RapidID™ Network Mapping System



Cable Documentation. Automated.

Keeping track of patch cord connections can be time-consuming and labor intensive. Labeling, tracing, and troubleshooting are tedious, repetitive, and notoriously prone to human error. All this leads to wasted time, effort, and money.

The available solutions to address these issues are neither practical nor cost-efficient, until now.

RapidID is a software-enabled network mapping system from Panduit, the leading provider of network infrastructure for smart, scalable, and efficient connectivity solutions.

For network engineers and data center managers, RapidID is a practical, affordable alternative to traditional manual approaches. It does not require special panels or cabling, and is ideal for building a new telecom room, locating installed cabling, or replacing a network switch.



Bluetooth®-enabled handheld barcode scanner and pre-labeled cable

Part Number	Description
RPDSCN	RapidID handheld barcode scanner with isolation shield

The RapidID solution includes:

- Pre-labeled copper and fiber patch cords for easy installation and identification
- Feature-rich mobile app
- Bluetooth-enabled handheld barcode scanner



Key Features	Benefits
Patch cords are pre-labeled	Automates labor-intensive and error-prone cable documentation process that can lead to an outage
Easy-to-use scanner	<ul style="list-style-type: none"> • Saves time on tracing, labeling, and documenting • Free-up network engineers to focus on more rewarding and strategic initiatives
Feature-rich mobile app	<ul style="list-style-type: none"> • Reduce time and cost of patch cord documentation by up to 50%* • Control cost and risk associated with cable installation and management

*Panduit internal time study, May 2021.

RapidID...Easy as 1, 2, 3

1 INSTALL

Install Panduit Copper & Fiber Patch cables pre-labeled with unique RapidID barcode labels

2 DOWNLOAD

Download the RapidID application to your device (Mobile, Tablet, or Windows OS)

3 SCAN

Barcodes using the Bluetooth-enabled handheld scanner.



For more information visit www.panduit.com/rapid-id

Meet-Me Room (MMR)

Meet-Me Rooms need to be designed to distribute data center traffic more cost-effectively and efficiently in a safe and secure environment. Distribution frames, splice enclosures, pathways, and fiber assemblies are the main components of the Meet-Me Room and are used to reliably transfer data from ISPs/Carriers to each tenant's cage.



FlexCore™ Optical Distribution Frame Solution

Discover the FlexCore™ ODF, empowering you to optimize floor space, reduce risks, and simplify moves, adds, and changes (MAC).

Page 33



HD Fusion Fiber Wall Mount Splice Enclosure

The Wall Mount Fiber Splice Enclosure houses, organizes, manages, and protects cable to cable fusion splice connections. It can accommodate individual or ribbon fibers. This enclosure features split doors and supports up to 3456 or 6912 ribbon fibers.

Page 28

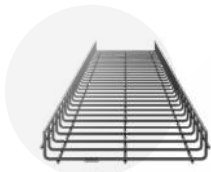

Wire Basket Overhead Cable Tray Routing System

The Wire Basket Cable Tray Routing System is designed to route and manage copper data cables, fiber optic, or power cables within data centers.

Page 23



Opti-Core® Uniboot Patch Cords

Ideal for high density applications, the Uniboot fiber patch cord features a small 2mm unitary cable with a push-pull boot that provides easier access to insert/remove without disturbing adjacent circuits.

Page 30



Bulk Fiber Cable

The indoor-outdoor features of this cable make it an excellent choice for building-to-building cable connections, eliminating the need for intermediate splice transitions from the outdoor environment to indoor use.

Page 30



RapidID™ Network Mapping System

RapidID is a software-enabled network mapping system that simplifies network documentation and data center audits.

All Panduit fiber optic patch cords are RapidID-enabled.

Page 31



FlexCore™ Optical Distribution Frame

Optical distribution frames (ODF's) are an all-important network element at the heart of the fiber network. Representing <5% of a typical IT project investment, high density, performance, and quality are pivotal attributes for an ODF ensuring business continuity 24/7/365.

Offering the Ultimate in Flexibility, Manageability, Scalability, and Security

- Highly intuitive cable routing paths remove guesswork and prevents 'rip and replace' costs
- Innovative cable management and lockable vertical cable manager doors eliminate circuit risk and downtime
- Up to 3,168 fibers per frame when using standard 24 fiber cassettes
- Data center floor space can be reduced by 50%*
- Simplifies and reduces the time for moves, adds, and changes
- Multiple form factor (width) cassettes optimize rack space across wider applications
- Patch cords consolidated to a single length — freeing up capital locked in maintaining inventory
- Multi-layer security with lock capability available at both 4 RU enclosure and ODF doors

Common Frame Arrangements

Single Cross Connect Frame, recommended patch cord length 4m



Double Cross Connect Frame, with end panels, recommended patch cord length 4m



Cross Connect, four frame line-up, with end panels and over-length storage (300mm wide intermediate VCM). Recommended patch cord length between two double frames is 10m



Double Cross Connect Back-to-Back, fully enclosed. Recommended patch cord length 4m



Interconnect or Splice Through frame with end panels

Optimal Locations to Implement include:

- ✓ Building Entry
- ✓ Meet-Me Room (MMR)
- ✓ Main Distribution Area (MDA)
- ✓ Intermediate Distributed Area (IDA)

The FlexCore™ Optical Distribution Frame can be installed in additional optimal locations.

*Assumes 4 double frames (2 double frames in a 'back-to-back' arrangement). Design conditions and configuration specifics apply.

Step 1: Select a Frame

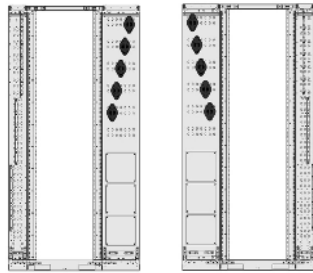

Single Frame Cross Connect (LH) **OR** Assemble as opposite hand (RH)

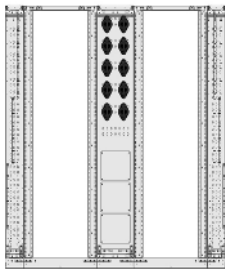

Double Frame (Compact) Cross Connect

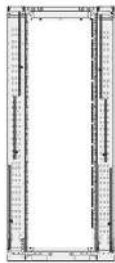

Splice Through **OR** Interconnect

Description	QTY	Part Number*	Maximum Capacity**	Dimensions (mm) ^{††}
Frame 600mm VCM 150mm VCM 300mm Spool Kit (x6)	1 [†] 1 [†] 1 [†] 1 [†]	FDF45GY FDFVCM1545GY FDFVCM3045GY FDUSP6	3168F per single frame 132 x 24F (LC) Cassettes 11 x 4RU Enclosures 12 Trays per 4RU Enclosure	Height – 2133 (2159-2200 with leveling feet) Width – 1050 Depth – 300
Frame 600mm VCM 150mm VCM 300mm Spool Kit (x6)	2 2 1 2	FDF45GY FDFVCM1545GY FDFVCM3045GY FDUSP6	6336F per double frame 132 x 24F (LC) Cassettes 11 x 4RU Enclosures 12 Trays per 4RU Enclosure	Height – 2133 (2159-2200 with leveling feet) Width – 1800 Depth – 300
Frame 600mm VCM 150mm	1 2	FDF45GY FDFVCM1545GY	6336F Splice only – Ribbon 3168F Splice only – shrink down (single fiber) 3168F Interconnect (LC Cassette) 11 x 4RU Enclosures 12 Trays per 4RU Enclosure	Height – 2133 (2159-2200 with leveling feet) Width – 900 Depth – 300

Duplex LC patch cords must be <2mm outside diameter unitary cable (Uniboot patch cord)

Frames are supplied with leveling feet and wall mount bracket.

150mm VCM illustrated is supplied with 4 x cable management plates

Refer to design guides for configuration specifics

VCM can be assembled for top (as illustrated) or bottom cable entry/exit.

[†]for a 2100mm wide double cross connect frame (where both LH + RH version is needed) double quantity shown

^{††}Width and depth stated excludes end panel(s) and door(s)

*Change “GY” to “BL” in part number for black.

**maximum fiber capacity (stated) applies to single, double and quad (quad = double frame placed back-to-back) frame arrangements in combination with 24F LC cassettes. If using a line-up of >2 frames side by side the maximum number of 4RU enclosure is 10 off (2880F per frame) to allow bottom patch cord pass-through (trough) to be used.

Step 2: Select a Surround

LH - Left Hinged
RH - Right Hinged

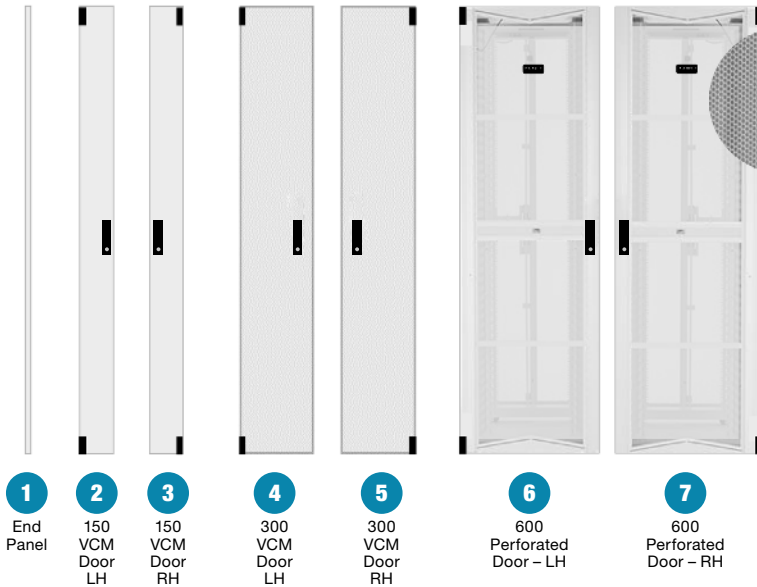

Ref.	Part Number**	Description
1	FDFEP45GY	*End Panel
2	FDUFD1545SLGY	150mm VCM Door LH
3	FDUFD1545SRGY	150mm VCM Door RH
4	FDUFD3045SLGY	300mm VCM Door LH
5	FDUFD3045SRGY	300mm VCM Door RH
6	FDUFD6045PLGY	600mm Perforated Door LH
7	FDUFD6045PRGY	600mm Perforated Door RH

*for multi-rack lineups an end panel is only required at the end of each row

**change "GY" to "BL" in part number for the part in black

Step 3: Select a FlexCore™ Enclosure

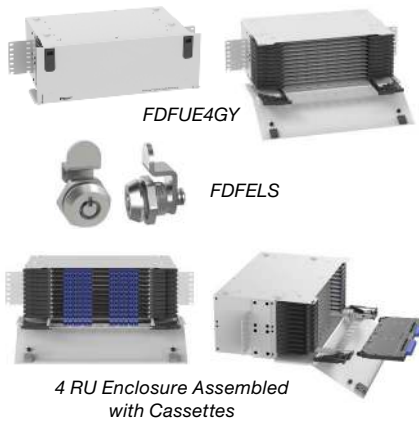

Part Number	Description
FDFUE4GY	ODF Front Access Universal Enclosure, 4RU, Gray
<i>Change "GY" to "BL" in part number for black</i>	12 x Slide out trays
FDFELS	Enclosure Locking Kit
	Standard, Keyed Alike
	Each it supplied with two locks

Additional Items to Order

FlexCore™ Cassettes



FlexCore™ LC Splice Cassettes

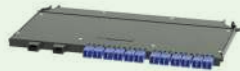

FlexCore™ Splice Through (cable-cable) Cassette



FlexCore™ MPO-LC Cassettes



FlexCore™ Tethered Cassette

FlexCore™ Accessories



Patch Cords



For more information visit
www.panduit.com/flexcore-odf

Gray Space Solutions

Outside the Cage

To support data centers, the gray space consists of many products that support back-end function allowing the white space to continue to function smoothly and safely. Absence of Voltage Testers, cable cleats, switch gear, and various other products build an infrastructure that increases safety, reduces risk to workers, and saves unnecessary downtime by using innovative electrical solutions within data center gray space.

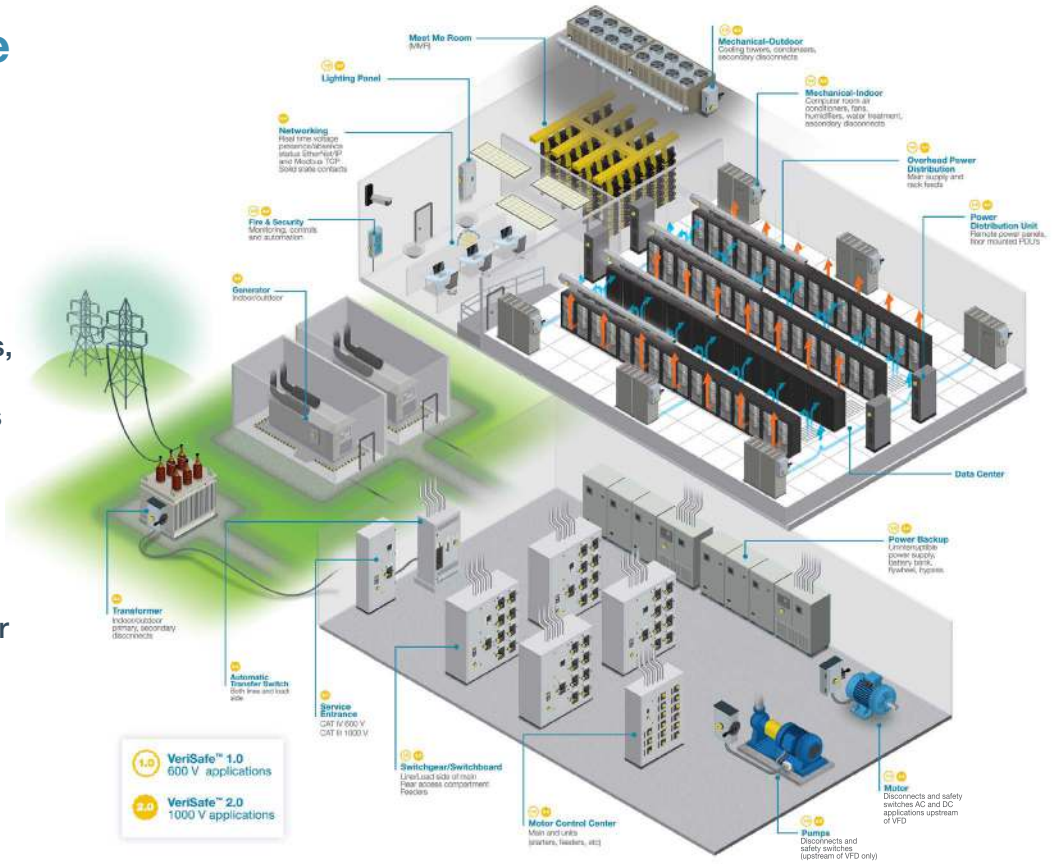

VeriSafe™ Absence of Voltage Tester

The VeriSafe™ Absence of Voltage Tester minimizes risk by verifying the absence of voltage before equipment is accessed, making it easier for workers to verify an electrically safe work condition has been established in a fraction of the time compared to using hand-held portable test instruments.



Part Number	Power Specifications	System Cable Length (Ft.)	Sensor Lead Length (Ft.)
VeriSafe™ Absence of Voltage Testers			
VS-AVT-C02-L03	1, 2, or 3-phase AC or DC systems up to 600 V	2	3
VS-AVT-C08-L10		8	10



Part Number	Power Specification	System Cable Length (Ft.)	Sensor Lead Length (Ft.)
VeriSafe™ 2.0 Absence of Voltage Testers			
VS2-AVT-1PB-08	Single-phase AC or DC systems up to 1,000	8	10
VS2-AVT-1PF-08			
VS2-AVT-3PB-08	Three-phase AC or DC systems up to 1,000 V		
VS2-AVT-3PF-08			



Part Number	Conductor Gauge AWG	No. of Connectors	No. of AVTs Kit can be Installed With
Sensor Lead Connection Kits			
VS-CKP14-6	14 to 6	3	1
VS-CKP4-000	4 to 3/0		
VS-CKP1K4/0-500*	4/0 to 500MCM		

*Rated for 1KV installations

Part Number	Description
Accessories	
VS-ACK-BATTERY	Battery pack for use with VeriSafe™ Access Control Kit (VS-ACK-CPWR).

Cable Cleats

To protect electrical infrastructure when using power cables in a tray, installing an IEC 61914:2015-compliant cable cleat is the best option when facing a peak short circuit fault. Panduit cable cleat solutions were designed to withstand the stress of a short circuit event using a state-of-the-art ANSYS simulation software to model the dynamic forces at play.



Locking Strap Cable Cleats

Part Number	Trefoil Double Loop Cable Diameter Range				Flat Multicore Double Loop Cable Diameter Range				Width		Thickness		Length	
	From		To		From		To							
	In.	mm	In.	mm	In.	mm	In.	mm	In.	mm	In.	mm	In.	mm
MLT4DH-L	0.472	12	1.654	42	0.472	12	3.740	95	0.31	7.9	0.010	0.25	28.0	711
MLT4DEH15-Q316									0.50	12.7				
MLT4DSH-Q316									0.63	15.9				
MLT4DSH-Q														
MLT6DEH15-Q316	1.654	42	2.835	72	3.740	95	5.906	150	0.50	12.7	0.015	0.38	41.5	1054
MLT6DSH-Q316									0.62	15.9				
MLT6DSH-Q														
MLT8DEH15-Q316	2.835	72	3.937	100	5.906	150	7.677	195	0.50	12.7	0.015	0.38	53.5	1359
MLT8DSH-Q316									0.63	15.9				
MLT8DSH-Q														

Buckle Strap Cable Cleats

Part Number	Trefoil Double Loop Cable Diameter Range				Trefoil Triple Loop Cable Diameter Range				Flat Multicore Double Loop Cable Diameter Range				Width		Thickness		Length	
	From		To		From		To		From		To							
	In.	mm	In.	mm	In.	mm	In.	mm	In.	mm	In.	mm	In.	mm	In.	mm	In.	mm
MS4W75T30-Q6	0.472	12	0.787	20	-	-	-	-	0.472	12	1.772	45	0.75	19.1	0.03	0.76	19.6	498
MS6W75T30-Q6	0.787	20	1.181	30	0.472	12	0.787	20	1.772	45	2.756	70					25.9	658
MS8W75T30-Q6	1.181	30	1.654	42	0.787	20	1.024	26	2.756	70	3.740	95					32.1	815
MS10W75T30-Q6	1.654	42	2.283	58	1.024	26	1.378	35	3.740	95	4.724	120					38.4	975
MS12W75T30-Q6	2.283	58	2.835	72	1.378	35	1.732	44	4.724	120	5.906	150					44.7	1135
MS14W75T30-Q6	2.835	72	3.386	86	1.732	44	2.087	53	5.906	150	6.693	170					50.1	1273

Cushion Sleeves

Part Number	Material	Length		Width		Thickness	
		Ft.	mm	In.	mm	In.	mm
PCSLSH-B-CR	TPE Low Smoke, Halogen Free	100	30.5	1.05	26.8	0.08	2.2
PCSSH-B-CR	MIL-R-6855 Spec Neoprene			0.97	23.1	0.12	3.1

UC Series Mounting Brackets

Part Number	Description
UCSQ1-V316	Strut Type, 316L stainless steel
UCIB1-V316	I-Beam, 316L stainless steel

Aluminum Trefoil Cable Cleats



CCALTR2932-X

Part Number	Cable Diameter Range		Height (H)		Width (W)		Depth (D)		Weight		Mounting Holes
	In.	mm	In.	mm	In.	mm	In.	mm	Lbs.	g	
CCALTR2326-X	0.91 – 1.02	23 – 26	3.94	100	3.98	101	2.17	55	0.81	370	1 x M8
CCALTR2528-X	0.98 – 1.10	25 – 28	4.06	103	4.13	105			0.85	385	
CCALTR2730-X	1.06 – 1.18	27 – 30	4.21	107	3.85	98			0.87	397	
CCALTR2932-X	1.14 – 1.26	29 – 32	4.33	110					0.92	418	
CCALTR3135-X	1.22 – 1.38	31 – 35	1.57	116	3.97	101			0.93	424	
CCALTR3438-X	1.34 – 1.50	34 – 38	4.76	121	4.18	106			0.98	448	
CCALTR3741-X	1.46 – 1.61	37 – 41	4.99	127	4.41	112			1.05	477	
CCALTR4044-X	1.57 – 1.73	40 – 44	5.24	133	4.64	118			1.14	516	
CCALTR4347-X	1.69 – 1.85	43 – 47	5.52	140	4.85	123			1.23	558	
CCALTR4651-X	1.81 – 2.01	46 – 51	5.83	148	5.05	128			1.32	602	
CCALTR5056-X	1.97 – 2.20	50 – 56	6.22	158	5.50	140			1.42	647	
CCALTR5561-X	2.17 – 2.40	55 – 61	6.57	167	5.72	145			1.55	706	
CCALTR6067-X	2.36 – 2.64	60 – 67	7.01	178	6.15	156			1.73	787	
CCALTR6675-X	2.60 – 2.95	66 – 75	7.6	193	6.72	171					

Aluminum Two-Hole Cable Cleats



CCAL2H7083-X

Part Number	Cable Diameter Range		Height (H)		Width (W)		Depth (D)		F		Weight		Mounting Holes
	In.	mm	In.	mm	In.	mm	In.	mm	In.	mm	Lbs.	g	
CCAL2H3846-X	1.50 – 1.81	38 – 46	2.01	51	3.98	101	1.64	42	2.91	74	0.50	226	2 x M10
CCAL2H4658-X	1.81 – 2.28	46 – 58	2.36	60	4.52	115	1.69	43	3.39	86	0.64	291	
CCAL2H5870-X	2.28 – 2.76	58 – 70	2.87	73	5.20	132	1.77	45	3.97	101	0.89	404	
CCAL2H7083-X	2.76 – 3.27	70 – 83	3.39	86	5.71	145	1.81	46	4.48	114	1.09	496	
CCAL2H8397-X	3.27 – 3.82	83 – 97	3.94	100	6.37	162	1.85	47	5.07	129	1.39	630	
CCAL2H97109-X	3.82 – 4.29	97 – 109	4.53	115	3.89	175	1.93	49	5.55	141	1.66	754	
CCAL2H109120-X	4.29 – 4.72	109 – 120	5.04	128	7.33	186	1.98	50	5.99	152	1.92	873	

Aluminum One-Hole Cable Cleats



CCAL1H1013-X

Part Number	Cable Diameter Range		H		W		D		E		S		Weight		Mounting Holes
	In.	mm	In.	mm	In.	mm	In.	mm	In.	mm	In.	mm	Lbs.	g	
CCAL1H1013-X	0.39 – 0.51	10 – 13	0.91	23	1.57	40	1.61	41	0.48	12	0.79	20	0.11	50	1 x M10
CCAL1H1316-X	0.51 – 0.63	13 – 16	1.02	26	1.72	44					0.83	21	0.13	59	
CCAL1H1619-X	0.63 – 0.75	16 – 19	1.14	29	1.88	48					0.91	23	0.15	68	
CCAL1H1923-X	0.75 – 0.91	19 – 23	1.26	32	2.04	52			0.51	13	0.99	25	0.17	77	
CCAL1H2327-X	0.91 – 1.06	23 – 27	1.42	36	2.28	58					1.07	27	0.20	89	
CCAL1H2732-X	1.06 – 1.26	27 – 32	1.57	40	2.44	62	1.65	42	0.55	14	1.19	30	0.24	107	
CCAL1H3238-X	1.26 – 1.50	32 – 38	1.77	45	2.68	68					1.30	33	0.27	125	
CCAL1H3846-X	1.50 – 1.81	38 – 46	2.01	51	2.98	76					1.45	37	0.33	149	
CCAL1H4651-X	1.81 – 2.01	46 – 51	2.36	60	3.26	83					1.58	40	0.40	181	
CCAL1H5157-X	2.01 – 2.24	51 – 57	2.56	65	3.49	89					1.70	43	0.44	202	

Visit www.panduit.com/cable-cleats for the complete cable cleat offering and access the Cleat kAlculator™ to determine which cable cleat is appropriate for your application.

Grounding and Bonding Solutions

Grounding and Bonding Equipment Bonding Jumper Kit



Part Number	MCBN Conductor Size #6-#2 AWG	Description
RGCBNJ660P22	HTCT2-2-1	#6 AWG (16mm ²) jumper; 60" (1.52m) length; 45° bent lug on grounding strip side; provided with .16 oz. (5cc) of antioxidant, two each #12-24 x 1/2", M6 x 12mm, #10-32 x 1/2" and M5 x 12mm thread-forming screws and a copper compression HTAP* for connecting to the MCBN.

Grounding Busbar



Part Number	Description
Grounding Busbar Kits for Threaded Rail Fasteners	
RGRB19U	Grounding busbar; 19" (483mm) length; tin-plated; 20 holes arranged for flexibility in mounting with 20 #12-24 x 1/2" hex head screws installed; mounting hole sets have 5/8" (15.9mm) spacing; provided with two each #12-24 x 1/2", M6 x 12mm thread-forming screws, and two #12 flat washers for mounting.

Grounding Strip



Part Number	Description
RGS134-1Y	Grounding strip; 78.65" (2m) length; .67" (17mm) width; .05" (1.27mm) thickness; provided with .16 oz. (5cc) of antioxidant, one grounding sticker and three each #12-24 x 1/2" and M6 x 12mm thread-forming screws.

Green Bonding Cage Nut Kit



Part Number	Description
CNBK	Green bonding cage nut, includes 50 #12-24 bonding cage nuts (.06 - .11 thick panel) and 50 #12-24 x 1/2" bonding screws with #2 Phillips/slotted combo hex head (use 5/16" or 8mm socket).

Global Subject Matter Expertise

Structure to Ensure Program Consistency Where You Conduct Business

Panduit Account Manager One Customer, One Team

- Serves as your primary point of contact
- Access to professionals focused on your needs
- Expertise across planning deployment and support
- Conducts ongoing needs assessment and planning to ensure program success
- Executes against support and delivery plans

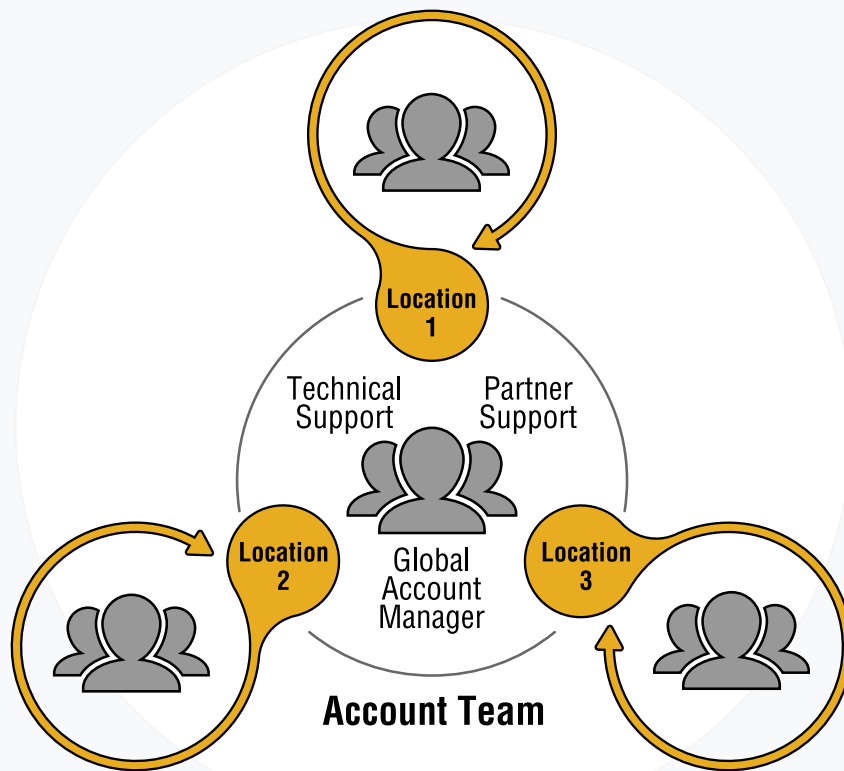

Our most important connection is with you.

We have the knowledge and experience to help you make the most of your infrastructure investment.

Let's connect.

For more information visit www.panduit.com/cloud-infrastructure

The logo for Panduit, featuring the word "PANDUIT" in a bold, black, sans-serif font with a registered trademark symbol (®) to the upper right. The background of the slide is a vibrant green and yellow gradient with a network of white lines and dots.

Panduit Corp.
World Headquarters
Tinley Park, IL 60487

cs@panduit.com
US and Canada: 800.777.3300
Europe, Middle East, and Africa:
44.20.8601.7200
Latin America: 52.33.3777.6000
Asia Pacific: 65.6305.7575

www.panduit.com