

# Deploying Wi-Fi Infrastructure in Healthcare Environments



Mounting Solutions for Wi-Fi Access Points

A division of Chatsworth Products



Explore special considerations for deploying Wi-Fi in healthcare facilities. Discussion includes ICRA compliance, endpoint security, architectural considerations, fire and smoke ratings, and IP67 Ceiling Enclosures.

## Special Considerations

A healthcare facility's top objective is to protect patients, and this includes protection from airborne infectious disease. Dust, mold and spores found in the space above a suspended ceiling, or within walls, are components of airborne infectious disease. Specifically, surgery and immuno-compromised patients should be protected from these components of airborne infectious disease.

Poking holes through ceiling tiles to pass antennas or cables is not acceptable in hospitals, as these openings in the ceiling readily pass dust and spores. Lifting ceiling tiles to service above ceiling access points is restricted due to Infection Control Risk Assessment Procedures (ICRA). Wireless access points should be mounted in an enclosure which permits access to the equipment, and connection to the data cable, without lifting or penetrating the suspended ceiling.

Examples of intrusion into the above-ceiling space



These types of openings in the ceiling tile are undesirable in a healthcare environment.

## *Simplifying ICRA Compliance*

*Oberon enclosures & mounts allow you to perform moves, adds and changes in healthcare facilities without entering the air-handling space*



## Infection Control Risk Assessment (ICRA) Procedures: Challenges

All hospitals have developed procedures for mitigating the spread of infectious disease and contamination in hospitals. These Infection Control Risk Assessment (ICRA) procedures typically specify that areas in which work (such as pulling cable and lifting ceiling tiles) is to be performed must have a barrier in place. They must be negatively pressurized, so dust and spores are not spread through the facility. These procedures will have a serious impact on access point and cabling installation, moves, adds and changes.



To address some of the special considerations of deploying a wireless network in a healthcare environment, the Telecommunications Industry Association has developed TIA 1179 – Healthcare Facility Telecommunications Infrastructure Standard. Among other topics, the standard states the following:

- Once ceiling tiles are closed, adding or changing cabling could jeopardize infection control measures.
- Restrictions on removing ceiling tiles impacts adds, moves and changes, adding significant cost when it becomes necessary to access the ceiling. It is recommended that the wireless environment be characterized prior to design and installation of cabling.
- Policies and procedures to mitigate Airborne Infectious Disease shall be adhered to.
- When ceiling tiles are lifted and work is being performed, the work area shall be tented and negatively pressurized.

**ANSI/BICSI 008-2018, WLAN Systems Design and Implementation Best Practices specifies that APs should be designed and installed so they are accessible for servicing and troubleshooting without need for infectious control protocols.** Furthermore, the document states that the wireless access point infrastructure physical design should consider consistency, compatibility and ease of operational support while lowering overall cost. Design costs should consider both initial installation costs as well as operational costs. The installation should result in minimal operational cost during the lifecycle of the horizontal cable system including cable, components and associated hardware.



## Simplify Compliance with Oberon Mounting Solutions

Oberon enclosures provide access to ceiling-mounted wireless LAN access points and networking equipment without entering the area above the ceiling (the “plenum” space), helping to protect vulnerable patients from airborne contaminants and simplifying compliance with ICRA procedures. Oberon’s recessed hard ceiling mounts permit the access point to be removed without exposing the above ceiling space.



*Oberon Models 1077-CCOAP4800 (closed and open) and 1076-AP335 (open)*

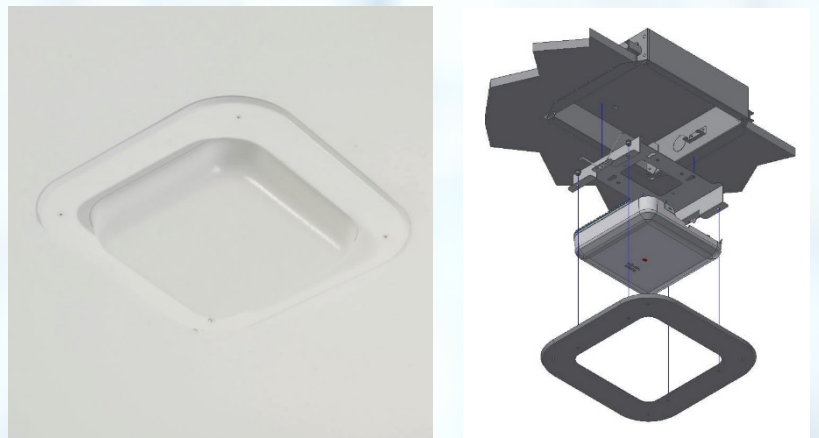

*1042-CCOAP3800 (closed and open)*

## Endpoint Security

All hospitals should implement policies and procedures to limit physical access to its electronic information systems, while ensuring that properly authorized access is allowed. Wi-Fi access points should be physically secured, not only to avoid theft or tampering, but also to deter access to the data connector.

Many of Oberon's enclosures and mounts are lockable, ensuring the wireless infrastructure and associated cabling is secure. The *Healthcare Information Privacy and Portability Act (HIPAA)* paragraph 64.310 Physical safeguards, states: A covered entity must, in accordance with 164.306: (a)(1)

Standard: Facility access controls, implement policies and procedures to limit physical access to its electronic information systems and the facility or facilities in which they are housed while ensuring that properly authorized access is allowed.



1012-00



1015-00



1064-T

*Oberon locking mounts and enclosures (locking right angle bracket (left), surface mount box (Middle), suspended ceiling enclosure (right)).*

## Architectural Considerations

Hospitals are often designed to reflect that values of the community, and whether the hospital is brand new or historically significant, the architectural and aesthetic integrity of the hospital needs to be considered in the pre-design phase. By their very nature, wireless APs are installed on ceilings, high on walls, or other open locations to provide for the best wireless coverage. As such, they are highly visible. The wireless designer needs to consider how the AP will be blended into the environment in a manner that is aesthetically acceptable, without compromising performance.

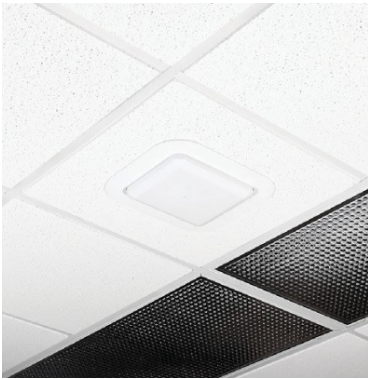

*1040-COAP4800 and 1041-WA*

*Oberon's Envelop™ line of products recess the access point into the suspended ceiling (left) or hard ceiling (right), revealing only the "antenna face" of the access point.*

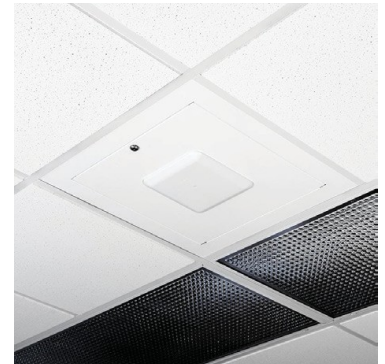

*1047-LPDOME (closed and open)  
and 1047-CCOAP3800-T*

*Oberon's Wi-Tile™ line of products conceal the AP, antenna, and cabling behind a plastic dome (left) or recess the AP flush to the ceiling revealing only the "antenna face" of the access point.*

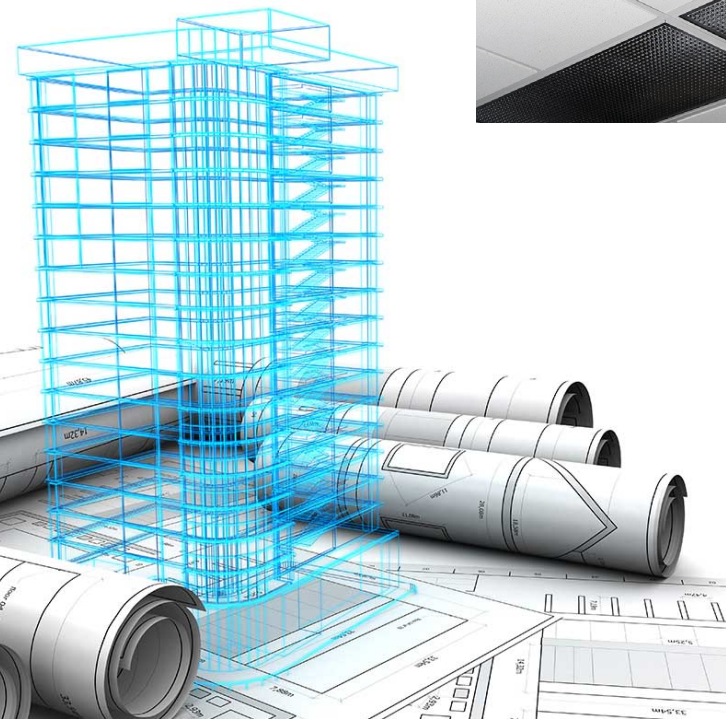



## Fire- and Smoke-Rated Ceilings

Many ceilings act as fire and smoke barriers, and penetrations in such ceilings are restricted. Many of Oberon's ceiling mounted products have a full steel back-box which acts not only as a dust barrier, but also as a smoke and fire barrier. In these products, cable egress is through a firestop grommet, further enhancing effectiveness as a fire and smoke barrier.

Many of Oberon's Ceiling enclosures and recess mounts have a full metal back-box (left) for fire rated ceilings. Cable egress is through a firestop grommet (right).



*1047 LPDOME*



*Firestop Grommet*

## IP67 Ceiling Enclosure

Certain rooms in hospitals are subject to washdown or require an extra degree of isolation between the patient area and plenum or environmental air space above the ceiling.

Oberon offers unique dustproof/watertight ceiling enclosures which protect the enclosed equipment. Gasketed dual band antennas mounted on the hinged door are connected to internal access points.

Oberon's Model 1028 Series access point enclosures are IP67 rated, for protecting wireless access points in hard ceilings (left) and suspended ceilings (right).



*1028-08-ANT5-B*



*1028-08-ANT5-F*





## Deploying Temporary or Permanent Wi-Fi Networks Outside the Facility

Hospitals will frequently provide outdoor Wi-Fi in entry ways, parking lots and garages, screening areas, and outdoor patient areas. While outdoor Wi-Fi networks typically engage APs with extended temperature ranges, it is desirable to protect, secure and conceal the access point and associated cabling, connectors and antennas. These outdoor Wi-Fi networks may be temporary installations for events or screening areas, or they may be permanently installed.

Oberon offers a wide variety of rugged, NEMA-4 (waterproof) low-loss plastic Skybar™ enclosures and NetPoint™ wireless bollards for APs and antennas from every vendor.





**1020 Series** - Oberon's most compact Skybar NEMA-4 enclosure conceals and protects APs with embedded antennas in locations where it is desirable to minimize the visibility of the AP.

*Light grey or clear screw-on cover, low-loss polycarbonate*

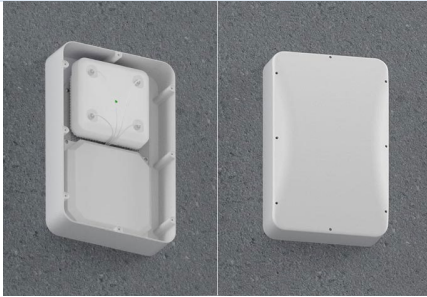

**1021 Series** - Sized for flexibility, this Skybar NEMA-4 enclosure is large enough to conceal and protect APs and directional (panel) antennas.

*White, textured, low-loss polycarbonate*

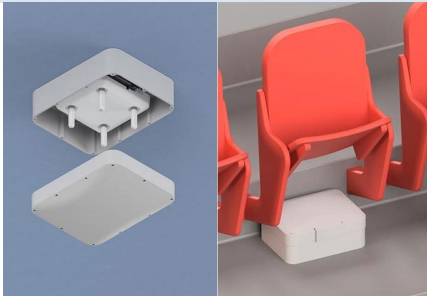

**1022 Series** - The 1022 Skybar NEMA-4 features plenty of room to conceal and protect APs and directly-attached omni-directional antennas.

*White, textured, low-loss polycarbonate*

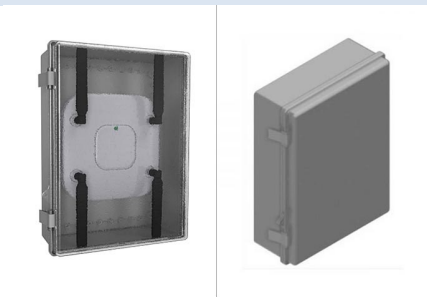

**1024 Series** - This easy-to-install NEMA-4 enclosure features a hinged, lockable lid. Versatile interior mount panel is ideal for all vendors' APs.

*Available with opaque or clear cover*

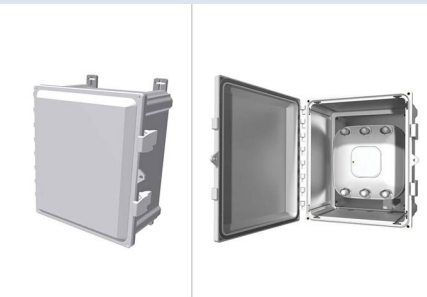

**1026 Series** - These NEMA-4 enclosures feature hinged grey opaque or clear, lockable lids. Versatile interior mount panel is ideal for all vendors' APs.

*Available in many sizes up to 24" x 24"*



**Model 3032** - Oberon's NetPoint Wi-Fi Bollard extends wireless coverage into outdoor areas. These bollards are 60" tall and are large enough to conceal and protect APs, antennas, cables, power injectors and media converters.

*Available in a wide variety of colors*



## Deploying Wi-Fi Infrastructure in Healthcare Environments

Oberon offers a Wi-Fi access point enclosure or mounting solution for virtually every healthcare environment and venue. Oberon's products can help the wireless designer address standards and code compliance, ICRA procedure simplification, and performance and aesthetic challenges in hospitals. Please visit [www.oberoninc.com](http://www.oberoninc.com) for more information.

### 1. HEALTHCARE SPECIAL: BICSI MEDICAL GRADE WIRELESS UTILITY SUPPLEMENTAL INFORMATION

BICSI is a professional association supporting the advancement of the information and communications technology (ICT) community. Identifying a need to provide wireless designers with guidance on providing a wireless utility in hospitals, The BICSI International Standards Wireless Subcommittee created the BICSI Medical Grade Wireless Utility Supplemental Information document. This document defines Medical Grade Wireless Utility (MGWU) in hospitals. MGWU is built upon the premise of three grades of service: Medical, Enterprise and Consumer.



- Medical Grade—LIFE CRITICAL Medical Grade Services support clinical devices and applications that exist to collect and share life critical medical information with providers of medical care.
- Enterprise Grade—MISSION CRITICAL Enterprise grade services support health devices and applications that collect medical information and are intended to “inform and direct.” They are considered mission critical but not life critical.
- Consumer Grade—INFORM Generally for use by the public, Consumer Grade wireless service supports consumer devices and applications that make no medical claim and are meant to “inform.”