

## Rack airflow optimisation

By Patrick Timmer

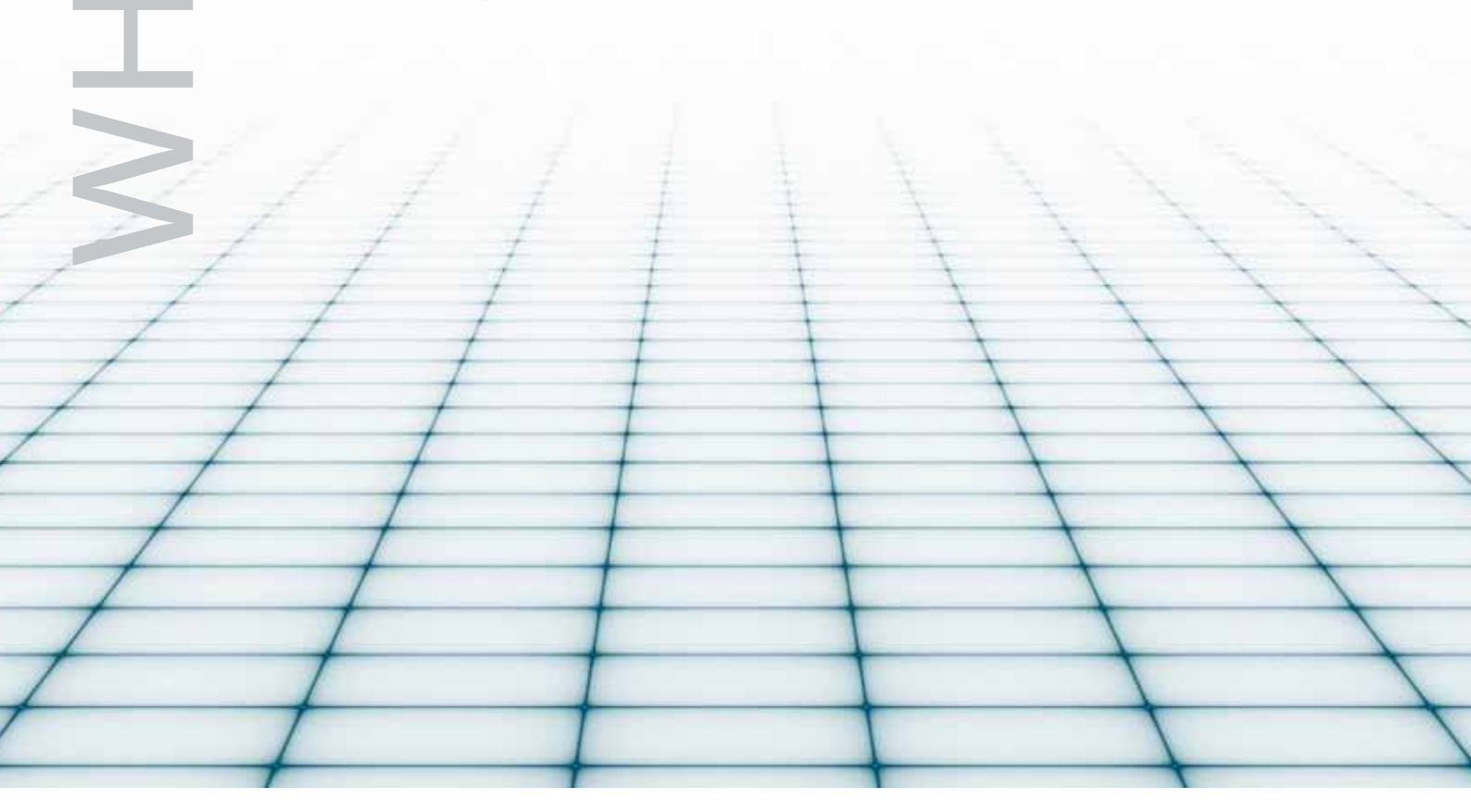



## I: Summary:

Today's Data Centres have become progressively more efficient. New insights and developments in the field of power electronics and cooling have driven down the energy consumption. Data Centre owners with low PUE numbers need to be increasingly more creative to further improve the energy efficiency. What methods can we employ to achieve this? Far too often the simple measures are overlooked, forgotten or assumed common knowledge. It is clear despite the use of energy efficient cooling solutions there is still considerable potential for further improvements to be made. Air bypass and recirculation is such a topic that is easily overlooked or taken for granted. This paper shows that re-inventing some of the most primary assets of the Data Centre, namely the rack and its 19" accessories, still pays off.

The Cold Corridor® was launched in 2006 by Minkels and provided an efficient solution to prevent the large scale mixing of hot and cold air. Despite the improvements, daily practices have revealed that in many situations temperatures inside corridors are not maintained constant enough. A large temperature difference between the air leaving the cooling equipment and entering the IT-equipment has persisted. This could only be the result of hot and cold air mixing. Tuning the cooling units sometimes only made things worse. This stability issue combined with advancing demands on improving energy efficiency have been the main drivers for taking a closer look at the airflows inside Data Centres and specifically within the 19" racks.

A quick first analysis indicated that the locations where air leakage can occur in a traditional raised floor Data Centre are the area around the CRAC, the floor cutouts, and the air bypass and recirculation inside the 19" rack and to a smaller extent the Cold Corridor. In order to identify where major leakages occur a set of air management metrics has been derived and setup in such a way that these inefficiencies in air management can be identified by knowing only the average temperatures at six locations in your Data Centre.

To quantify the air-tightness and get a sense of potential improvements a standard rack of 800 x 1000 x 2200 mm and several 19" accessories have been tested for air-leakage. The results are remarkable and have led to the development of an air-tight server cabinet and 19" accessories. Comparison tests showed that air-tightness in the new cabinet is improved by 86% and the new accessories improve the air-tightness by up to 70%.

By means of calculation example, based on a Case Study, the use of air management metrics is illustrated combined with a savings potential calculation. This shows that a small Data Centre of 100 m<sup>2</sup>, with a heat load of 19,9 kW and an over-dimensioned cooling installation can save € 49 per kW per year by applying the newly designed rack and 19" accessories.

Airflow management is an important factor for a successful Data Centre operation and contributes much to the availability. Air leakage is not a new topic but this paper shows that newly designed cabinets and 19" accessories reduce air-leakage by up to 86%. All in all a big contributor to a reliable and energy efficient Data Centre.





# CONTENTS

Chapter 1: Introduction .....	6
Chapter 2: Airflow Improvement.....	6
Chapter 3: Improved Rack Design .....	9
Chapter 4: Airflow Metrics .....	13
Chapter 5: Case Study .....	16
Chapter 6: Conclusions .....	22
Appendix A: Airflow Metrics Derivation:.....	25

## Chapter 1: Introduction

Today's Data Centre industry is moving more and more towards energy efficient cooling solutions. Free cooling or Fresh Air cooling is one of the techniques which has become increasingly common. This is a great development towards a more sustainable and profitable IT-industry, but there is still much to be gained, especially in the area of proper airflow design. Daily practice shows that despite some useful measures, such as the Cold Corridor, blanking panels etc. there are still a lot of inefficiencies in the air transport system. Due to bypass and recirculation a poor utilization of installed cooling capacity of the air leads to unstable and unpredictable airflow behaviour. This paper shows how air-optimised rack and 19" accessories improve airflow delivery at the right location, that is the server, network and storage equipment. By simple and low-cost improvements major energy consumption and reliability benefits can be achieved.

Although cooling systems become more efficient that doesn't mean cooled air is used optimally. It's like driving a hybrid car over a sandy road. It doesn't make sense if you don't look at all the aspects impacting the efficiency of your cooling design. The air optimising approach is part of Minkels' efforts to create an Operationally Excellent Data Centre. The goal is to better utilize our installed cooling capacity and make sure that all the air leaving the cooling units reach the IT-equipment without any blending along the way. The benefits are a reduced energy consumption, increased cooling capacity and a more manageable environment.

Chapter 2 first identifies the common origin of the air losses and how they can be improved with existing solutions. In Chapter 3 the test results of an airflow improved rack and 19" accessories are presented. To help identify where the airflow inefficiencies in your Data Centre occur Chapter 4 provides useful air management metrics that give a quick scan. Additionally Chapter 5 gives an example, by means of a Case Study, on how these metrics are applied in practice. Chapter 6 concludes this whitepaper.

## Chapter 2: Airflow improvements

Improper airflow design will basically cause the supply (cold) air to warm up and the return air to cool down therefore compromising the efficiency of the cooling system. As a result it makes it hard to predict how much air and at what temperature will make it to the IT-equipment. Although the Cold Corridor has already contributed significantly to minimize these effects there is still room for improvement. The most common causes of non optimal usage of airflow inside a traditional CRAC cooling setup are described below: (see also Figure 1)

1. Static Pressure Difference (SPD): At floor level near the cooling units hot return air can bypass the cooling unit due to differences in air velocities and the resulting static pressure differences, also called negative pressure. The location is typically near the cooling unit due to the high airspeed differences there.
2. Bypass Cold Corridor (BP<sub>CC</sub>): Referring to conditioned air from the raised floor that is directly bypassing the Cold Corridor. Usually this is caused by floor cutouts or poorly sealed cable throughputs on the rear side of cabinets.
3. Bypass Rack (BP<sub>R</sub>): Conditioned air inside the Cold Corridor that is bypassing the IT-

equipment and is directly deposited into the hot corridor. Traditionally this occurs due to poorly sealed side-panels, blanking panels and large gaps between racks, doors and roof panels.

- 4. Recirculation (R): At rack level return air can be forced into the Cold Corridor by poorly designed air ducts around network equipment, fluctuating static pressure build up inside the Cold Corridor and large differences between server's airflow.

The net result of 3 and 4 determine whether the air inside the Cold Corridor heats up or the air deposited in the hot aisle cools down. Air performance metrics provided in Chapter 4 take into account this net effect of the heat transfer.

Figure 1: Air-loss examples

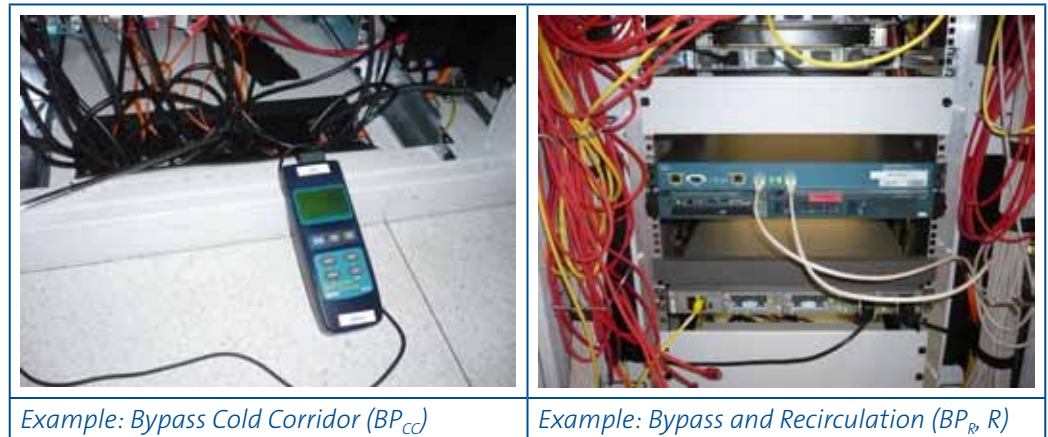

Beside these infrastructure related airflow inefficiencies there can also be building related air losses. Although in some situations they can be significant they fall beyond the scope of this document since they are situation specific.

Figure 2: Types of air-losses.

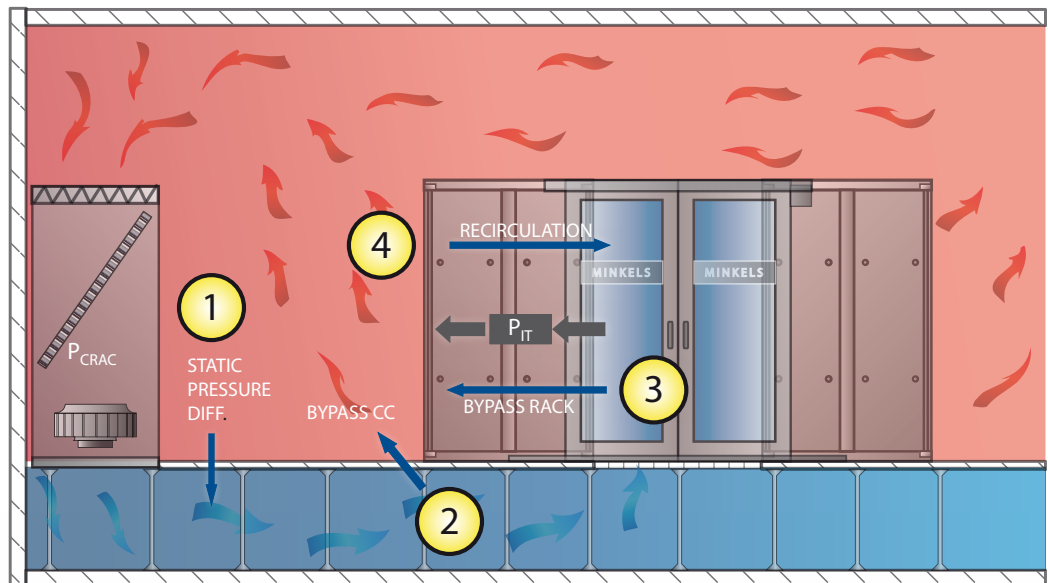

Thankfully in the majority of situations a rack manufacturer can directly improve this

unused cooling capacity by improving its mechanical design and therefore plays a crucial role in optimising the airflow design.

### Existing Improvements:

Many of the improvements are not complex in nature and might seem obvious. However, common day practice shows that often they are poorly executed. The reasons for that can be numerous. Nevertheless, keep the following guidelines in mind.

1. Static Pressure Difference or Negative Pressure can be dealt with by properly sealing the area around the CRAC units or any other cooling devices. Be critical in the selection of floor tiles as well. The biggest gain can come from reducing the average airspeed by increasing the raised floor height as much as possible.
2. Make sure that at the bottom of all cabinets the cable throughputs are sealed completely. Standard cable brushes do not provide sufficient sealing. Improved products exist. Chapter 3 will show some solutions.
3. Use special sealed side panels and blank panels and be critical to all remaining construction related openings. Chapter 3 will show some solutions.
4. Use specially designed network equipment air guidance ducts. Standard solutions do almost never fully force the air in the right direction. An example of a special rack for network equipment is shown in figure 3. Due to the variety of network equipment many special products have been developed already.

*Figure 3: Special rack for Cisco equipment*



5. At server level check the specifications of the servers to be applied. Make sure that your servers contain fans with almost identical fan characteristics. If you do have several type of servers, which is very likely, make sure they are grouped logically. When this is beyond your scope of influence make sure that guidelines are in place.
6. Apply only Cold Corridors where special attention has been paid to air leakage. Prop-



erly sealed roof panels, sliding doors and a door closing system that automatically shuts down are some of the measures which decrease air leakage. Make sure that pressures inside the Cold Corridor do not exceed 5-7 Pa. If you require higher levels of pressure there is something wrong in the way your corridors are setup.

7. Make sure that all openings in the building's wall, that are not meant for natural ventilation, are sealed properly, especially around cable throughputs.

The above mentioned measures require only small additional costs while the benefits are huge. Ranging from improved energy efficiency ratio's, increased cooling capacity and above all more stable conditions inside the corridor and therefore an improved reliability. Chapter 5 shows the airflow improvements related to newly designed rack- and 19" based products.

## Chapter 3: Improved rack design

Initial research into causes of inefficient air usage has indicated, as Chapter 5 will also demonstrate, that 19" cabinets are a logical component to start optimising airflow performance. It is especially near the IT-equipment that bypass and recirculation effects are considerable. Existing cabinets, despite the numerous measures, like blank panels, cable brushes still posses undesirable openings that can cause air bypassing and recirculation. Often our intuition on air tightness lets us down. For example, cable brushes seem airtight but measurements tell us otherwise. Figure 5 below shows an airspeed measurement of 3 m/s locally through a cable brush. This is not only a waste of cooled air but can also compromise adequate floor pressure.

Figure 4(left): thermal image cabinet floor brushes

Figure 5(right): Measured bypass air Cold Corridor (BP<sub>cc</sub>)

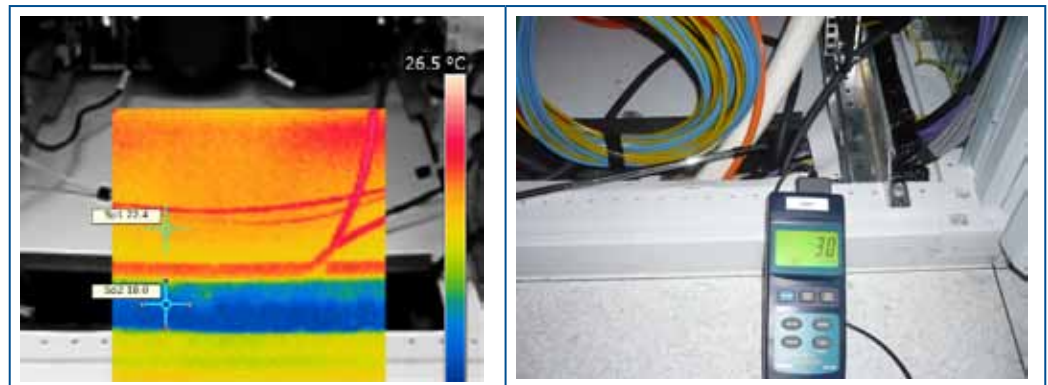

To reduce bypass and recirculation effects, Minkels has developed a special server cabinet and 19" accessories. The improvements range from some small adjustments to completely redesigned accessories. The big question is, what can be gained, technically and financially by using optimised racks and accessories? To find an answer to this question both existing products and newly developed products have been subjected to accurate airflow measurements. This chapter presents the technical solutions and measurement results.

### 3.1 Product improvements:

The origin of many openings in existing 19" cabinets has developed historically to meet a wide range of applications and give the product a high level of flexibility. Simply removing all the gaps would mean a certain loss of functionality, flexibility and ease of use. Also the standards do not support the airtightness of cabinets. The IEC 60297-3 states that any 19" device should have a height of (number HE\*44,45)-0,8 plus a tolerance of 0,4 mm. The allowed tolerance can therefore vary between 0,4-1,2 mm and contains gaps. Another challenge involves dealing with perception about air loss. A visual closure does not always involve a true sealing. Conducting flow pressure measurements is the only way to detect losses. The efforts of a redesign have resulted in the following solutions:

Figure 6: Improvements cabinet and 19" accessories

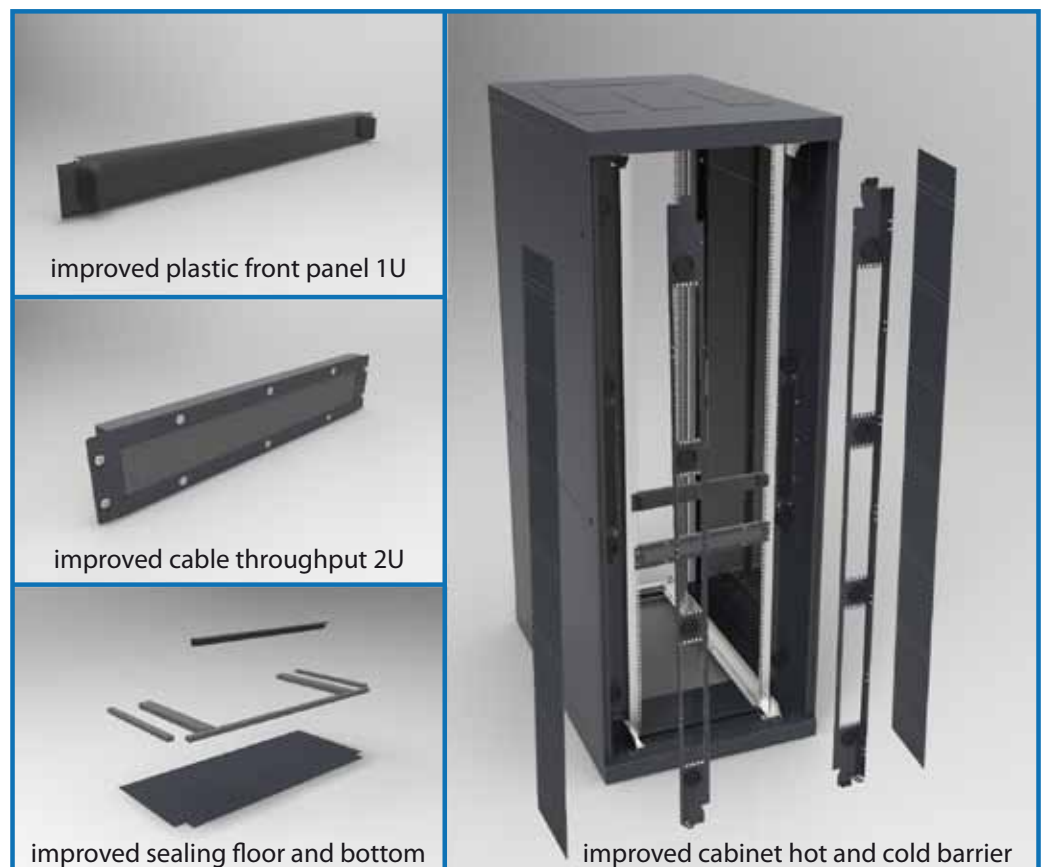

### 3.2 Measurement results

The true benefits of the new solutions can only be quantified when measured and compared to existing solutions. Manual calculations towards airflow resistance of small holes can be quite tricky and inaccuracy easily accumulates with the number of assumptions. CFD, on the other hand, only make sense if boundary conditions can be well defined and true behaviour modelled correctly. Therefore measuring airflow vs. pressure drop has been

selected as the primary source of evaluating the new designs.

**Air leakage at component level:**

At first a series of standard and improved 19" accessories are tested and compared.

Figure 7: Test setup airflow loss accessories.



Figure 8: Airflow losses accessories

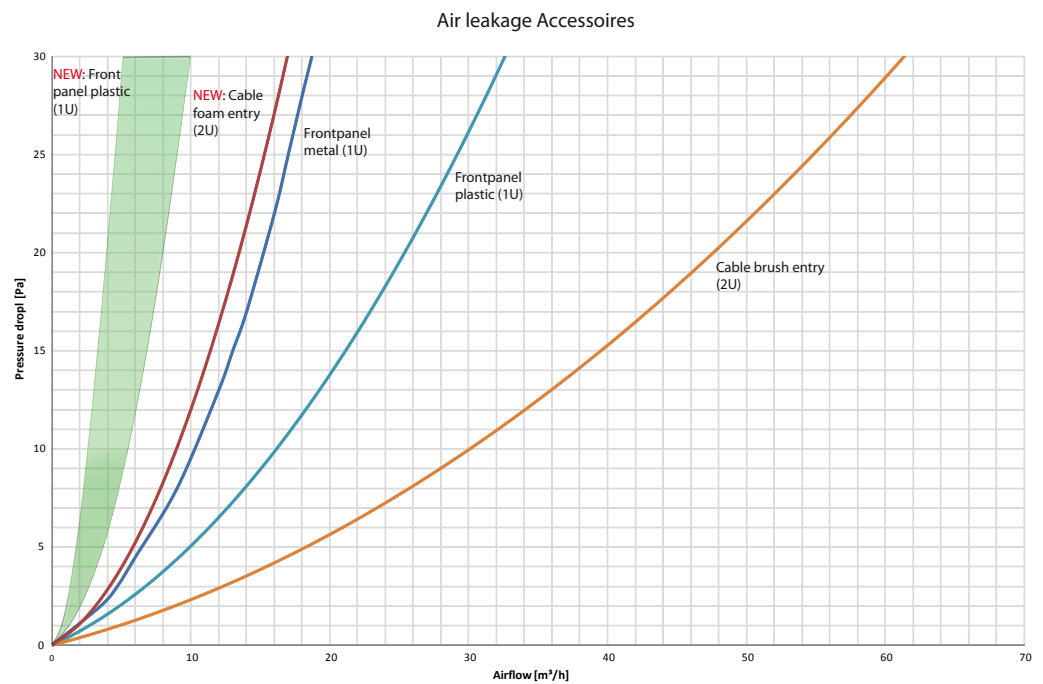

The results indicate that at an 5 Pa pressure difference between cold corridor and hot aisle, the following improvements are achieved:

- 70% air loss reduction for the newly designed plastic front panel.
- 67% air loss reduction for the foam based cable entry against its brush counterpart.

Furthermore the results show that the foam cable entry of 2U even out performs the metal front plate of 1U.

### Air leakage at cabinet level:

Apart from all the accessories which are placed within the 19" space or in the side panels, the cabinet itself also has several small openings which to some extent contribute to air losses. A comparison has been made to an original 800x1000x2200 mm rack design and an optimised one. The results are depicted below:

Figure 9: Airflow losses  
Optimised Cabinet

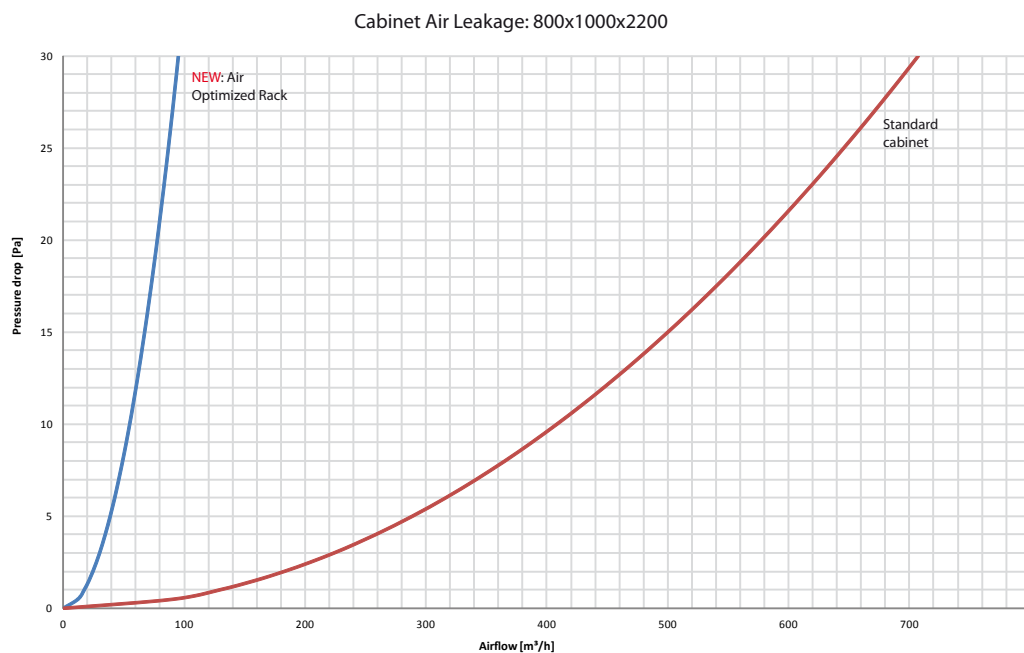

The new improved racks shows a considerable improvement. When it is assumed that inside a cold corridor there exists a differential pressure of 5 Pa towards the hot corridor the improved rack reduces the air losses by 86% per rack. This is truly remarkable.

One can imagine that the leakage ratios will naturally be larger in situations where there is a minimal occupancy of 19" space. Average air speeds are low and therefore the resistance coefficient of each gap or hole is minimal. This is usually the case in start up situations or in low density environments. Air-tightness in Data Centres with a gradual filling of racks with IT-equipment is very crucial.

### 3.3 Benefits

The technical benefits of these improved air-tight products do not limit themselves only by an improved utilization of the cooled air. As a result of this improved utilization, less air needs to be pumped around. Thereby saving on fan energy. As a result the smaller amount of air heats up more and the return air temperature to the cooling units is raised. This not only improves the efficiency of the cooling unit but also allows to raise the overall temperature levels. This provides savings on compressor hours.

The financial benefits will differ among the several cooling solutions. In order to calculate the financial benefits one has to know the cooling system's efficiency under the several cooling loads. It would not make sense here to create a general rule of thumb to estimate the financial benefits. However the Case Study in Chapter 5 reveals that this particular Data Centre could save € 49 per kW per year by applying the air-tight products.

## Chapter 4: Airflow metrics

It can be quite hard to predict how air is flowing around in your Data Centre due to the variances of the obstacles inside it. At some locations you can feel air movement while at other locations the air seems to stand still or even flows back to an undesired location. Different servers with different heat loads and airflow capacities create irregular airflow patterns and combined with cabinet related disturbances and poorly managed cabling strategies this complexity is increased. To be able to tackle this complexity it's important to look at the airflow issue from a coarse perspective. The paragraph presents a set of metrics that help to understand the airflow behaviour and indicates what improvements pay off most.

### 4.1 Airflow metrics:

The airflow metrics can help to identify the major causes of an inefficient air delivery system. Figure 10 shows the dominant type of losses combined with their boundary conditions in a traditional cooling infrastructure. The dashed lines represent the areas where the temperatures are assumed equal. These boundaries are defined to derive the metrics. For those interested a detailed description on the derivation of these metrics can be found in Appendix A. The yellow dots in figure 10 represent the locations where the average temperatures should be collected. Here, only six locations are of specific interest.

Figure 10: Minimal required temperature measurements

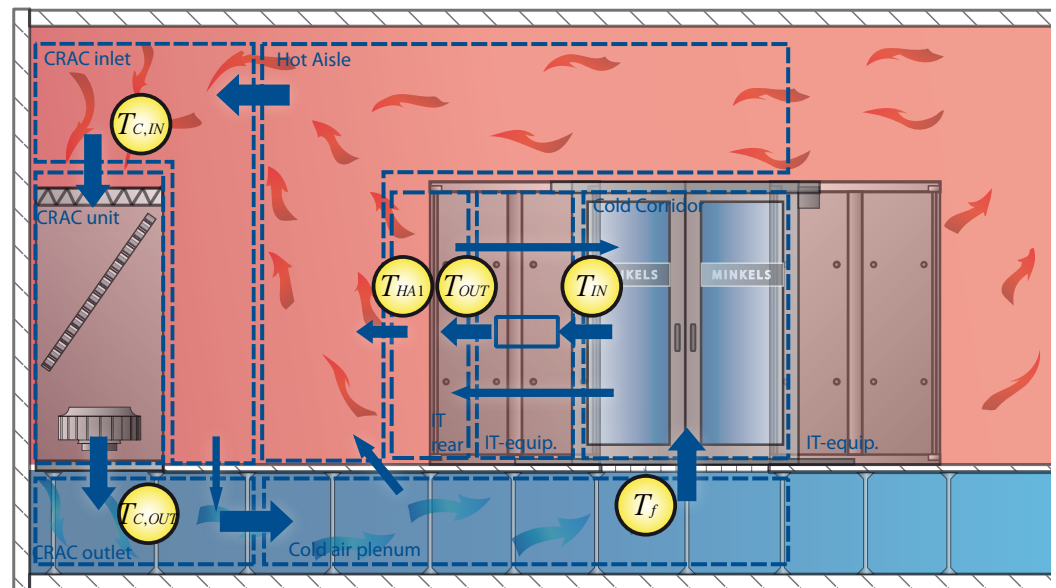

Combined with the set of boundary conditions it is stated that energy and mass are preserved at any time. In this case it is assumed that the amount of cooling capacity equals the amount of heat generated by the IT equipment and other infrastructure devices like UPS's. There is no energy/heat leaving the room through conduction or convection and the main transport of energy is forced convection, which are the fans pushing around the air. With regard to mass it is assumed that there is no air exchange with the outdoor environment and that all mass is preserved within the building. Although natural ventilation is always present, the resulting mixing temperatures often depend on the outdoor climate. For the purpose of this metric this is not taken into account.

Based on the assumptions combined with the chosen boundary conditions the following metrics are derived (see Appendix A for a full derivation):

The following metrics apply

$$\eta_{CRAC} = \frac{\dot{m}_c}{\dot{m}_f} = \frac{(T_{C,IN} - T_f)}{(T_{C,IN} - T_{C,OUT})}; SPD = 1 - \eta_{CRAC}$$

$$\eta_{floor} = \frac{\dot{m}_{CC}}{\dot{m}_f} = \frac{(T_{C,IN} - T_f)}{(T_{OUT} - T_f)}; BP_{CC} = 1 - \eta_{floor}$$

$$\eta_{CC} = \frac{\dot{m}_{CC}}{\dot{m}_{IT}} = \frac{(T_{OUT} - T_{IN})}{(T_{OUT} - T_f)}; R = 1 - \eta_{CC}$$

Where:

$\eta_{CRAC}$ ; is a measure of how well the CRAC unit is able to deliver air in the raised floor

$\eta_{floor}$ ; is a measure of how well the floor is able to deliver air in the Cold Corridor

$\eta_{CC}$ ; is a measure of how well the Cold Corridor is able to deliver the air to the IT equipment

**SPD**: Static Pressure Difference: Airflow caused by pressure differences

**BP<sub>CC</sub>**: Air bypassing the Cold Corridor

**R**: Recirculation airflow

The total air-efficiency is the product of the individual efficiencies according to:

$$\eta_{total} = \eta_{CRAC} \cdot \eta_{floor} \cdot \eta_{CC}$$

The metrics are applicable to many cooling solutions. In some setups there may be additional losses that need to be taken into account, take for example Air Handling Units with long duct systems. In some situations there are less sources for air-leakage. Take for example in-row cooling situations, where there is no perimeter cooling unit and usually no raised floor.

## 4.2 Guidelines for measuring:

To be able to use the metrics one needs to measure temperatures at specific locations, see figure 10:

- $T_{C,IN}$  and  $T_{C,OUT}$  are the average temperature data as close as possible to the individual CRAC's inlet and outlet temperatures.
- $T_{IN}$  and  $T_{OUT}$  are the average temperature data as close as possible to the IT-equipment inlet and outlet temperatures. So within the cabinet's directly before and after the inlet and outlet grilles.
- $T_f$  is the temperature of raised floor air just before it is entering the Cold Corridor.
- $T_{HA1}$  this is basically the area in close proximity of the rear of a cabinet. Typically consistent with the location of the rear door.

Based on the temperature data the metrics can be filled in. To calculate the individual airflow losses one needs at least the airflow through the IT-equipment and through the CRAC units. Finally pressure measurements are required to derive the actual losses in terms of  $m^3/h$ .

The most accurate result in determining total server airflow can be obtained by measuring the power going to each device combined with the temperature difference of that device. The general formula for heat capacity allows for calculating the airflow per device. Summing the individual airflows gives the most accurate result for total IT-airflow. The same holds true for obtaining the CRAC airflow. Once these two numbers are known the metrics can be filled in and the air losses can be calculated. Chapter 4 gives an example by means of a case study.

If power monitoring equipment is not installed there are other ways in obtaining power measurements. For more information on how to measure power, see whitepaper 03 'Tips and Tricks for the professional use of PUE as a management tool'.

## Chapter 5: Case study

Table 1: Data Centre properties

In order to give an example how to apply the metrics in practice and calculate the savings a small corporate Data Centre is measured and evaluated based on the previous proposed method. A short review of the Data Centre at hand is given:

General Information	Value
Total (actual) heat load (IT+UPS)	19,9 kW (15,9+4)
Total Facility-load	27,5 kW (calculated)
Whitespace	103 m <sup>2</sup>
Number of racks	18
Cooling Architecture	CRAC + Raised Floor + Cold Corridors
Number of Corridors	3 corridors of each 6 racks.
Average U utilization per rack	10 U
Installed cooling capacity	65 kW redundant (2N)

### Floor map

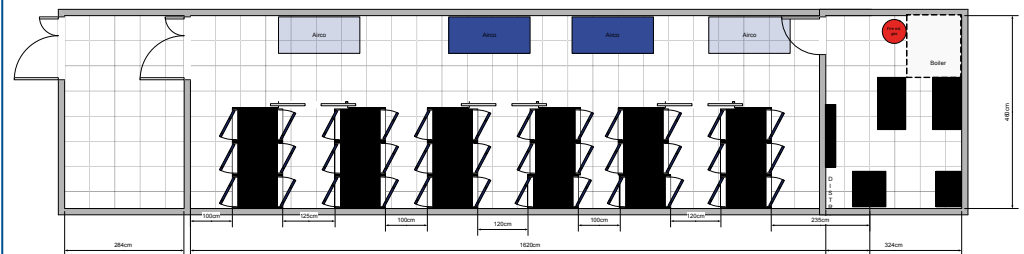

### Images



When looking at the installed equipment one already gets a sense of the possible outcome. Although racks, at delivery, are provided completely with blanking panels, brushes and some other measures to seal cabinets, the reality is that over time a lot of those products tend to disappear. The result is a Cold Corridor that has a lot of areas where cold air can bypass or hot air can recirculate.

### 5.1 Results:

Metered power strips, A and B, are installed per rack and allow for an easy readout of the power consumption. The temperatures of the IT-equipment are collected manually using a hot-wire anemometer and measured at three heights in front and rear of each cabinet and as close as possible to the IT-equipment's inlet and outlet to improve accuracy. The total airflow was calculated as the sum of all the individual IT-servers and UPS's equipment airflows (heat capacity formula:  $P = \dot{m}c_p dT$ ). The air management metrics are applied to the measured data. The results are as follows



Table 2: Measured data and applied metrics

Averaged Measured Values	Value
CRAC supply temp. ( $T_{C,OUT}$ )	16,3 °C
CRAC return temp. ( $T_{C,IN}$ )	24,2 °C
IT supply temp. ( $T_{IN}$ )	22,2 °C
IT return temp. ( $T_{OUT}$ )	24,5 °C
Hot Aisle temp. ( $T_{HA1}$ )	24,4 °C
Raised floor temp. ( $T_f$ ) (directly under tile)	18,4°C
Total airflow (IT+UPS)	25.802 m <sup>3</sup> /h
Pressure diff. Cold Corridor vs. Hot Aisle	1-2 Pa. (average)
Airflow Metrics	Value
$\eta_{CRAC}$	0,73 (ideal=1)
$\eta_{floor}$	0,95 (ideal=1)
$\eta_{CC}$	0,38 (ideal=1)
$SPD=(1-\eta_{CRAC})$	0,27 (ideal=0)
$BP_{CC}=(1-\eta_{floor})$	0,05 (ideal=0)
$R=(1-\eta_{CC})$	0,62 (ideal=0)
CRAC airflow	7512 m <sup>3</sup> /h
Bypass CC airflow	503 m <sup>3</sup> /h
Static Pressure Diff. airflow	2720 m <sup>3</sup> /h
Recirculation airflow	16.073 m <sup>3</sup> /h

Figure 11: Non-compensated airflow calculation

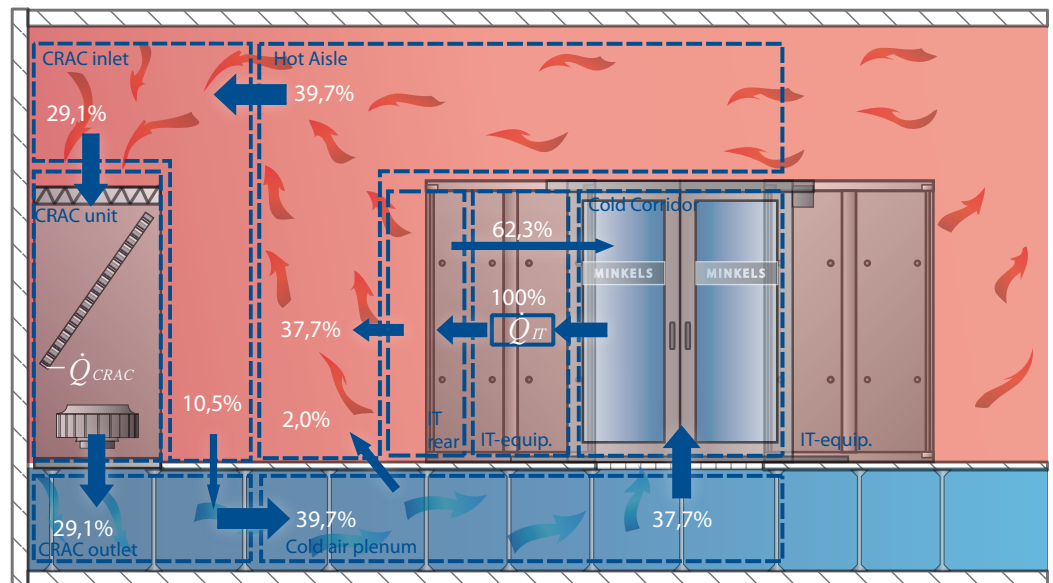

## 5.2 Interpretation results:

At first glance, the derived airflows at the several locations seem doubtful. To get a better understanding what actually takes place in the room the behaviour of the cooling system needs to be taken into account as well. This results in the following findings:

1. To start with, the airflow related to the SPD (Static Pressure difference) of 2720 m<sup>3</sup>/h, can never be that high. When looking at the cooling behaviour of the CRAC unit, it appears that due to the low utilization the compressor is constantly switching ON and OFF. At the moment the compressor is OFF and the fans keep running, hot return air is directly forced under the raised floor and therefore mixing with the previously delivered cold air. Additionally this dynamic cooling behaviour creates measurement errors since one is not able to measure everything at one instance. To improve the quality of the calculation, the SPD is neglected and added to the CRAC airflow. This results in  $m_c = m_f$  and  $T_{c,out} = T_f$ .
2. Another remarkable value is the total amount of airflow through the IT-equipment, that is 25.802 m<sup>3</sup>/h. This seems a bit too much in relation to the type of equipment installed. It's likely that the IT-return temperatures were not measured as close as needed to the rear of the IT-equipment. Already a mixture of bypass air and return air is measured. Based on the mix of equipment installed, network, old IT-equipment and a few blade systems, it is fair to assume that an average standard server airflow of 426 m<sup>3</sup>/h per kW ( $dT=7^{\circ}C$ ) is more likely. This would represent a total IT+UPS airflow of around 8478 m<sup>3</sup>/h. Consequently this means that  $T_{OUT}$  is in fact higher and that the measured temperature  $T_{HA1}$  is in fact more similar to  $T_{CIN}$  since it contains already some  $BP_{CC}$  (Cold Corridor bypass) air. Shifting everything up implies that  $BP_{CC}$  is in reality also bigger. This is consistent with the detected air losses through the cable throughputs in the tiles (see figure 3). Compensating the calculations with a higher  $T_{OUT} = T_{IN} + 7$  K (server outlet temp.) will improve realism.
3. Another detected error that compromises the airflow effectiveness is a standby CRAC unit which is there to meet redundancy levels. At the same time this standby unit serves as a direct channel for delivering cold supply air to the hot aisle. Another factor that indicates that the  $BP_{CC}$  should be higher than it is now.

Applying the above mentioned corrections and reapplying them to the metrics results in the following:

Figure 12: Compensated airflow calculation

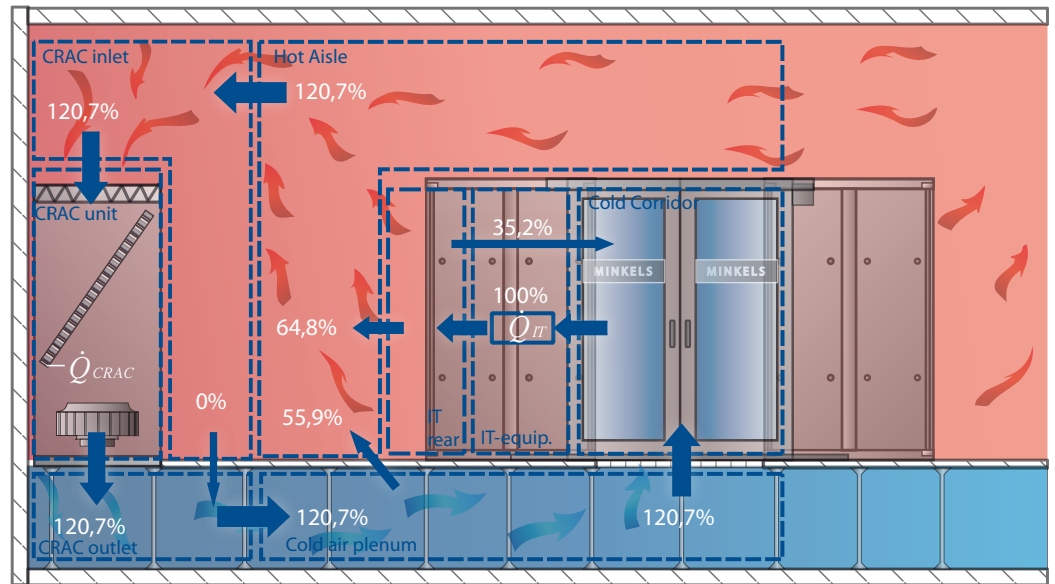

Table 3: Measured data and improved metrics

Airflow Metrics	Value
$\eta_{CRAC}$	1,00 (ideal=1)
$\eta_{floor}$	0,54 (ideal=1)
$\eta_{CC}$	0,65 (ideal=1)
$SPD=(1-\eta_{CRAC})$	0 (ideal=0)
$BP_{CC}=(1-\eta_{floor})$	0,46 (ideal=0)
$R=(1-\eta_{CC})$	0,35 (ideal=0)
IT + UPS airflow	8478 m <sup>3</sup> /h
CRAC airflow	7512 m <sup>3</sup> /h
Bypass CC airflow	4737 m <sup>3</sup> /h
Static Pressure Diff. airflow	0 m <sup>3</sup> /h
Recirculation airflow	2983 m <sup>3</sup> /h

The total efficiency of the cooling system is as follows:

$$\eta_{total} = \eta_{CRAC} \cdot \eta_{floor} \cdot \eta_{CC} = 1,00 \cdot 0,54 \cdot 0,65 = 0,35 \text{ (ideal = 1)}$$

The total amount of airflow that is not optimally used is 4737+2983=7720 m<sup>3</sup>/h. The average leakage per cabinet is 429 m<sup>3</sup>/h at a static pressure of around 1-2 Pa. As one can see is that they are all directly related to the cabinet and therefore improvements at cabinet level will pay off most.

### 5.3 Energy savings:

To give an idea on the energy savings that are possible a reference is created based on the newly air optimised server rack and 19"accessories (see figure 6, chapter 3). Table 4 shows the calculation made under the assumption off a static pressure difference of 5 Pa for the Cold Corridor to the Hot Aisle. This pressure level is chosen since an improved sealing com-

bined with minimal running CRAC increases the pressure build up in the corridor.

Table 4: Reduction airloss by improved rack + accessories

Component	Airloss
Serverrack <b>NEW</b> (18x)	720 m <sup>3</sup> /h
Sliding door (3x)	210 m <sup>3</sup> /h (estimated)
30 HE blanking panels <b>NEW</b> per rack (18x)	1620 m <sup>3</sup> /h
6, 2u sidepanels <b>NEW</b> (18x)	648 m <sup>3</sup> /h
Gaps between servers	270 m <sup>3</sup> /h (estimated)
Total air Loss Optimised	3468 m <sup>3</sup> /h
Original total air loss (R+BP <sub>CC</sub> )	7720 m <sup>3</sup> /h
<b>Total air loss improvement</b>	<b>4252 m<sup>3</sup>/h</b>

The reduction of bypass and recirculation air leads to the following new values:

Figure 13: Airflow optimized situation due to air-tight products

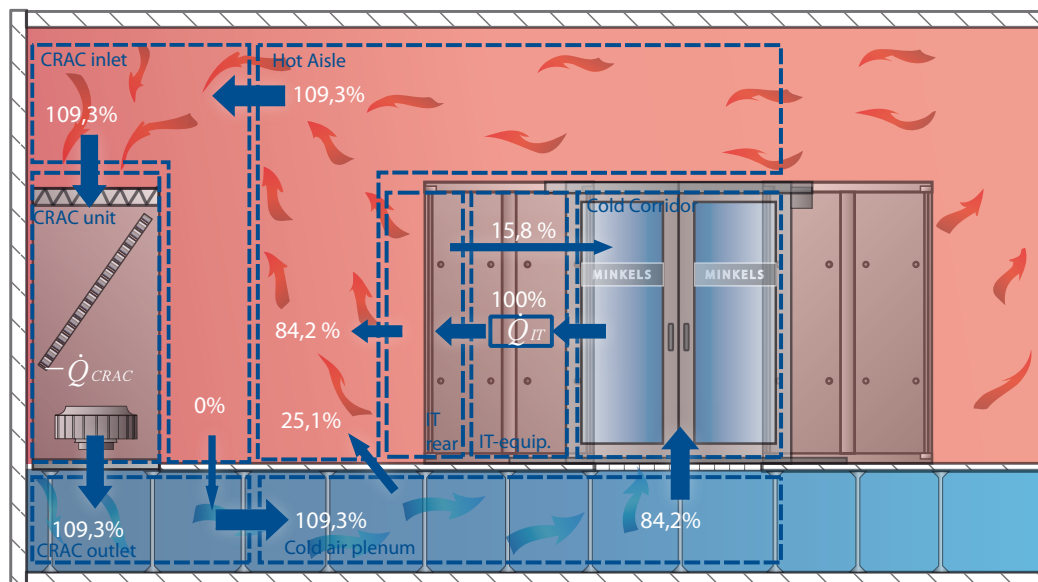

Table 5: Comparison old vs. new situation

Temperature Data	Old values	New values	Temp. Difference
CRAC supply temp. (T <sub>C,OUT</sub> )	16,3 °C	18,4 °C	+ 2,1 K
CRAC return temp. (T <sub>C,IN</sub> )	24,2 °C	24,8 °C	+ 0,6 K
IT supply temp. (T <sub>I,N</sub> )	22,2 °C	19,7 °C	- 2,5 K
IT return temp. (T <sub>O,U,T</sub> )	29,2 °C	26,7 °C	- 2,5 K
Raised floor temp. (T <sub>f</sub> ) (directly under tile)	18,4 °C	18,4 °C	0 K
Airflow Metrics	Old Values	New Values	Improvements %
η <sub>CRAC</sub>	1,00 (ideal=1)	1,00 (ideal=1)	0%
η <sub>floor</sub>	0,54 (ideal=1)	0,77 (ideal=1)	42,6%
η <sub>CC</sub>	0,65 (ideal=1)	0,84 (ideal=1)	29,2%
SPD=(1-η <sub>CRAC</sub> )	0 (ideal=0)	0 (ideal=0)	0%
BP <sub>CC</sub> =(1-η <sub>floor</sub> )	0,46 (ideal=0)	0,23 (ideal=0)	50%

$R=(1-\eta_{CC})$	0,35 (ideal=0)	0,16 0 (ideal=0)	54,3%
IT + UPS airflow	8478 m <sup>3</sup> /h	8478 m <sup>3</sup> /h	0%
CRAC airflow	10.232 m <sup>3</sup> /h	9268 m <sup>3</sup> /h	9,4 %
Bypass CC airflow	4737 m <sup>3</sup> /h	2129 m <sup>3</sup> /h	55,1%
Recirculation airflow	2983 m <sup>3</sup> /h	1339 m <sup>3</sup> /h	55,1%
<b>Total efficiency: <math>\eta_{total}</math></b>	<b>0,351</b>	<b>0,649</b>	<b>85%</b>

The energy savings due to the improved rack design exists at three levels:

1. **Reduction of fan power.** This is a cubic law  $(Q_2/Q_1)^3=(P_2/P_1)$ . An airflow saving of 9,4% leads to a fan power saving of 25,7%. However in most chiller based systems the contribution of fan power is small compared to the compressor power but in this case, due to the low utilization of the compressor the fan power consumption becomes relatively larger. Here it is € 315,-  $(2 \times 0,7=1,4 \text{ kW} * 25,7 \% * 8760 \text{ hrs/y} * € 0,10)$ .
- 2a. **Elevated temperature level:** The reduction of the temperature level with 2,5 K allows for a raise of the complete cooling systems temperature settings. As a retrofit the effectiveness depends very much on the installed system, condenser size, type of refrigerant etc. However for new energy efficient cooling designs, fresh air or direct and indirect free air cooling, an increase of 2,5 K can save up to 962 compressor hours. This leads to the following savings a savings of € 400,-  $(19,9/4,78(\text{COP}) * 962 \text{ hrs} * € 0,10)$ .
- 2b. **Increased delta temperature (dT):** Raised return air temperatures improve the efficiency of almost any cooling device. These savings are product specific. In the type of CRAC unit used here the COP of the compressor improves from 4,46 to 4,78. The savings are € 262,-  $((19,9/4,46)-(19,9/4,78) * 8760 * 0,1)$ .

The total cost saving for this case study, when the cooling infrastructure system would be optimised are € 977,-. This is € 49,- per kW per year.

## 5.4 Conclusions:

Despite measuring inaccuracies and assumptions the fact remains that in this particular case there is a high level of bypass and recirculation air. This Data Centre would benefit greatly by applying the newly designed accessories, providing valves to seal the redundant CRAC unit when in standby and improve the settings of the running CRAC to create smoother ON/OFF patterns. A more modular cooling approach would have been better in this case. An over estimation of IT-capacity is something that occurs quite frequently.

As this example has shown us is that creating accurate values on true air losses is tricky and requires some experience. However using the metrics will provide some sense on the quantities involved and gives direction what improvement might pay-off.

What this case study has shown is that the benefits of using air optimised racks and

accessories significantly improve the effectiveness of the cooled air. A total air efficiency improvement of 85% is considerable and leads to more predictable temperatures for the IT-equipment and is able to save up to €49 per kW per year when the cooling system is completely tuned. Keep in mind, however, that for each specific situation the energy savings will differ. Hopefully this example allows anyone to evaluate this for his/her own situation.

## Chapter 6: Conclusions

One should not only be focused on selecting the most energy efficient cooling solutions. Proper airflow guidance of your cooled air through the Data Centre is just as important as selecting an energy efficient cooling solution. This paper has shown that by optimising server racks and 19" accessories, for airflow leakage, reductions up to 86% are achieved. Since Data Centres require a large amount of air transport to meet the cooling requirements, these savings percentages represent large amounts of air that don't need to be moved. As a result the air behaves more predictably and is delivered where it is needed, that is the IT-equipment. Consequently the heat transport is also more predictable. It is now much easier to guarantee certain temperatures in front of the IT-equipment, allowing to safely raise temperature levels and making energy efficient cooling solutions even more efficient.

To identify where each individual Data Centre can make airflow improvements a range of air management metrics is presented. By applying these metrics one is able to calculate the savings potential and judge whether it's worth the investment. The Case Study shows that these metrics apply well in a real situation but require also some common sense when interpreting the results. In this particular case this Data Centre could save € 49,- per kW/year when equipped with the new racks and 19" accessories.





Apart from the solutions presented in this paper to reduce unwanted airflows, there are a few other suggestions for reducing air leakage. Applying in-row coolers, whether DX or water-based, naturally gets rid of the complete Corridor bypass and CRAC related static pressure differences. The air path between cooler and heat source is minimal. When such solutions are combined with a Cold Corridor and the newly designed racks and accessories, a very stable environment can be achieved. Another suggestion relates to properly housing network equipment. These devices can really mess up a smooth airflow pattern. Minkels already has many variants to house these equipment.

The measurement results reveal that our naked eye is limited in judging on air-losses. Even our hand sensory system fails us when air-speeds are low. Therefore airflow measurements are mandatory to tell us whether a product is truly air tight. This notion drives us to continue our efforts in air optimising our products even further and contribute to a reliable and cost effective Data Centre operation.

**Tips:**

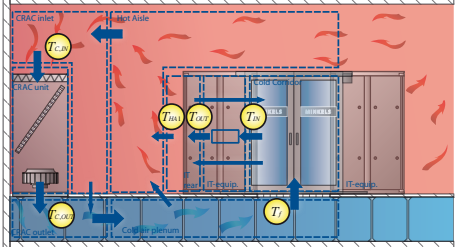
In order to optimize airflow in your Data Centre execute the following

Table 6: Tips for improving airflow efficiency

<p>1. Install metered PDU's, temperature sensors and pressure sensors</p>	
<p>2. Measure the individual temperatures at the given location per cabinet. Only measure where there is true air movement.</p>	
<p>3. Calculate the individual airflow and sum the airflow from the IT-equipment. Do the same for the Cooling Units.</p>	
<p>4. Apply air management metrics to quantify and locate air-losses.</p>	$\eta_{CRAC} = \frac{\dot{m}_c}{\dot{m}_f} = \frac{(T_{c,IN} - T_f)}{(T_{c,IN} - T_{c,OUT})}; SPD = 1 - \eta_{CRAC}$ $\eta_{floor} = \frac{\dot{m}_{CC}}{\dot{m}_f} = \frac{(T_{c,IN} - T_f)}{(T_{OUT} - T_f)}; BP_{CC} = 1 - \eta_{floor}$ $\eta_{CC} = \frac{\dot{m}_{CC}}{\dot{m}_{IT}} = \frac{(T_{OUT} - T_{IN})}{(T_{OUT} - T_f)}; R = 1 - \eta_{CC}$
<p>5. Apply air optimised server racks (or adoptions) and 19"accessories to improve Cold Corridor® functioning.</p>	
<p>6. Use dedicated housings for network equipment to prevent awkward airflow patterns. Minkels already has a wide range of solutions.</p>	
<p>7. In-row solutions gets rid of cooling related and floor related bypass and recirculation airflows and improves airflow efficiency.</p>	

8. Chimney racks create an extra barrier for bypass and recirculation air



9. Cabling from above prevents floor sealing difficulties.



10. Use DCIM software to automate the above mentioned process for identifying locations of air-loss.





## Appendix A: Air management metrics

The goal of the metrics is to find some efficiency number that tells us how much cooled/conditioned air deposited by the CRAC finally makes it to the inlet of the IT-equipment. The complexity of the model is at such a level that practical metrics can be derived. In order to find a set of balanced equations the following assumptions\* are made:

1. All incoming energy is equivalent to the electrical energy to all equipment and all leaving energy is equivalent to the cooling capacity.
2. All mass (airflow) is contained within the room, so no ventilation
3. There is no heat entering or leaving other then through the IT and Cooling-equipment.
4. The complete hot aisle is divided in three parts. An area near the CRAC inlet, an area directly behind the IT-equipment (IT-rear) and area in-between the two.

\*These assumptions might not be appropriate in situations where other heat or cooling sources play a significant role in the total energy balance. So, some care should be taken in applying these formulas.

The boundary conditions are set according to the figure below:

Figure A1: Boundary conditions airflow metrics

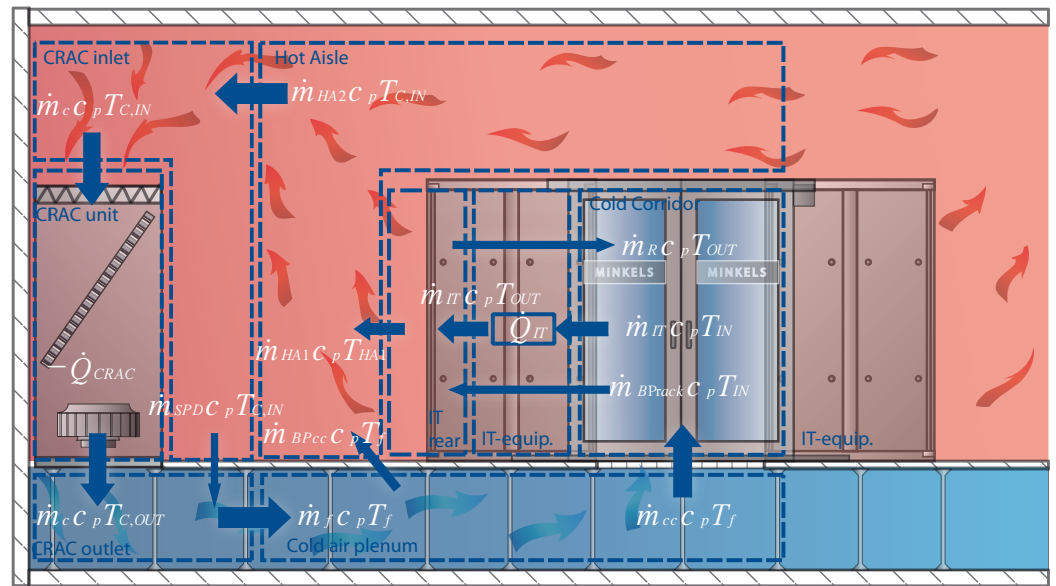

Based on the boundary conditions illustrated in figure A1 the following schematic representation is used to derive the formulas:

Figure A2: Schematic model airflow metrics

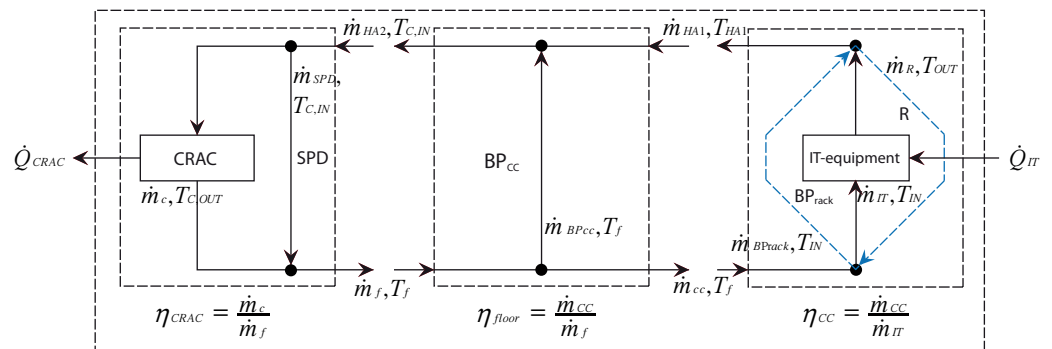

Notice that in the right boundary both the rack bypass ( $BP_{RACK}$ ) and the rack recirculation ( $R$ ) are depicted. Naturally the net result is either bypass or recirculation since they are both travelling between the same nodes. The reason for having both illustrated is to be able to also use the metrics also in the case where the net result is bypass air. In some situations with high static pressures in the Cold Corridor this is possible. The metrics presented for both situations are presented here:

Using the energy and mass equilibrium equations per boundary and per node results in the following metrics: where for the situation of prevailing recirculation around the IT-equipment it is assumed that  $T_{HA1} = T_{OUT}$ :

When recirculation is prevailing:  $T_{IN} > T_f$

$$\eta_{CRAC} = \frac{\dot{m}_c}{\dot{m}_f} = \frac{(T_{C,IN} - T_f)}{(T_{C,IN} - T_{C,OUT})}; SPD = 1 - \eta_{CRAC}$$

$$\eta_{floor} = \frac{\dot{m}_{CC}}{\dot{m}_f} = \frac{(T_{C,IN} - T_f)}{(T_{OUT} - T_f)}; BP_{CC} = 1 - \eta_{floor}$$

$$\eta_{CC} = \frac{\dot{m}_{CC}}{\dot{m}_{IT}} = \frac{(T_{OUT} - T_{IN})}{(T_{OUT} - T_f)}; R = 1 - \eta_{CC}$$

Where:

$\eta_{CRAC}$ ; is a measure of how well the CRAC unit is able to deliver air in the raised floor

$\eta_{floor}$ ; is a measure of how well the floor is able to deliver air in the Cold Corridor

$\eta_{CC}$ ; is a measure of how well the Cold Corridor is able to deliver the air to the IT equipment

$SPD$ : Static Pressure Difference: Airflow caused by pressure differences

$BP_{CC}$ : Air bypassing the Cold Corridor

$R$ : Recirculation airflow

The total efficiency can be regarded as:

$$\eta_{total} = \eta_{CRAC} \cdot \eta_{floor} \cdot \eta_{CC}$$

The difference between  $T_{out}$  and  $T_{HA1}$  is that  $T_{OUT}$  is the actual temperature coming out the IT-server and  $T_{HA1}$  is the temperature after possible mixture of air bypassing around the IT-server. When the bypass air is the prevailing loss around the server the metrics are as follows:

*When bypass at rack level is prevailing:  $T_{IN} \approx T_f$ :*

$$\eta_{CRAC} = \frac{\dot{m}_c}{\dot{m}_f} = \frac{(T_{C,IN} - T_f)}{(T_{C,IN} - T_{C,OUT})}; SPD = 1 - \eta_{CRAC}$$

$$\eta_{floor} = \frac{\dot{m}_{CC}}{\dot{m}_f} = \frac{(T_{C,IN} - T_f)}{(T_{HA1} - T_f)}; BP_{CC} = 1 - \eta_{floor}$$

$$\eta_{CC} = \frac{\dot{m}_{CC}}{\dot{m}_{IT}} = \frac{(T_{OUT} - T_{IN})}{(T_{HA1} - T_f)}; R = 1 - \eta_{CC}$$

$\eta_{CRAC}$ ; is a measure of how well the CRAC unit is able to deliver air in the raised floor

$\eta_{floor}$ ; is a measure of how well the floor is able to deliver air in the Cold Corridor

$\eta_{CC}$ ; is a measure of how well the Cold Corridor is able to deliver the air to the IT equipment

