

Adjustable Cable Runway

Creates a flexible point-to-point pathway for network cabling in data centers, entrance rooms, distribution areas (MDA, HDA), telecommunications rooms and other spaces where cabling enters or exits the pathway.

KEY FEATURES

- Features movable Cross Members for ultimate cable pathway customization
- Supports cable and fiber from floors, ceilings, walls and the tops of cabinets and racks
- Simplifies moves, adds and changes
- Supports tool-less accessories for quick and easy deployment
- Complements other CPI Runway Systems
- Adapts to any data center or computer room
- Ships assembled or unassembled
- Bonded construction

ADVANTAGES

- ➔ **Pathway Dividers**
Divide runway into multiple pathways.

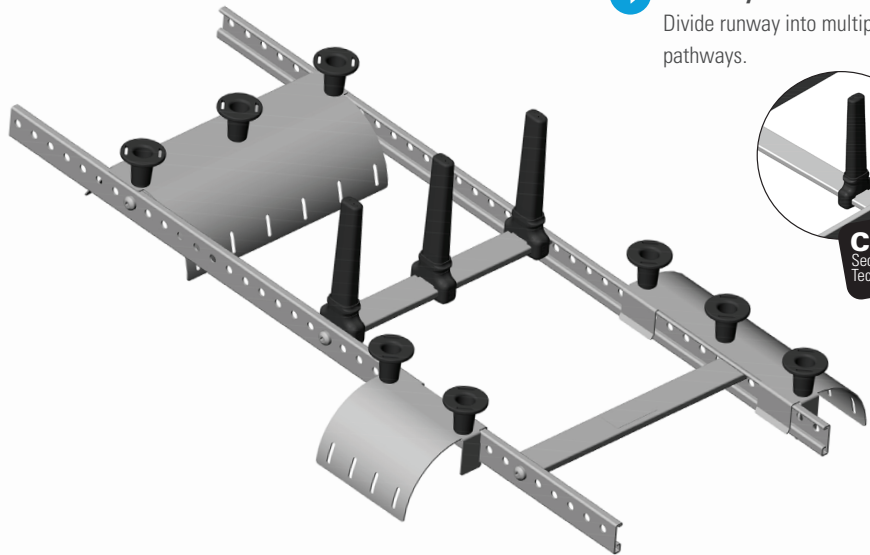

- ➔ **Improved, Tool-less Cable Management Accessories**
Radius Drops can be added and positioned at any location along the runway.

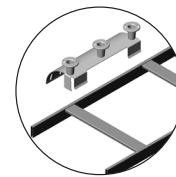

- ➔ **Highly Adaptable**
Cross Members can be repositioned for maximum versatility in aligning cable drops.

SPECIFICATIONS

Finish:

Adjustable Cable Runway	Includes roll-formed Stringers with bolted aluminum Cross Members
Maximum Load	132 lb/ft (196 kg/m) when the runway is supported every 5 ft (1.5 m)
Use	For indoor use only, in environmentally controlled areas, not harsh environments
Materials	Stringers: 119.5" (3035 mm) high-strength, low-alloy steel with 1" (25 mm) repeating-hole pattern and rounded corners Cross Members: 0.80" x 1.5" (20.3 mm x 38 mm) extruded aluminum, T-Shaped Cross Members
Assembly Includes	Two Stringers 10 Cross Members 20 M8 x 20, Taptite Thread-Forming Hexobular (TORX) Screws
Cable Capacity	Use CPI's Cable Fill Table to determine your product cabling needs: http://www.chatsworth.com/cablefill
Grounding/Bonding	Thread-forming screws cut through paint to form an electrical bond between Stringers and Cross Members Use with Grounding Strap Kit (PN 14307) to bond sections of Adjustable Cable Runway across splice points for ANSI/TIA-942-A-B compliance.
Finish	Epoxy-polyester hybrid powder coat paint

Availability: US, Canada, Latin America, Europe, Middle East & Africa

US & Canada

+1-800-834-4969
Toronto, Ontario, Canada
+905-850-7770
chatsworth.com
techsupport@chatsworth.com

Latin America

+52-55-5203-7525
Toll Free within Mexico
01-800-01-7592
chatsworth.com.co

Europe

+44-1628-524-834
chatsworthproducts.co.uk

Middle East & Africa

Dubai, UAE
+971-4-2602125
chatsworth.ae

Asia Pacific

+86 21 6880-0266
chatsworth.com.cn



CHATSWORTH
PRODUCTS

DIMENSIONS

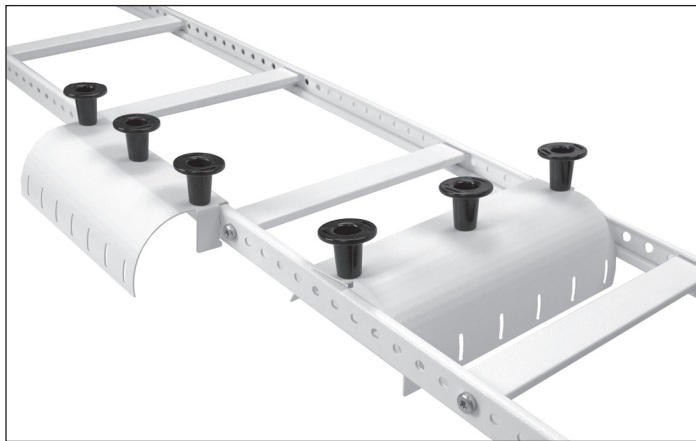
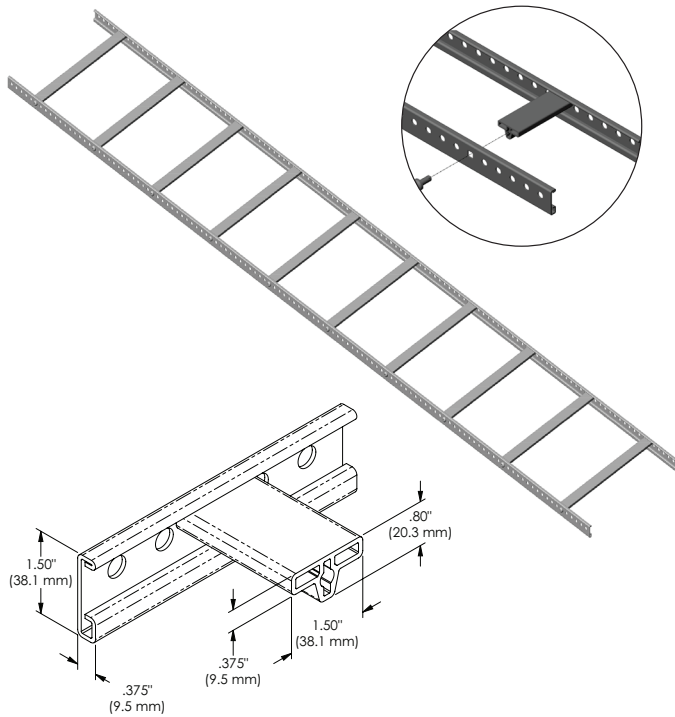

USE WITH

- Universal Cable Runway
- TELCO-Style Cable Runway
- UL Classified Cable Runway
- CPI Rack Systems
- CPI Cabinet and Enclosure Systems
- CPI Grounding and Bonding Products

RELATED PRODUCTS

- Touch-Up Paint in Spray Can
- Touch-Up Paint in Bottle

Design Features

Chatsworth Products (CPI) Adjustable Cable Runway is designed to provide a flexible point-to-point solution anywhere cables enter or exit the cable pathway. The Adjustable Cable Runway features unique, movable Cross Members, which allow components and accessories to be installed at various points along the runway—a feature that simplifies the alignment of cabling above racks, cabinets and cable managers.

Ease of Deployment

Adjustable Cable Runway Cross Members are attached to Runway Stringers at 12" (305 mm) intervals by two thread-forming screws, which once loosened, allow the Cross Member to slide easily across Stringers. Cross Members may be added, removed or adjusted throughout the lifetime of the data center, and the high-load bearing capacity of the runway is maintained when Cross Members stay within 4" (102 mm) of their original mounting points. The Adjustable Cable Runway is compatible with other CPI Runway products and may be joined with Runway Accessories to create turns and transitions to avoid obstacles and provide an organized pathway for cables around the facility.

Adjustable Cable Runway allows facilities to meet ANSI, TIA and EIA installation standards for copper and fiber cabling, while promoting proper bend radii, helping to preserve data transmission integrity and prevent signal degradation. In addition, the Adjustable Cable Runway was designed with insight into key Grounding and Bonding practices, and the runway's thread-forming screws cut through paint in order to create an electrical bond between Cross Members and Stringers.

Convenient and Compatible

The cost-effective Adjustable Cable Runway includes time and labor saving features and accessories. Tool-less Cross Member Radius Drops and Tool-less Stringer Radius Drops have been developed to install without tools or hardware. In addition, the Tool-less Cable Pathway Divider features CPI's Click Secure Technology and attaches to the product clicking into the locked position, assuring technicians that the accessory is securely fastened. These accessories have been developed for reverse compatibility with CPI's Universal (10250), TELCO (11252) and UL Classified (11275) runway, making the Adjustable Cable Runway and tool-less accessories an excellent solution to any challenging cabling environment.

The Adjustable Cable Runway ships assembled or unassembled, requiring less space for inventory storage. Ordering information is listed on the following pages. Contact CPI Technical Support for assistance with configurations.

ORDERING INFORMATION

Part Number	Adjustable Cable Runway 1.5"H x 119.5"L (38 mm x 3035 mm) - Assembled Width - in (mm)	Shipping Weight lb (kg)
14300-X04	4 (102)	17 (8)
14300-X06	6 (152)	18 (8)
14300-X09	9 (229)	19 (8)
14300-X12	12 (305)	20 (9)
14300-X15	15 (381)	21 (10)
14300-X18	18 (457)	22 (10)
14300-X24	24 (610)	25 (11)
14300-X30	30 (762)	27 (12)
14300-X36	36 (914)	30 (13)

Notes: X=Color: 1=Gray, 2=Computer Beige, 7=Black, E=Glacier White

ACCESSORIES

PATENT PENDING



Tool-less Pathway Dividers

CPI's patent-pending Tool-less Pathway Dividers divide cable runway into multiple pathways to organize cables by media type or destination—a solution that enables technicians to better manage moves, adds and changes. Hinged design opens up to wrap around cross members and features CPI's Click Secure Technology.

- Compatible with all styles of CPI Runway
- Manufactured from polycarbonate/acrylonitrile butadiene styrene (PC/ABS) material
- UL 94-V0 flammability rating for optimum impact and heat resistance
- Sold in packs of 10 and 100
- Finish: Black

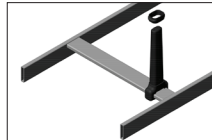
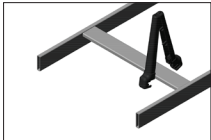

When you hear the click you know it's secure.

PATENT PENDING

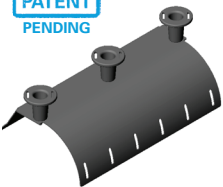

Tool-less Cross Member Radius Drop

CPI's patent-pending Tool-less Cross Member Radius Drop supports and guides cable loads as they enter and exit the runway, allowing cables to maintain proper bend radius. The Tool-less Cross Member Radius Drop is designed for compatibility with 1.5" x 3/8" (38 mm x 9.53 mm) Stringers and installs without the need for tools, mounting directly to the sides of the runway.

- Tool-less Cross Member Radius Drops may be positioned over or between the Runway Cross Members
- Use Saf-T-Grips or cable ties, along with the tie-down slots to fully deploy the cable support solutions
- Provides 3" (76.2 mm) bend radius
- Includes 1.4"H (36 mm), 1" (25 mm) diameter ABS cable spools to separate and guide cables
- Compatible with Universal, TELCO, UL Classified and Adjustable Cable Runway
- Sold individually
- Manufactured from steel; spools are plastic
- For appropriate fit, match Cross Member Radius Drop width to runway width

PATENT PENDING



Tool-less Stringer Radius Drop

CPI's patent-pending Tool-less Stringer Radius Drop features simple, tool-less installation.

- Use Saf-T-Grips or cable ties along with the tie-down slots to fully deploy the cable support solutions.
- Provides 3" (76.2 mm) bend radius
- Supplied with 1.4"H (36 mm), 1" (25 mm) diameter, ABS cable spools to separate and guide cables
- Unique design slips over the Runway Stringers and clamps in position; fits Runway Stringers that are 1-1/2"H x 3/8"W (38 mm x 9.53 mm)
- Compatible with Universal, TELCO, UL Classified and Adjustable Cable Runway
- Sold individually

Grounding Strap Kit

The Grounding Strap Kit provides a grounded pathway between runway lengths. Ground straps consist of an 8"L (200 mm) #6-7 AWG stranded insulated copper conductor and are attached to a two-hole compression lug with 5/16" bolt holes at both ends. Bolt holes are spaced on 1" (25 mm) centers to match hole-to-hole spacing on Adjustable Cable Runway Stringers.

- 1" (25 mm) centers
- An overall length of 10.8" (273 mm)
- UL Listed components

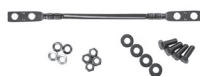

Ground Strap installed.

Adjustable Cable Runway Accessories		
Part Number	Description in (mm)	Shipping Weight lb (kg)
14308-001	Tool-less Pathway Dividers, 6"H (152), Pack of 10	2 (1.0)
14308-002	Tool-less Pathway Dividers, 6"H (152), Pack of 100	15 (7.0)
14304-X04	Tool-less Cross Member Radius Drop, 4"W (102), 2 Spools	2 (1.0)
14304-X06	Tool-less Cross Member Radius Drop, 6"W (152), 2 Spools	2 (1.0)
14304-X09	Tool-less Cross Member Radius Drop, 9"W (229), 2 Spools	2 (1.0)
14304-X12	Tool-less Cross Member Radius Drop, 12"W (305), 3 Spools	3 (1.0)
14304-X15	Tool-less Cross Member Radius Drop, 15"W (381), 3 Spools	3 (1.0)
14304-X18	Tool-less Cross Member Radius Drop, 18"W (457), 3 Spools	4 (2.0)
14304-X24	Tool-less Cross Member Radius Drop, 24"W (610), 3 Spools	6 (3.0)
14304-X30	Tool-less Cross Member Radius Drop, 30"W (762), 3 Spools	7 (3.0)
14304-X36	Tool-less Cross Member Radius Drop, 36"W (914), 5 Spools	7 (3.0)
14305-X00	Tool-less Stringer Radius Drop, Large, 10.5 (268), 3 Spools	3 (1.0)
14305-X01	Tool-less Stringer Radius Drop, Small, 5.5 (140), 2 Spools	2 (1.0)
14302-X04	Cross Member Kit, 4"W (102), Pack of 10	4 (2.0)
14302-X54	Cross Member Kit, 4"W (102), Pack of 50	36 (16.0)
14302-X06	Cross Member Kit, 6"W (152), Pack of 10	4 (2.0)
14302-X56	Cross Member Kit, 6"W (152), Pack of 50	44 (20.0)
14302X09	Cross Member Kit, 9"W (229), Pack of 10	6 (3.0)
14302-X59	Cross Member Kit, 9"W (229), Pack of 50	56 (25.0)
14302-X12	Cross Member Kit, 12"W (305), Pack of 10	6 (3.0)
14302-X62	Cross Member Kit, 12"W (305), Pack of 50	60 (27.0)
14302-X15	Cross Member Kit, 15"W (381), Pack of 10	7 (3.0)
14302-X65	Cross Member Kit, 15"W (381), Pack of 50	68 (31.0)
14302-X18	Cross Member Kit, 18"W (457), Pack of 10	8 (4.0)
14302-X68	Cross Member Kit, 18"W (457), Pack of 50	80 (36.0)
14302-X24	Cross Member Kit, 24"W (610), Pack of 10	9 (4.0)
14302-X74	Cross Member Kit, 24"W (610), Pack of 50	92 (42.0)
14302-X30	Cross Member Kit, 30"W (762), Pack of 10	12 (5.0)
14302-X36	Cross Member Kit, 36"W (914), Pack of 10	16 (7.0)
14303-X10	Stringer Kit, 1.5"H x 0.4"W x 119.5"L (38 mm x 10 mm x 3035 mm), Pack of 10	69 (31.0)
14307-001	Grounding Strap Kit, 10.8"L (273), Each	1 (0.5)
14307-025	Grounding Strap Kit, 10.8"L (273), Pack of 25	25 (11.4)

Notes: X=Color: 1=Gray, 2=Computer Beige, 7=Black, E=Glacier White

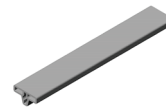
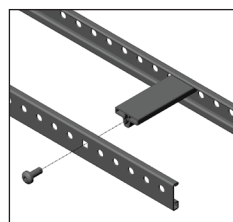

Cross Member Kits and Stringer Kit (Unassembled Adjustable Cable Runway)

Adjustable Cable Runway Stringers and Cross Members are available separately. Accessory kits allow sub-components to be inventoried in compact packages.

- Cross Member Kit - 10 Pack. Use with two Runway Stringers to create one length (stick) of runway
- Cross Member Kit - 50 Pack. Use with 10 Runway Stringers to create five sticks of runway
- Stringer Kit - 10 Pack
- Cross Members are aluminum; Stringers are steel
- Each Cross Member Kit includes (2) M8 x 20, Taptite thread-forming hexalobular (TORX) screws for each Cross Member

ACCESSORIES

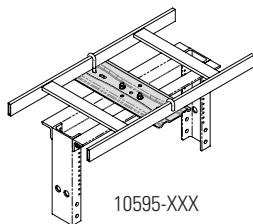
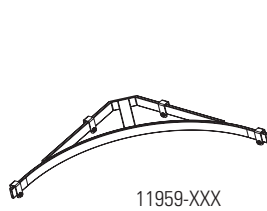
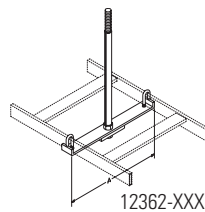
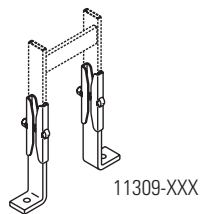
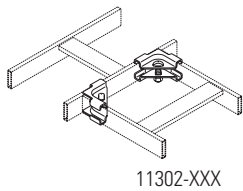
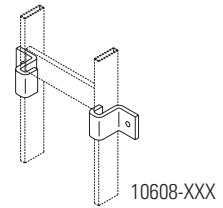
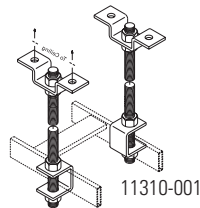
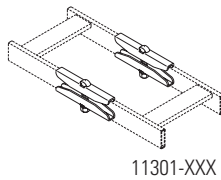
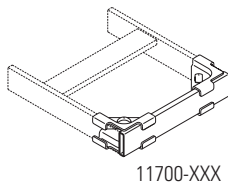
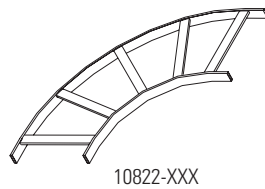
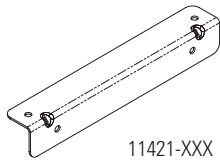
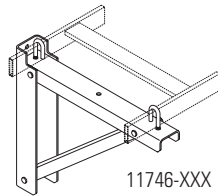
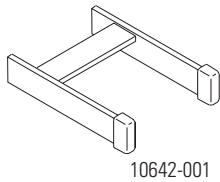
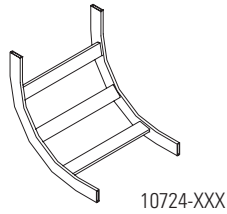
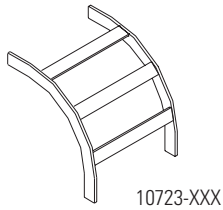

Additional Accessories		
Part Number	Description in (mm)	Shipping Weight lb (kg)
10723-X12*	Radius Bend, 90° Outside Bend, 12"W (305)	2 (1.0)
10724-X12*	Radius Bend, 90° Inside Bend, 12"W (305)	2 (1.0)
10642-001	Protective End Caps	1 (0.5)
11746-X12*	Triangle Support Bracket, 12"W (305)	2 (1.0)
11421-X12*	Wall Angle Support Bracket, 12"W (305)	2 (1.0)
10822-X12*	Cable Runway E-Bends, 12"W (305)	6 (3.0)
11700-X12*	Cable Runway End Closing Kit, 12" (305)	6 (3.0)
11301-001	Butt Splice Kit, 1-1/2" x 3/8" (38.1 mm x 9.53 mm) Stringer, Gold over Zinc	1 (0.5)
11302-001	Junction Splice Kit, 1-1/2" x 3/8" (38.1 mm x 9.53 mm) Stringer, Gold over Zinc	1 (0.5)
11309-X01	Runway Foot Kit	4 (1.8)
11959-X15*	Corner Bracket, 15"W, Angle Dims- 15.48" (393.2)	4 (1.8)
10595-X12*	3" Channel Rack-To-Runway Mounting Plate, Steel	5 (2.3)
11310-001*	Threaded Ceiling Kit, 3/8" (9.53 mm) Rod	3 (1.4)
10608-X01	Vertical Wall Brackets, One Pair	4 (1.8)
12362-X12*	Cable Runway Center Support Kit, 12"W (305)	2 (0.9)

Note: X=color: 0=Gold, 1=Gray, 2=Computer Beige, 7=Black, E=Glacier White.
 *Other sizes available. 11309-XXX, 11959-XXX, 10608 and 12632 not available in Gray.

For product CSI Specs, visit the Support & Downloads page on www.chatsworth.com.



Scan or click here to visit our CPI Online Catalog.