



PRODUCT CATALOGUE

innovatively simple cable
and connectivity solutions

- DATA NETWORKING SOLUTIONS
- AUDIO/VIDEO SOLUTIONS
- PC AND MOBILE SOLUTIONS
- POWER SOLUTIONS
- CUSTOM SOLUTIONS

TABLE OF CONTENTS



DATA/NETWORK SOLUTIONS

Enterprise computing and networking applications demand superior connectivity solutions. C2G has the products and services to support virtually every enterprise connectivity need, from single-mode and multimode fibre patch cables to Cat5e/Cat6 cables and devices.

page

01



AUDIO/VIDEO SOLUTIONS

C2G understands the wide-ranging needs of the audio/video market. Audio/Video Solutions from C2G feature a broad offering of precision-crafted cables and powerful, yet easy-to-use active devices.

page

17



PC & MOBILE SOLUTIONS

C2G has the right accessories to enhance virtually any computer application. We provide a wide range of cables, signal extenders and selectors from USB cables, adapters and hubs—to firewire, parallel and serial cables.

page

43



POWER SOLUTIONS

C2G's power cords make your work environment more flexible and efficient. Our power cords are designed to work with most desktop PCs, laptops, monitors, scanners, and printers, as well as PDUs, PSUs, gaming consoles and audio/video equipment.

page

65



CUSTOM SOLUTIONS

C2G tailors connectivity to fit your needs. Whether you need a simple, modified stock cable alteration or a more complex custom-engineered solution, C2G has the manufacturing experience you can count on.

page

75



C2G History

C2G is a leading manufacturer of IT and A/V connectivity solutions. C2G works to provide its customers with the products, tools and resources to get connected quickly and efficiently.

With around 2,000 products ready to ship through its channel network, C2G can quickly deliver, regardless of how big or small your project is. We only use the finest components and the latest technology to optimise performance and ensure compliance to industry specifications.

C2G is committed to helping partners provide unique products, while delivering unparalleled service and value-added solutions.

Visit us today at www.c2g.com
Great King Street North | Birmingham, West Midlands B19 2LF

Freephone:
(UK) 0800 328 2916
(EMEA) +44 (0)1952 677300

UK Sales Enquiries: UKsales@c2g.com
EMEA Sales Enquiries: EUsales@c2g.com

Distributors & Resellers

C2G products are widely available through distribution. Our close relationships with the industry's top distributors mean many of our products are available within a quick turn around time. All of our packaging is eco friendly to keep costs down, while enabling C2G resellers to customise the final solution. To learn more about the exciting opportunities C2G offers go to www.c2g.com or call our European office at 0800 328 2916 (UK) or +44 (0)1952 677300 (EMEA).

Terms & Conditions

Prices are subject to change without notice. Custom ordered products are non-returnable and cannot be cancelled. Shipping discrepancies must be reported within five days of receipt.

Call our customer service department for more information at: 0800 328 2916 (UK) or +44 (0)1952 677300 (EMEA)

Returns

Any C2G product returns should first be handled through the reseller or distributor from where you originally purchased the product.

Warranty

C2G offers a lifetime guarantee against defects and labour on all cables. Other distributed products such as active devices and computer accessories carry a full, one year warranty against defects. Warranties do not apply to damage from misuse or consequential damage. Our warranty liability will not exceed the purchase price of a product. C2G assumes no liability for damage and/or injury resulting from use of equipment supplied by this company, including, but not limited to, the loss of data or profit.

Live Chat

Receive immediate answers to your questions from one of our cable experts. Click Live Chat from www.c2g.com and within seconds you will be in touch with one of our connectivity experts. Hours of operation are Monday to Friday 8:30am to 22:30pm UK time. After hours, your questions will automatically be emailed to our experts and answered the next business day.

ConnectXpress

C2G's ConnectXpress tool offers thousands of cabling solutions, making it simple and convenient to find a product for your application. Start by going to <http://www.c2g.com/uk/connectxpress>. From there select the connectivity solution category that matches your application or device, then choose your connector, colour, length or other special options and you'll be presented with only the products that meet your needs. If you're not sure what you need, select the device you are trying to connect and discover the device's common connectors. ConnectXpress is available online 24/7 and is your on demand connectivity expert.

Errors & Omissions

From time to time there may be information in our product categories that contains typographical errors, inaccuracies, or omissions that may relate to product descriptions, pricing, and availability. C2G reserves the right to correct any errors, inaccuracies or omissions, and to change or update information at any time without prior notice (including after you have submitted your order).

Note: Apple®, iPod® and iPhone® are registered trademarks of Apple Computer, Inc., registered in the U.S. and other countries. The products in this catalogue are not manufactured or endorsed by Apple Computer Inc.

Vista® and Windows® are registered trademarks of Microsoft® Corporation. The products in this catalogue are not manufactured or endorsed by Microsoft Corporation.

All other third party brands, trademarks, and registered trademarks are the property of their respective owners.

Some of our leading distributors include ...



DATA/
NETWORK
SOLUTIONS



NEW



LEGRAND® BRANDED TRANSCEIVERS NOW AVAILABLE

Meets or exceeds the OEM equivalent specification



Offering transceivers for these OEM brands:



FINISAR®



NETGEAR®

AVAYA
NORTEL

BROCADE®

ARISTA



Our data communications solutions just got bigger with the expansion of our Legrand* branded transceiver line.

- Competitively Priced
- Compatibility Guaranteed
- Lifetime Warranty
- Comply with Multi-Source Agreement (MSA) Standards

*C2G proudly joined Legrand in 2014



89117



89112



89100

ARISTA NETWORKS® COMPATIBLE 1000BASE AND 10GBASE TRANSCEIVERS

SKU	Item Description	Range
89117	Arista Networks SFP-1G-T Compatible 1000Base-TX Copper SFP (mini-GBIC) Transceiver Module	100m
89131	Arista Networks SFP-10G-LR Compatible 10GBase-LR SMF SFP+ Transceiver Module	10km
89096	Arista Networks AR-SFP-10G-SR Compatible 10GBase-SR MMF SFP+ Transceiver Module	300m

BROCADE® COMPATIBLE 1000BASE AND 10GBASE TRANSCEIVERS

SKU	Item Description	Range
89112	Brocade 10G-SFPP-SR Compatible 10GBase-SR MMF SFP+ Transceiver Module	300m
88603	Brocade E1MG-SX-OM Compatible 1000Base-SX MMF SFP (mini-GBIC) Transceiver Module	550m
89125	Brocade E1MG-TX Compatible 1000Base-TX Copper SFP (mini-GBIC) Transceiver Module	100m
89144	Brocade E1MG-LX-OM Compatible 1000Base-LX SMF SFP (mini-GBIC) Transceiver Module	10km

CISCO® COMPATIBLE 10GBASE TRANSCEIVERS

SKU	Item Description	Range
89100	Cisco XFP10GLR-192SR-L Compatible 10GBase-LR SMF XFP Transceiver Module	10km
89104	Cisco X2-10GB-LR Compatible 10GBase-LR SMF X2 Transceiver Module	10km
89128	Cisco SFP-10G-ER Compatible 10GBase-ER SMF SFP+ Transceiver Module	40km
89132	Cisco XENPAK-10GB-SR Compatible 10GBase-SR MMF XENPAK Transceiver Module	300m
89133	Cisco XFP-10G-MM-SR Compatible 10GBase-SR MMF XFP Transceiver Module	300m
89070	Cisco SFP-10G-SR Compatible 10GBase-SR MMF SFP+ Transceiver Module	300m
89071	Cisco SFP-10G-LR Compatible 10GBase-LR SMF SFP+ Transceiver Module	10km
89072	Cisco SFP-10G-LRM Compatible 10GBase-LRM MMF SFP+ Transceiver Module	220m
89073	Cisco X2-10GB-SR Compatible 10GBase-SR MMF X2 Transceiver Module	300m



88601



89116



89123

CISCO® COMPATIBLE 1000BASE TRANSCEIVERS

SKU	Item Description	Range
88601	Cisco GLC-LX-SM-RGD Compatible 1000Base-LX SMF SFP (mini-GBIC) Transceiver Module	10km
89108	Cisco SFP-GE-S Compatible 1000Base-SX MMF SFP (mini-GBIC) Transceiver Module	550m
88602	Cisco SFP-GE-L Compatible 1000Base-LX SMF SFP (mini-GBIC) Transceiver Module	10km
89115	Cisco WS-G5483 Compatible 1000Base-TX Copper GBIC Transceiver Module	100m
89119	Cisco SFP-1GB-SX Compatible 1000Base-SX MMF SFP (mini-GBIC) Transceiver Module	550m
88604	Cisco GLC-EX-SMD Compatible 1000Base-EX SMF SFP (mini-GBIC) Transceiver Module	40km
89138	Cisco WS-G5486 Compatible 1000Base-LX SMF GBIC Transceiver Module	10km
89143	Cisco ONS-SI-GE-SX Compatible 1000Base-SX MMF SFP (mini-GBIC) Transceiver Module	550m
89055	Cisco GLC-T Compatible 1000Base-T Copper SFP (mini-GBIC) Transceiver Module	100m
89058	Cisco GLC-SX-MM Compatible 1000Base-SX MMF SFP (mini-GBIC) Transceiver Module	550m
89061	Cisco GLC-LH-SM Compatible 1000Base-LX SMF SFP (mini-GBIC) Transceiver Module	10km
89064	Cisco GLC-ZX-SM Compatible 1000Base-ZX SMF SFP (mini-GBIC) Transceiver Module	80km
88607	Cisco GLC-SX-MMD Compatible 1000Base-SX MMF SFP (mini-GBIC) Transceiver Module	550m
88608	Cisco GLC-LH-SMD Compatible 1000Base-LX SMF SFP (mini-GBIC) Transceiver Module	10km
88609	Cisco GLC-SX-MM-RGD Compatible 1000Base-SX MMF SFP (mini-GBIC) Transceiver Module	550m
89068	Cisco GLC-BX-U Compatible 1000Base-BX SMF SFP (mini-GBIC) Transceiver Module	10km
89069	Cisco GLC-BX-D Compatible 1000Base-BX SMF SFP (mini-GBIC) Transceiver Module	10km
89074	Cisco WS-G5484 Compatible 1000Base-SX MMF SC GBIC Transceiver Module	550m
88610	Cisco SFP-GE-T Compatible 1000Base-T Copper SFP (mini-GBIC) Transceiver Module	100m

CISCO® COMPATIBLE 2/4/8GBS TRANSCEIVERS

SKU	Item Description	Range
89116	Cisco DS-SFP-FC8G-SW Compatible 2/4/8Gbs Fibre Channel SW MMF SFP+ Transceiver Module	150m

CISCO® COMPATIBLE 100BASE TRANSCEIVERS

SKU	Item Description	Range
89123	Cisco GLC-FE-100LX Compatible 100Base-LX SMF SFP (mini-GBIC) Transceiver Module	10km
88605	Cisco GLC-FE-100FX-RGD Compatible 100Base-FX MMF SFP (mini-GBIC) Transceiver Module	2km
89054	Cisco GLC-GE-100FX Compatible 100Base-FX MMF SFP (mini-GBIC) Transceiver Module	2km
89076	Cisco GLC-FE-100FX Compatible 100Base-FX MMF SFP (mini-GBIC) Transceiver Module	2km



89129



89141



89124



89113



89110

CISCO® COMPATIBLE 40GBASE TRANSCEIVERS

SKU	Item Description	Range
89129	Cisco QSFP-40G-SR4 Compatible 40GBase-SR MMF QSFP+ Transceiver Module	150m

FINISAR® COMPATIBLE 1000BASE TRANSCEIVERS

SKU	Item Description	Range
89141	Finisar FCLF-8521-3 Compatible 1000Base-TX Copper SFP (mini-GBIC) Transceiver Module	100m
89126	Finisar FTLF8519P2BNL Compatible 1000Base-SX MMF SFP (mini-GBIC) Transceiver Module	550m

FINISAR® COMPATIBLE 1/2/4GBS TRANSCEIVERS

SKU	Item Description	Range
89124	Finisar FTLF8524P2BNL Compatible 1/2/4Gbs Fibre Channel SW MMF SFP (mini-GBIC) Transceiver Module	150m
89114	Finisar FTLF8524P2BNV Compatible 1/2/4Gbs Fibre Channel SW MMF SFP (mini-GBIC) Transceiver Module	150m

FINISAR® COMPATIBLE 2/4/8GBS TRANSCEIVERS

SKU	Item Description	Range
89113	Finisar FTLF8528P2BCV Compatible 2/4/8Gbs Fibre Channel SW MMF SFP+ Transceiver Module	300m

FINISAR® COMPATIBLE 10GBASE TRANSCEIVERS

SKU	Item Description	Range
89110	Finisar FTLX1471D3BCL Compatible 10GBase-LR SMF SFP+ Transceiver Module	10km
89102	Finisar FTLX8571D3BCL Compatible 10GBase-SR MMF SFP+ Transceiver Module	300m
89122	Finisar FTLX8571D3BCV Compatible 10GBase-SR MMF SFP+ Transceiver Module	300m



89145



89109



89137



89135

HP® COMPATIBLE 1000BASE TRANSCEIVERS

SKU	Item Description	Range
89145	HP 3CSFP91 Compatible 1000Base-SX MMF SFP (mini-GBIC) Transceiver Module	550m
89142	HP 453154-B21 Compatible 1000Base-TX Copper SFP (mini-GBIC) Transceiver Module	100m
89134	HP J4860C Compatible 1000Base-ZX SMF SFP (mini-GBIC) Transceiver Module	70km
89085	HP J4858C Compatible 1000Base-SX MMF SFP (mini-GBIC) Transceiver Module	550m
89089	HP J4859C Compatible 1000Base-LX SMF SFP (mini-GBIC) Transceiver Module	10km
89087	HP J8177C Compatible 1000Base-TX Copper SFP (mini-GBIC) Transceiver Module	100m
89088	HP JD089B Compatible 1000Base-TX Copper SFP (mini-GBIC) Transceiver Module	100m
89084	HP JD118B Compatible 1000Base-SX MMF SFP (mini-GBIC) Transceiver Module	550m
89090	HP JD119B Compatible 1000Base-LX SMF SFP (mini-GBIC) Transceiver Module	10km
89086	HP JD493A Compatible 1000Base-SX MMF SFP (mini-GBIC) Transceiver Module	550m

HP® COMPATIBLE 10GBASE TRANSCEIVERS

SKU	Item Description	Range
89109	HP 455883-B21 Compatible 10GBase-SR MMF SFP+ Transceiver Module	300m
89091	HP J9150A Compatible 10GBase-SR MMF SFP+ Transceiver Module	300m
89093	HP J9151A Compatible 10GBase-LR SMF SFP+ Transceiver Module	10km
89092	HP JD092B Compatible 10GBase-SR MMF SFP+ Transceiver Module	300m
89094	HP JD094B Compatible 10GBase-LR SMF SFP+ Transceiver Module	10km

HP® COMPATIBLE 2/4/8GBS TRANSCEIVERS

SKU	Item Description	Range
89137	HP AJ716A Compatible 2/4/8Gbs Fibre Channel SW MMF SFP+ Transceiver Module	300m

HP® COMPATIBLE 100BASE TRANSCEIVERS

SKU	Item Description	Range
89135	HP J9054C Compatible 100Base-FX MMF SFP (mini-GBIC) Transceiver Module	2km



JUNIPER NETWORKS® COMPATIBLE 1000BASE TRANSCEIVERS

SKU	Item Description	Range
89103	Juniper Networks EX-SFP-1GE-T Compatible 1000Base-TX Copper SFP (mini-GBIC) Transceiver Module	100m
89081	Juniper Networks EX-SFP-1GE-LX Compatible 1000Base-LX SMF SFP Transceiver Module	10km
89080	Juniper Networks EX-SFP-1GE-SX Compatible 1000Base-SX MMF SFP Transceiver Module	550m
89079	Juniper Networks SFP-1GE-LX Compatible 1000Base-LX SMF SFP (mini-GBIC) Transceiver Module	10km
89078	Juniper Networks SFP-1GE-T Compatible 1000Base-TX Copper SFP (mini-GBIC) Transceiver Module	100m

JUNIPER NETWORKS® COMPATIBLE 10GBASE TRANSCEIVERS

SKU	Item Description	Range
89101	Juniper Networks EX-XFP-10GE-LR Compatible 10GBase-LR SMF XFP Transceiver Module	10km
89120	Juniper Networks XFP-10G-S Compatible 10GBase-SR MMF XFP Transceiver Module	300m
89083	Juniper Networks EX-SFP-10GE-LR Compatible 10GBase-LR SMF SFP+ Transceiver Module	10km
89082	Juniper Networks EX-SFP-10GE-SR Compatible 10GBase-SR MMF SFP+ Transceiver Module	300m

JUNIPER NETWORKS® COMPATIBLE 10/100/1000BASE TRANSCEIVERS

SKU	Item Description	Range
89107	Juniper Networks SFP-1GE-FE-E-T Compatible 10/100/1000Base-TX Copper SFP (mini-GBIC) Transceiver Module	100m

OTHER COMPATIBLE TRANSCEIVERS

SKU	Item Description	Range
89098	3COM® 3CSFP92 Compatible 1000BASE-LX SMF SFP (mini-GBIC) Transceiver Module	10km
89146	Avaya®/Nortel® AA1419013-E5 Compatible 1000Base-SX MMF SFP (mini-GBIC) Transceiver Module	550m
88606	Avaya®/Nortel® AA1419048-E6 Compatible 1000Base-SX MMF SFP (mini-GBIC) Transceiver Module	550m
89140	Enterasys® MGBIC-LC03 Compatible 1000Base-MX MMF SFP (mini-GBIC) Transceiver Module	2km
89121	Extreme Networks® 10301 Compatible 10GBase-SR MMF SFP+ Transceiver Module	300m
89097	Force10® GP-XFP-1S Compatible 10GBase-SR MMF XFP Transceiver Module	300m
89105	Intel® E10GSFSPSR Compatible 10GBase-SR MMF SFP+ Transceiver Module	10km
89099	MSA Compliant 1000Base-SX MMF SFP (mini-GBIC) Transceiver Module	550m
89127	MSA Compliant 1000Base-SX MMF SFP (mini-GBIC) Transceiver Module	550m
89130	MSA Compliant 40GBase-SR MMF QSFP+ Transceiver Module	150m
89095	Netgear® AGM731F Compatible 1000Base-SX MMF SFP (mini-GBIC) Transceiver Module	550m



89926

CAT6A BOOTED SHIELDED (SSTP) NETWORK PATCH CABLE

Protect 10 Gigabit data transmissions from 10GBase-T ports and equipment in high noise environments

This Booted Shielded Cat6a Patch Cable is ideal for use with 10GBase-T ports and equipment, such as network adapters, hubs, switches, routers, DSL/cable modems and patch panels, and will protect a high speed 10 Gigabit network connection from noise and electromagnetic interference. For voice/data/video distribution, this cable will handle bandwidth-intensive applications and drastically reduces both impedance and structural return loss (SRL). Each patch cable is fully tested to meet ANSI/TIA 568 C.2 Cat6a component requirements.

	Grey	Blue	Black	White
0.3m	89921	89926	89931	89933
0.5m	89900	89907	89914	89934
1m	89901	89908	89915	89935
1.5m	89902	89909	89916	89936
2m	89903	89910	89917	89937
3m	89904	89911	89918	89938
5m	89905	89912	89919	89939
7m	89906	89913	89920	89940
10m	89922	89927	89932	89941
15m	89923	89928	—	—
20m	89924	89929	—	—
30m	89925	89930	—	—

83413



83630



83484



CAT6 BOOTED UNSHIELDED (UTP) NETWORK PATCH CABLE

Snagless booted design for network adapters, hubs, switches, routers, DSL/cable modems, patch panels and other high performance networking applications

For Fast Ethernet and Gigabit computer networks that require bandwidth-intensive voice, data, or video distribution applications. Meets all Cat6 TIA/EIA standards, and drastically reduces both impedance and structural return loss (SRL). Each of the individual pairs is bonded together to help maintain the twist-spacing throughout the line, right up to the termination point. Constructed from high quality copper cable, this design minimises Near-End Crosstalk (NEXT) levels. The moulded, snagless boot prevents unwanted cable snags during installation and provides extra strain relief. Available in a variety of colours to easily colour-coded your network installation. Each cable is individually labelled with the length for ease of use.

	Grey	Blue	Black	White	Red	Yellow	Green	Orange	Pink	Purple	Brown
0.3M	83364	83384	83404	83484	—	—	—	—	—	—	—
0.5M	83365	83385	83405	83485	83445	83465	83425	83573	83587	83630	83644
1M	83366	83386	83406	83486	83446	83466	83426	83574	83588	83631	83645
1.5M	83367	83387	83407	83487	83447	83467	83427	83575	83589	83632	83646
2M	83368	83388	83408	83488	83448	83468	83428	83576	83590	83633	83647
3M	83369	83389	83409	83489	83449	83469	83429	83577	83591	83634	83648
5M	83370	83390	83410	83490	83450	83470	83430	83578	83592	83635	83649
7M	83371	83391	83411	83491	83451	83471	83431	83579	83593	83636	83650
10M	83372	83392	83412	83492	83452	83472	83432	83580	83594	83637	83651
15M	83373	83393	83413	83493	—	—	—	—	—	—	—
20M	83374	83394	83414	83494	—	—	—	—	—	—	—
30M	83375	83395	83415	83495	—	—	—	—	—	—	—
50M	83376	83396	—	—	—	—	—	—	—	—	—
100M	83377	83397	—	—	—	—	—	—	—	—	—

CATEGORY CABLES

CAT6 BOOTED UNSHIELDED (UTP) CROSSOVER CABLE

Unparalleled performance for peer-to-peer and crossover applications

Fast, fast, fast—for data/voice/video distribution. This 550MHz-rated patch cable ensures you always have the necessary throughput to handle today's and tomorrow's bandwidth-intensive applications. The crossed pin configuration allows you to connect two computers peer-to-peer without the need for a hub or switch. You can also use the crossover cable to connect network switches and hubs without an uplink port to other switches and hubs.



83505

	Black	Blue	Grey	Red
0.5m	83539	83522	83505	83556
1m	83540	83523	83506	83557
1.5m	83541	82524	82507	83558
2m	83542	83525	83508	83559
3m	83543	83526	82509	83560
5m	83544	83527	83510	83561
7m	83545	83528	83511	83562

CAT5E BOOTED UNSHIELDED (UTP) NETWORK PATCH CABLE

Snagless booted design for network adapters, hubs, switches, routers, DSL/cable modems, patch panels and other high performance networking applications

For Fast Ethernet networks that require bandwidth-intensive voice, data, or video distribution applications. Meets all Cat5e TIA/EIA standards, and drastically reduces both impedance and structural return loss (SRL). Each of the individual pairs are bonded together to help maintain the twist-spacing throughout the line, right up to the termination point. Constructed from high quality copper cable, this design minimises Near-End Crosstalk (NEXT) levels. The moulded, snagless boot prevents unwanted cable snags during installation and provides extra strain relief. Available in a variety of colours to easily colour-code your network installation. Each cable is individually labelled with the length for ease of use.



83602



83672



	Grey	Blue	Black	White	Red	Yellow	Green	Orange	Pink	Purple	Brown
0.3m	83139	83159	83179	83259	—	—	—	—	—	—	—
0.5m	83140	83160	83180	83260	83220	83240	83200	83602	83616	83658	83672
1m	83141	83161	83181	83261	83221	83241	83201	83603	83617	83659	83673
1.5m	83142	83162	83182	83262	83222	83242	83202	83604	83618	83660	83674
2m	83143	83163	83183	83263	83223	83243	83203	83605	83619	83661	83675
3m	83144	83164	83184	83264	83224	83244	83204	83606	83620	83662	83676
5m	83145	83165	83185	83265	83225	83245	83205	83607	83621	83663	83677
7m	83146	83166	83186	83266	83226	83246	83206	83608	83622	83664	83678
10m	83147	83167	83187	83267	83227	83247	83207	83609	83623	83665	83679
15m	83148	83168	83188	83268	—	—	—	—	—	—	—
20m	83149	83169	83189	83269	—	—	—	—	—	—	—
30m	83150	83170	83190	83270	—	—	—	—	—	—	—
50m	83151	83171	—	—	—	—	—	—	—	—	—
100m	83152	83172	—	—	—	—	—	—	—	—	—

CAT5E NON-BOOTED UNSHIELDED (UTP) NETWORK PATCH CABLE

For network adapters, hubs, switches, routers, DSL/cable modems, patch panels and other high performance networking applications

For voice/data/video distribution, this cable will handle bandwidth-intensive applications up to 350MHz. Meets all Cat5e TIA/EIA standards, and drastically reduces both impedance and structural return loss (SRL) when compared to standard 100MHz wire. Each of the individual pairs is bonded together to help maintain the twist-spacing throughout the line, right up to the termination point.



83060

	Grey	Blue	Black	White	Red	Yellow	Green
0.5m	83000	83020	83040	83120	83080	83100	83060
1m	83001	83021	83041	83121	83081	83101	83061
1.5m	83002	83022	83042	83122	83082	83102	83062
2m	83003	83023	83043	83123	83083	83103	83063
3m	83004	83024	83044	83124	83084	83104	83064
5m	83005	83025	83045	83125	83085	83105	83065
7m	83006	83026	83046	83126	83086	83106	83066
10m	83007	83027	83047	83127	83087	83107	83067
15m	83008	83028	83048	83128	—	—	—
20m	83009	83029	83049	83129	—	—	—
30m	83010	83030	83050	83130	—	—	—

CAT5E NON-BOOTED UNSHIELDED (UTP) CROSSOVER CABLE

Use with a network adapter to network two Windows®-based desktop PCs in a peer-to-peer, hub-to-hub, transceiver-to-transceiver or repeater-to-repeater networking configuration

For voice/data/video distribution, this cable will handle bandwidth-intensive applications up to 350MHz. Meets all Cat5e TIA/EIA standards, and drastically reduces both impedance and structural return loss (SRL) when compared to standard 100MHz wire. Each of the individual pairs is bonded together to help maintain the twist-spacing throughout the line, right up to the termination point.



83331

	Grey	Blue	Black	Red	Yellow
0.5m	83280	83297	83314	83331	83348
1m	83281	83298	83315	83332	83349
1.5m	83282	83299	83316	83333	83350
2m	83283	83300	83317	83334	83351
3m	83284	83301	83318	83335	83352
5m	83285	83302	83319	83336	83353
7m	83286	83303	83320	83337	83354

CAT5E NON-BOOTED SHIELDED (STP) NETWORK PATCH CABLE

Protect from EMI/RFI interference; connect network adapters, hubs, switches, routers, DSL/cable modems, patch panels and other networking applications in high noise environments

Protect your high speed network from noise and electromagnetic interference when you connect with our shielded Cat5e patch cable. Meets or exceeds industry standards for NEXT and return loss. The snagless boot provides extra strain relief and durability. Available in a variety of colours to easily colour-code your network installation.



83750

	Grey	Blue	Black	White	Red	Yellow	Green
1m	83750	83770	83850	83880	83790	83810	83830
2m	83751	83771	83851	83881	83791	83811	83831
3m	83752	83772	83852	83882	83792	83812	83832
4m	83753	83773	83853	83883	83793	83813	83833
5m	83754	83774	83854	83884	83794	83814	83834
7m	83755	83775	83855	83885	83795	83815	83835
10m	83761	83781	83860	83886	83800	83821	83840
15m	83756	83776	83856	83887	83796	83816	83836
20m	83757	83777	83857	83888	—	—	—
30m	83758	83778	83858	83889	—	—	—
50m	83759	83779	83859	83890	—	—	—
100m	83760	83780	—	—	—	—	—



62.5/125 OM1 DUPLEX MULTIMODE PVC FIBRE OPTIC CABLE (LSZH) – ORANGE

62.5/125 micron cable for Fast Ethernet, Fibre Channel, ATM and Gigabit Ethernet applications where protection from toxic and corrosive gases is critical

The Low Smoke Zero Halogen (LSZH/LSOH) jacket is composed from materials that lessen the smoke and halogen emissions when the cable is exposed to extreme temperatures. This reduces the amount of harmful toxic and corrosive gases that cabling made with plastic materials would otherwise emit into the air during combustion. This construction makes LSZH cables ideal for use where the protection of people and equipment from harmful corrosive gases is absolutely critical. The patented injection moulding process provides each connection greater durability in resisting pulls, strains and impacts from cabling installs. Each cable is 100% optically inspected and tested for insertion loss before you receive it.



85239

LENGTH	ST-ST	SC-SC	SC-ST	LC-SC	LC-ST	LC-LC
1m	85207	85239	85223	85255	85271	85287
2m	85208	85240	85224	85256	85272	85288
3m	85209	85241	85225	85257	85273	85289
5m	85210	85242	85226	85258	85274	85290
7m	85211	—	—	85259	85275	85291
10m	85212	—	85228	85260	85276	85292
15m	85450	85453	85456	85459	85462	85465
20m	85451	85454	85457	85460	85463	85466
30m	85452	85455	85458	85461	85464	85467

50/125 OM2 DUPLEX MULTIMODE PVC FIBRE OPTIC CABLE (LSZH) – ORANGE

Supports longer distances with lower loss than 62.5/125 fibre for Fast Ethernet, Fibre Channel, ATM and Gigabit Ethernet applications where protection from toxic and corrosive gases is critical

Cost effective solution that provides higher bandwidth and transmission rates and supports longer distances with lower loss than 62.5/125 fibre. Specifically designed for use with today's narrower aperture components, this cable is fully compatible with multimode applications. The Low Smoke Zero Halogen (LSZH/LSOH) jacket is composed from materials that lessen the smoke and halogen emissions when the cable is exposed to extreme temperatures. This reduces the amount of harmful toxic and corrosive gases that cabling made with plastic materials would otherwise emit into the air during combustion. This construction makes LSZH cables ideal for use where the protection of people and equipment from harmful corrosive gases is absolutely critical. The patented injection moulding process provides each connection greater durability in resisting pulls, strains and impacts from cabling installs. Each cable is 100% optically inspected and tested for insertion loss before you receive it.



85319

LENGTH	ST-ST	SC-SC	SC-ST	LC-SC	LC-ST	LC-LC
1m	85468	85303	85480	85319	85492	85335
2m	85469	85304	85481	85320	85493	85336
3m	85470	85305	85482	85321	85494	85337
5m	85471	85306	85483	85322	85495	85338
7m	85472	85307	85484	85323	85496	85339
10m	85473	—	85485	85324	85497	85340
15m	85474	85477	85486	85489	85498	85501
20m	85475	85478	85487	85490	85499	85502
30m	85476	85479	85488	85491	85500	85503

10GB 50/125 OM3 DUPLEX MULTIMODE PVC FIBRE OPTIC CABLE (LSZH) – AQUA

LSZH-rated fibre optic cable designed for 10GBase-SR and 10GBase-LRM ports and equipment

This OM3 Duplex Multimode Fibre Optic Cable is ideal for connecting 10GBase-SR, 10GBase-LRM, SFP+ and QSFP+ transceivers for 10 gigabit network connections. This cable has a LSZH jacket which protects from toxic and corrosive gases in poorly ventilated spaces and other areas where it is most critical. This cable also provides backward compatibility with existing 50/125 equipment and the performance headroom required to support LED and VCSEL laser light sources, and 10 Gigabit Ethernet applications. The Low Smoke Zero Halogen (LSZH/LSOH) jacket is composed from materials that lessen the smoke and halogen emissions when the cable is exposed to extreme temperatures.

85531



LENGTH	ST-ST	SC-SC	SC-ST	LC-SC	LC-ST	LC-LC
1m	85504	85513	85522	85531	85540	85549
2m	85505	85514	85523	85532	85541	85550
3m	85506	85515	85524	85533	85542	85551
5m	85507	85516	85525	85534	85543	85552
7m	85508	85517	85526	85535	85544	85553
10m	85509	85518	85527	85536	85545	85554
15m	85510	85519	85528	85537	85546	85555
20m	85511	85520	85529	85538	85547	85556
30m	85512	85521	85530	85539	85548	85557
50m	—	—	—	—	—	85558

9/125 OS1 DUPLEX SINGLE-MODE PVC FIBRE OPTIC CABLE (LSZH) – YELLOW

9/125 micron cable for Gigabit Ethernet applications where protection from toxic and corrosive gases is critical

The Low Smoke Zero Halogen (LSZH/LSOH) jacket is composed from materials that lessen the smoke and halogen emissions when the cable is exposed to extreme temperatures. This reduces the amount of harmful toxic and corrosive gases that cabling made with plastic materials would otherwise emit into the air during combustion. This construction makes LSZH cables ideal for use where the protection of people and equipment from harmful corrosive gases is absolutely critical. The patented injection moulding process provides each connection greater durability in resisting pulls, strains and impacts from cabling installs. Each cable is 100% optically inspected and tested for insertion loss before you receive it. A pull-proof jacket design surrounds the popular 9/125 single-mode fibre, immune to electrical interference.

85559



LENGTH	ST-ST	SC-SC	SC-ST	LC-SC	LC-ST	LC-LC
1m	85559	85568	85577	85586	85595	85604
2m	85560	85569	85578	85587	85596	85605
3m	85561	85570	85579	85588	85597	85606
5m	85562	85571	85580	85589	85598	85607
7m	85563	85572	85581	85590	85599	85608
10m	85564	85573	85582	85591	85600	85609
15m	85565	85574	85583	85592	85601	85610
20m	85566	85575	85584	85593	85602	85611
30m	85567	85576	85585	85594	85603	85612

C2G'S VALUE PROPOSITION

C2G makes finding, buying and selling cables and connectivity easy so our partners can maximise profit from our products by leveraging our knowledge and experience.



88066



305M CAT6 UTP 550MHZ SOLID PVC CMG-RATED CABLE

CM/CMG-rated for single floor, general purpose use in walls and ceilings; foot-marked cable in easy-to-use pull box

With gigabit Ethernet, broadband, audio/video and security capabilities, our Cat6 bulk cable is ideal for network installation in your home, office, or on the entire campus. Foot-marked cable is packaged in a reel-in-box packaging for easier installation.

Item #	Description
88066	305m Cat6 UTP 550MHz Solid PVC CMG-Rated Cable – Grey
88067	305m Cat6 UTP 550MHz Solid PVC CMG-Rated Cable – Blue

88034



305M CAT6 UTP 350MHZ SOLID PVC CMG-RATED CABLE

CM/CMG-rated for single floor, general purpose use in walls and ceilings; foot-marked cable in easy-to-use pull box.

With Gigabit Ethernet, broadband, audio/video and security capabilities, our Cat6 bulk cable is ideal for network installation in your home, office, or on the entire campus. Foot-marked cable is packaged in reel-in-box packaging for easier installation.

Item #	Description
88034	305m Cat6 UTP 350MHz Solid PVC CMG-Rated Cable – Grey
88035	305m Cat6 UTP 350MHz Solid PVC CMG-Rated Cable – Blue

88001



305M CAT5E UTP 350MHZ SOLID PVC CMR-RATED CABLE

CMR-rated for in-wall and conduit use; foot-marked cable in easy-to-use pull box

With voice, data and security capabilities, our CMR-rated Cat5e bulk cable is ideal for network installation in your home, office, or on the entire campus. Footmarked cable is packaged in an easy-to-pull box for easier installation.

Item #	Description
88000	305m Cat5e UTP 350MHz Solid PVC CMR-Rated Cable – Grey
88001	305m Cat5e UTP 350MHz Solid PVC CMR-Rated Cable – Blue
88002	305m Cat5e UTP 350MHz Solid PVC CMR-Rated Cable – White
88003	305m Cat5e UTP 350MHz Solid PVC CMR-Rated Cable – Red



ConnectXpress
Powered by C2G

Your on demand connectivity expert.

ConnectXpress makes it simple to quickly and conveniently find a product for your application. Start by selecting the connectivity solution category that matches your application or device then choose your connector type, colour, length or other special options and you'll be presented with only the products that meet your needs. If you're not sure what you need, select the device you are trying to connect and discover the device's common connectors.

Available online 24/7. Go to <http://www.c2g.com/uk/connectxpress> to get started.





83865

3M RJ11 6P4C STRAIGHT MODULAR CABLE

For RS232 modular adapters for dumb terminal hookups and other serial/parallel extension applications

Constructed from 28AWG silver satin wire, this straight through-pinned cable is ideal for cost-saving voice and data applications not requiring high data rates. Connector 1: RJ11 (6P4C) Straight/ Connector 2: RJ11 (6P4C) Straight.

Item #	Description
83865	3m RJ11 6P4C Straight Modular Cable
83866	5m RJ11 6P4C Straight Modular Cable
83867	10m RJ11 6P4C Straight Modular Cable



88122

RJ45 CAT5 MODULAR PLUGS

Terminates cable in voice/data applications

Absolutely brilliant solution to customise your lengths of modular or Cat5e network cables. These modular plugs are manufactured from high impact clear polycarbonate to withstand everyday wear and tear, and have gold-plated contacts for error-free data transfer for voice and data applications.

Item #	Description
88121	RJ45 Cat5e Modular Plug Flat Stranded Cable – 25Pk
88122	RJ45 Cat5e Modular Plug Flat Stranded Cable – 50Pk
88123	RJ45 Cat5e Modular Plug Rounded Stranded Cable – 50Pk
88124	RJ45 Cat5e Modular Plug Round Solid Stranded Cable – 50Pk
88125	RJ45 Cat5e Modular Plug Round Solid Stranded Cable – 100Pk
88126	RJ45 Cat5e Modular Plug Round Solid Cable – 100Pk

81556



CAT5E RJ45 MODULAR INLINE COUPLER

Connect two Cat5e patch cables to make a longer connection

This coupler provides a female-to-female feed-through connection to extend the length of two Cat5e patch cables. Capable of handling LAN speeds up to 100Mbps, this coupler meets TIA/EIA 568A specifications and is Power Sum Certified. Use for straightthrough RJ45 Cat5e data applications.

Item #	Description
81556	Cat5e RJ45 Modular Inline Coupler

82838



RJ45 CAP

Protect an unused Ethernet port when it is not in use

The RJ45 cap is constructed of high quality ABS plastic and is designed for durability and a long life.

Item #	Description
82838	RJ45 Cap



81136

NETWORK INSTALLATION TOOL KIT

Be prepared to terminate and test all the different types of network cables

- One crimper for 8P8C/RJ45, 6P6C/RJ12, and 6P4C/RJ11
- One crimper with interchangeable die for RG58, RG59, 62.5, and 174
- Die sets for RG58, RG59, 62.5; RG58, RG59, 62.5, 174 fibre optic; RG174, 179, Belden 8218, fibre optic; RG8, 11, 174, 179, 213
- One 16.5cm cable cutter
- One cable stripper with cutter
- One coaxial cable stripper
- One punchdown tool with 66/88/110 blades
- One coaxial stripper
- Two screwdrivers
- One enhanced network cable tester
- One hard plastic case with inner foam padding

Item #	Description
81136	Network Installation Tool Kit

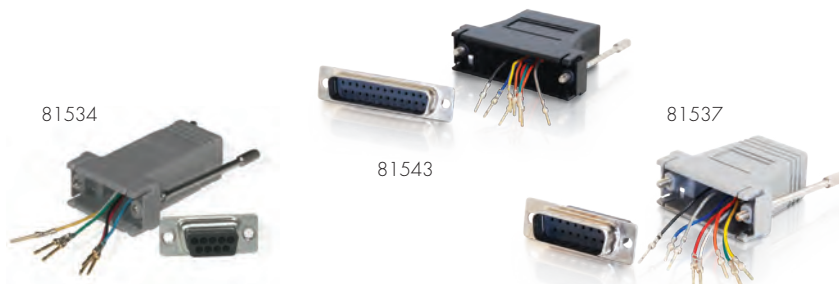

RJ12/RJ45 MODULAR ADAPTERS

Cost effective solution to connect serial printers, terminals, modems, POS devices and other serial equipment

Using modular adapters with inexpensive silver satin or flat oval, twisted pair wire has become a standard way to run client server applications. Needing to connect dumb terminals on the desktop back to a central patch panel or directly to a MUX via RS232, many network planners have implemented modular adapters as the most cost effective way to complete the connections.

Item #	Description
81534	RJ12/DB9 Female Modular Adapter – Grey
81535	RJ12/DB9 Male Modular Adapter – Grey
81536	RJ45/DB15 Male Modular Adapter – Grey
81537	RJ45/DB15 Female Modular Adapter – Grey
81538	RJ45/DB25 Female Modular Adapter – Grey
81543	RJ45/DB25 Male Modular Adapter – Black
81545	RJ45/DB9 Female Modular Adapter – Blue
81547	RJ45/DB9 Female Modular Adapter – Red
81548	RJ45/DB9 Male Modular Adapter – Grey
81549	RJ45/DB9 Male Modular Adapter – Blue
81550	RJ45/DB9 Male Modular Adapter – Black
81551	RJ45/DB9 Male Modular Adapter – Red
81553	RJ45 10-Pin/DB25 Male Modular Adapter – Grey
81554	RJ45 10-Pin/DB9 Female Modular Adapter – Grey
81555	RJ45 10-Pin/DB9 Male Modular Adapter – Grey



88130

HOOK-AND-LOOP CABLE MANAGEMENT STRAPS – BLACK – 12PK

Each high-strength nylon strap holds about 63.5mm diameter of cables; 12 per package

Quickly secure your cable runs for your audio/video equipment stack, computer desk or networking closet. These high-strength nylon-binding straps are easy to use and reuse with their self-attaching, hook-and-loop design.



88141

CABLE WRAPS – BLACK – 50PK

Organise your cables for maximum efficiency; holds 28mm diameter of cables

Effectively organise your audio/video equipment stack, computer desk or networking closet. These superior quality nylon ties are easy to use and reuse with their self-attaching, hook-and-loop design. Each wrap is 152mm long and 19mm wide to provide a 28mm diameter holding capacity.



82080

HOOK-AND-LOOP CABLE WRAP

Custom-cut the length you need and save money

In a jiffy, you can organise the cabling on your audio/video equipment stack, computer desk or in the networking closet. Create your own hook-and-loop nylon ties, cut to the size you need. Trim the right amount of cable wrap from the bulk reel with NO waste.

Item #	Description
88130	280mm Hook-and-Loop Cable Management Straps – Black – 12pk
88131	150mm Hook-and-Loop Cable Management Straps – Black – 12pk

Item #	Description
88141	156mm Cable Wraps – Black – 50 Pack

Item #	Description
82080	7.6m Hook-and-Loop Cable Wrap



88140

CABLE CLAMP – BLACK – 50PK

Bundle cables for a neat, organised installation

Absolutely brilliant solution to make wiring and cable installations clean and well organised. These cable clamps allow you to easily mount cable bundles to the wall, ceiling or any surface desired. These cable clamps have a self-adhesive pad on the back that makes toolless installation a breeze.

Item #	Description
88140	17mm Cable Clamp – Black – 50pk



88137

CABLE TIES

Bundle cables then just zip and secure for an organised installation

Cable ties make wiring and cable installations clean and well organised. Use them to bundle and secure wire and cable, these ties are very easy to use; simply zip and secure, with most having the option to release and reposition. With a tensile strength of 22 kg, these ties are strong for high quality performance. Packages contain 100 cable ties.

Item #	Description
88136	300mm Cable Ties – White – 100pk
88137	150mm Releasable Cable Ties – Black – 100pk
88138	190mm Releasable Cable Ties – Black – 100pk
88139	300mm Releasable Cable Ties – Black – 100pk

Custom Manufactured Cables

Experience the Flexibility of Custom Capabilities

For almost three decades, C2G has created custom cables for thousands of customers. We offer both custom design and cost effective manufacturing techniques to ensure you get the right solution, right on time. With our vast experience, we have perfected the elements necessary to meet our customers' cabling needs: quality, flexibility, service and competitive pricing.

Benefits:

Over 80% of our quotes are returned to the customer within one business day.

- Domestic and international manufacturing locations
- Rapid engineering and prototyping services
- Quick-turn prototyping available for sample approval
- Short-runs can accommodate single quantity orders
- Quick-transition manufacturing to our high-production facility in mainland China helps our customers achieve economies of scale while maintaining critical timelines
- Guaranteed cable quality
- Rapid production of fibre optic network cables including patch cords, pre-terms and MTP
- Fabrication of customer-specific custom cable assemblies and harnesses
- Production of custom cable assemblies for highly-integrated specifications
- Production and kitting of value added cable assemblies that include PCBs, housing or metal fabrication
- Customised kitting, packaging and labelling available



Custom Cable Offering:

- | | | |
|-----------------------------|---------------------------------|--------------------------------------|
| – Audio/Video Cables | – Gender Changers & Adapters | – PC Parallel Cables |
| – Cat5, Cat5e, Cat6 & Cat6a | – HDMI & DVI Cables | – VHDCI Cables |
| – Custom ODM Cables | – IEEE 1284 Cables | – RS232 Cables |
| – Custom OEM Cables | – Keyboard & Mouse Cables | – SCSI 1, 2, & 3 Cables/Terminators |
| – Fibre Optic Cables | – Modular Line Cords & Adapters | – Telco & Multi-Leg Telephone Cables |
| – Fibre Channel | – P&D (VESA) Cables | – USB & FireWire IEEE-1394 Cables |
| – Flat Ribbon Cables | – PC Card I/O Cables | |

Multiple Connectors and Hood Styles Available:

- | | | |
|------------|-------------|-----------------|
| – DB | – Retention | – V.35 |
| – Mini Din | – Angle | – Centronics |
| – Modular | – SCSI | – DIN Pins |
| – HD | – DIN Style | – Mini DIN Pins |

From simple labelling of stocked products, to advanced assemblies with multiple connectors—challenge us to develop the cable you need! All of our custom cables are backed by a lifetime guarantee against defects in workmanship.

Contact your preferred, C2G distribution partner to discuss your custom cable project.

AUDIO/VIDEO SOLUTIONS



CONFERENCE EXTENDER

For use with Logitech® ConferenceCam Group or CC3000E



84019



Logitech ConferenceCam Group



Logitech ConferenceCam CC3000e

BREAK FREE OF LENGTH LIMITATIONS

This extension kit provides the ability to mount a Logitech ConferenceCam Group or CC3000e Camera* or Speakerphone* up to 30 metres away from the system hub. This solution requires two standard Cat5 or Cat6 cables for extension. Installation is made easy through labeling and color coding.

INSTALLATION DIAGRAM FOR EXTENSION OF CC3000E CAMERA OR SPEAKERPHONE

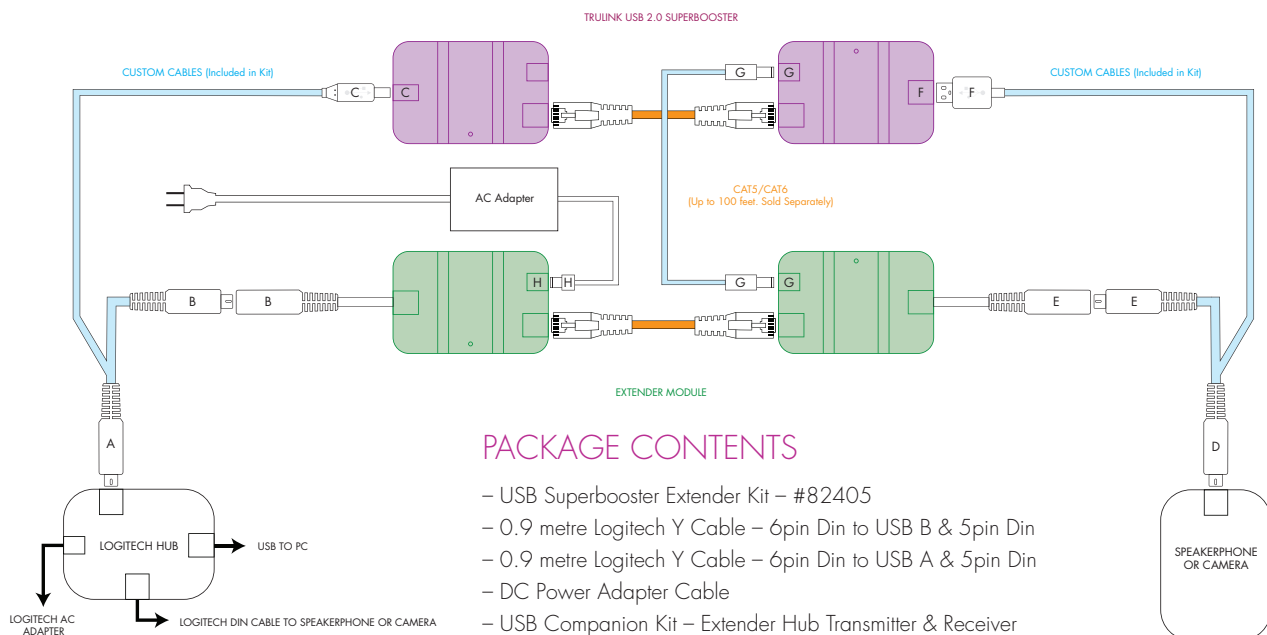

PACKAGE CONTENTS

- USB Superbooster Extender Kit – #82405
- 0.9 metre Logitech Y Cable – 6pin Din to USB B & 5pin Din
- 0.9 metre Logitech Y Cable – 6pin Din to USB A & 5pin Din
- DC Power Adapter Cable
- USB Companion Kit – Extender Hub Transmitter & Receiver
- Quick Start Guide

81000



PRO SERIES HD15 UXGA M/M MONITOR CABLE

Need high resolution video for your splitter, switch or projector? No problem.

Constructed from premium grade composite coaxial and twisted pair shielded cables, this ultra-premium monitor cable ensures crisp, distortion-free video so you have maximum monitor positioning flexibility. Uses three internal coax lines for red, green and blue. Ferrited to protect against EMI/RFI interference, this double-shielded cable consists of 125% foil shielding and 90% tinned copper braid shielding. Use it for video projectors, video splitters, KVM switches within video presentations, classroom environments, POS devices, server rooms, etc.

Item #	Description
81000	0.5m HD15 UXGA M/M Monitor Cable
81001	1m HD15 UXGA M/M Monitor Cable
81002	2m HD15 UXGA M/M Monitor Cable
81003	3m HD15 UXGA M/M Monitor Cable
81004	5m HD15 UXGA M/M Monitor Cable
81005	7m HD15 UXGA M/M Monitor Cable
81006	10m HD15 UXGA M/M Monitor Cable
81007	15m HD15 UXGA M/M Monitor Cable
81008	20m HD15 UXGA M/M Monitor Cable
81009	25m HD15 UXGA M/M Monitor Cable
81010	30m HD15 UXGA M/M Monitor Cable

81014



PRO SERIES HD15 UXGA M/F MONITOR EXTENSION CABLE

Need high resolution video to extend for your splitter, switch or projector? No problem.

This ultra-premium monitor cable ensures crisp, distortion-free video so you have maximum monitor positioning flexibility. Uses three internal coax lines for red, green and blue. Ferrited to protect against EMI/RFI interference, this double-shielded cable consists of 125% foil shielding and 90% tinned copper braid shielding.

Item #	Description
81014	2m HD15 UXGA M/F Monitor Extension Cable
81015	3m HD15 UXGA M/F Monitor Extension Cable
81016	5m HD15 UXGA M/F Monitor Extension Cable
81017	7m HD15 UXGA M/F Monitor Extension Cable
81018	10m HD15 UXGA M/F Monitor Extension Cable
81019	15m HD15 UXGA M/F Monitor Extension Cable
81020	20m HD15 UXGA M/F Monitor Extension Cable
81021	25m HD15 UXGA M/F Monitor Extension Cable
81022	30m HD15 UXGA M/F Monitor Extension Cable

81026



HD15 UXGA + 3.5MM AUDIO M/M MONITOR CABLE

Need great sound and high resolution video to travel up to 100 feet for your splitter, switch or projector? No problem.

Go the distance without ghosting and signal distortion, and quickly attach your desktop PC to a video display system with speakers. Use it with projectors, flat-screen monitors, KVM switches with audio, speakers or a microphone for video presentations, projector applications, and classroom environments.

Item #	Description
81027	1m UXGA + 3.5mm Audio M/M Monitor Cbl
81028	2m UXGA + 3.5mm Audio M/M Monitor Cbl
81029	3m UXGA + 3.5mm Audio M/M Monitor Cbl
81030	5m UXGA + 3.5mm Audio M/M Monitor Cbl
81031	7m UXGA + 3.5mm Audio M/M Monitor Cbl
81032	10m UXGA + 3.5mm Audio M/M Monitor Cbl
81033	15m UXGA + 3.5mm Audio M/M Monitor Cbl
81034	20m UXGA + 3.5mm Audio M/M Monitor Cbl
81035	25m UXGA + 3.5mm Audio M/M Monitor Cbl

81128



FLEXIMA™ HD15 UXGA M/M MONITOR CABLE

This ultra-flexible design makes installations in tight spaces easy and is rated for in-wall installation

The Flexima UXGA cable delivers high performance AND flexibility. This ultra-thin cable is highly flexible to make installation in even the tightest areas a breeze. Unlike cheap VGA cables, the Flexima cable will not coil or snag during installation.

Item #	Description
81129	3m Flexima HD15 UXGA M/M Monitor Cable
81130	5m Flexima HD15 UXGA M/M Monitor Cable
81131	7m Flexima HD15 UXGA M/M Monitor Cable
81132	10m Flexima HD15 UXGA M/M Monitor Cable
81133	15m Flexima HD15 UXGA M/M Monitor Cable
81134	20m Flexima HD15 UXGA M/M Monitor Cable
81135	30m Flexima HD15 UXGA M/M Monitor Cable

81084



PREMIUM SHIELDED HD15 SXGA M/M MONITOR CABLE

Ultra-premium, double-shielded monitor cables for your PC

Gain maximum flexibility in positioning your VGA card and monitor with this premium shielded cable. This VGA cable is ideal for video splitters, KVM switches, video presentations, classroom environments, POS, server rooms, or just for organising your work area for maximum comfort and efficiency.

Item #	Description
81084	0.5m HD15 SXGA M/M Monitor Cable
81085	1m HD15 SXGA M/M Monitor Cable
81086	2m HD15 SXGA M/M Monitor Cable
81087	3m HD15 SXGA M/M Monitor Cable
81088	5m HD15 SXGA M/M Monitor Cable
81089	7m HD15 SXGA M/M Monitor Cable
81090	10m HD15 SXGA M/M Monitor Cable
81091	15m HD15 SXGA M/M Monitor Cable

81095



PREMIUM SHIELDED HD15 SXGA M/F MONITOR EXTENSION CABLE

Extend the connection from your monitor, video splitter, or KVM switch to your PC

Gain maximum flexibility in positioning your VGA card and monitor with this extension cable. This premium VGA cable is ideal for video splitters, KVM switches, video presentations, classroom environments, POS, server rooms, or just for organising your work area for maximum comfort and efficiency.

Item #	Description
81095	0.5m Shielded HD15 SXGA M/F Monitor Ext.
81096	1m Shielded HD15 SXGA M/F Monitor Ext.
81097	2m Shielded HD15 SXGA M/F Monitor Ext.
81098	3m Shielded HD15 SXGA M/F Monitor Ext.
81099	5m Shielded HD15 SXGA M/F Monitor Ext.
81100	7m Shielded HD15 SXGA M/F Monitor Ext.
81101	10m Shielded HD15 SXGA M/F Monitor Ext.
81102	15m Shielded HD15 SXGA M/F Monitor Ext.

81040



PREMIUM SHIELDED HD15 SXGA M/M MONITOR CABLE WITH 90° UP-ANGLED MALE CONNECTOR

Angled 90° connector enables easy installation—even in the tightest spots

Gain maximum flexibility in positioning your monitor with this angled connector cable. The right-angled connector allows installation in even the tightest locations. This premium VGA cable is ideal for video presentation devices, video splitters, and KVM switches.

Item #	Description
81040	0.5m HD15 SXGA M/M Monitor Cable/90°
81041	1m HD15 SXGA M/M Monitor Cable/90°
81042	2m HD15 SXGA M/M Monitor Cable/90°
81043	3m HD15 SXGA M/M Monitor Cable/90°
81044	5m HD15 SXGA M/M Monitor Cable/90°
81045	7m HD15 SXGA M/M Monitor Cable/90°
81046	10m HD15 SXGA M/M Monitor Cable/90°
81047	15m HD15 SXGA M/M Monitor Cable/90°

81073



PREMIUM SHIELDED HD15 SXGA M/F MONITOR EXTENSION CABLE WITH 90° DOWN-ANGLED MALE CONNECTOR

Angled 90° connector enables easy installation—even in the tightest spots

Gain maximum flexibility in positioning your monitor with this angled connector cable. The right-angled connector allows installation in even the tightest locations; the cable breaks down from this connector.

Item #	Description
81073	0.5m HD15 SXGA M/F Monitor Cable w/90°
81074	1m HD15 SXGA M/F Monitor Cable w/90°
81075	2m HD15 SXGA M/F Monitor Cable w/90°
81076	3m HD15 SXGA M/F Monitor Cable w/90°
81077	5m HD15 SXGA M/F Monitor Cable w/90°
81078	7m HD15 SXGA M/F Monitor Cable w/90°
81079	10m HD15 SXGA M/F Monitor Cable w/90°
81080	15m HD15 SXGA M/F Monitor Cable w/90°

VGA CABLES & ADAPTERS

81051



PREMIUM SHIELDED HD15 SXGA M/F MONITOR EXTENSION CABLE WITH 90° UP-ANGLED MALE CONNECTOR

Angled 90° connector enables easy installation—even in the tightest spots

Gain maximum flexibility in positioning your monitor with this angled connector cable. The right-angled connector allows installation in even the tightest locations; the cable breaks up from this connector. This premium VGA extension cable is ideal for video presentation devices, video splitters, and KVM switches.

Item #	Description
81051	0.5m Premium Shielded HD15 SXGA M/F Monitor Ext. Cable with 90° Up Connector
81052	1m Premium Shielded HD15 SXGA M/F Monitor Ext. Cable with 90° Up Connector
81053	2m Premium Shielded HD15 SXGA M/F Monitor Ext. Cable with 90° Up Connector
81054	3m Premium Shielded HD15 SXGA M/F Monitor Ext. Cable with 90° Up Connector
81055	5m Premium Shielded HD15 SXGA M/F Monitor Ext. Cable with 90° Up Connector
81056	7m Premium Shielded HD15 SXGA M/F Monitor Ext. Cable with 90° Up Connector
81057	10m Premium Shielded HD15 SXGA M/F Monitor Ext. Cable with 90° Up Connector

81062



PREMIUM SHIELDED HD15 SXGA M/M MONITOR CABLE WITH 90° DOWN-ANGLED MALE CONNECTOR

Angled 90° connector enables easy installation—even in the tightest spots

Gain maximum flexibility in positioning your monitor with this angled connector cable. The right-angled connector allows installation in even the tightest locations; the cable breaks down from this connector. This premium VGA cable is ideal for video presentation devices, video splitters, and KVM switches.

Item #	Description
81062	0.5m Premium Shielded HD15 SXGA M/M Monitor Cable with 90° Down-Angled Connector
81063	1m Premium Shielded HD15 SXGA M/M Monitor Cable with 90° Down-Angled Connector
81064	2m Premium Shielded HD15 SXGA M/M Monitor Cable with 90° Down-Angled Connector
81065	3m Premium Shielded HD15 SXGA M/M Monitor Cable with 90° Down-Angled Connector
81066	5m Premium Shielded HD15 SXGA M/M Monitor Cable with 90° Down-Angled Connector
81067	7m Premium Shielded HD15 SXGA M/M Monitor Cable with 90° Down-Angled Connector
81068	10m Premium Shielded HD15 SXGA M/M Monitor Cable with 90° Down-Angled Connector
81069	15m Premium Shielded HD15 SXGA M/M Monitor Cable with 90° Down-Angled Connector

81161



ECONOMY HD15 SVGA M/M AND M/F MONITOR CABLES

Connect a monitor, video splitter, or KVM switch to your desktop PC

This cable is constructed from 28AWG wire, and is foil shielded to protect your short cable runs from EMI/RFI interference. The fully snagless connectors have easy-to-use extra long thumbscrews for a fast connection. Use for video presentations, classroom environments, or just for organising your work area.

Item #	Description
81161	2m Economy HD15 SVGA M/M Monitor Cable
81162	3m Economy HD15 SVGA M/M Monitor Cable
81163	5m Economy HD15 SVGA M/M Monitor Cable
81167	2m Econ HD15 SVGA M/F Monitor Ext Cable
81168	3m Econ HD15 SVGA M/F Monitor Ext Cable
81169	5m Econ HD15 SVGA M/F Monitor Ext Cable

81167



81173



ECONOMY HD15 MALE TO DUAL FEMALE SVGA Y CABLE-20CM

Splits video input from a single source and directs it to two video outputs

The video SVGA Y cable from C2G, allows you to share video easily and is ideal for presentations. It splits the SVGA signal, providing simultaneous display of the same picture. The video SVGA Y cable makes connecting two monitors a snap. This cable works with any two VGA/SVGA type monitors that use standard 15-pin plugs.

Item #	Description
81173	ECO SVGA HD15 M to (2) HD15 F Y Cable

81174



ULTIMA™ ONE HD15 MALE TO TWO HD15 FEMALE SXGA MONITOR Y CABLE-30CM

An ultra-premium, high-performance cable to split your VGA signal

The Ultima SXGA cable optimises style, quality, and value in a cable specially designed for high performance. This Y cable splits the VGA signal to provide simultaneous display of the same picture. It is constructed from three individually-shielded 75Ohm coax and four twisted pair cable to minimise crosstalk, noise, and other EMI/RFI interference. An aluminium undermould shield assists in reducing interference to meet FCC requirements, while a 360° solder-to-connector shell and cable braid create an end-to-end shielding solution for a noise-free connection.

Item #	Description
81174	Ultima SXGA HD15 M to (2) HD15 F Y Cable

80931



HD15 VGA PORT SAVER ADAPTERS

Low profile to save space and protect the port on your laptop. These port saver adapters help your system withstand the stress of plugging and unplugging cables and will easily extend the life of your equipment's connectors.

81528



HD15 VGA GENDER CHANGERS

Quickly change the gender, or join two cables together. Save the cost and hassle of buying a new cable by just changing the gender of your existing port and using the cable you already have. Each changer is snagless and fully shielded.

Item #	Description
80931	HD15 M/F Mini Port Saver Adapter
81525	HD15 F/F Gender Changer Coupler
81527	HD15 M/M Mini Gender Changer Coupler
81528	HD15 M/F Port Saver Adapter
81529	HD15 F/F Mini Gender Changer Coupler
80930	13W3 M to HD15 F Special Pinning Adapter

81232



PREMIUM HD15 MALE TO RGBHV (5-BNC) MALE VIDEO CABLE

Provides a crisp video image for monitors, HDTV and other video applications

This cable is constructed from premium quality 75Ohm mini coax wire to ensure a crisp monitor image. Low loss 75Ohm impedance and polyethylene dielectric provide an accurate picture resolution and colour. Each wire is shielded with 100% foil shielding and 85% copper braid that is soldered 360° to the connector shell to create a shielding solution for a vivid, noise-free image.

Colour-coding of the five separated monitor signals provides easy identification of red, green, and blue leads with horizontal and vertical sync.

Item #	Description
81232	2m HD15 Male to 5-BNC Male Video Cable
81233	3m HD15 Male to 5-BNC Male Video Cable
81234	5m HD15 Male to 5-BNC Male Video Cable

80355



ULTIMA™ HD15 MALE TO RCA HDTV COMPONENT VIDEO BREAK-OUT CABLE

Enjoy superior picture quality for satellite TV, HDTV, component RGB video, Y/Pb/Pr video and most LCD projectors

The Ultima cable optimises style, quality, and value in a cable specially designed for high performance. Constructed from three individually shielded, 75Ohm coax cables, this cable delivers a performance connection that maximises colour and image. The cable features 100% shield with an overlapped foil and copper braid. This design assists in reducing EMI/RFI interference to meet FCC requirements.

Item #	Description
80355	1m Ultima HDTV Video Cable HD15 M 3RCA
80356	2m Ultima HDTV Video Cable HD15 M 3RCA
80357	3m Ultima HDTV Video Cable HD15 M 3RCA

VGA CABLES & ADAPTERS

81241



M1 MALE TO HDMI FEMALE ADAPTER

For ASK Proxima® and InFocus projectors plus select Dell®, Hitachi, Toshiba™ and ViewSonic® projectors and other devices with M1 connectors.

M1 projectors provide the flexibility of connecting to either VGA or DVI inputs. This adapter enables you to utilise your standard display cables to connect to M1 projectors and other devices that employ the universal M1 connector.

Item #	Description
81241	M1 Male to HDMI Female Adapter

81226



ONE LFH-59 (DMS-59) MALE TO ONE DVI-I FEMALE AND ONE HD15 VGA FEMALE CABLE-22CM

Connect a 59/60 pin graphics card connector to a monitor with a DVI-I connector, and a monitor with a HD15 connector

Connect your nVIDIA® or PNY®, Quadro®, or Matrox® QID multiple display graphics cards with our LFH-59 cables with gold-plated contacts that provide full conductivity with no data loss. Many high end work stations utilise multiple display graphics cards that only have a single LFH-59 or LFH-60 (also known as DMS-59 and DMS-60) connection. A break-out cable is necessary to convert this single connection into two more common monitor interfaces, such as DVI or VGA.

Item #	Description
81226	LFH-59 to DVI and VGA Cable-22cm
81227	LFH-59 to (2) DVI Cable-22cm
81228	LFH-59 to (2) VGA Cable-22cm

81726



2-PORT VGA + USB MICRO KVM WITH AUDIO

Compact design saves space; all cables included with nothing more to buy

Take control of two desktop PCs and free your desktop from clutter with our 2-Port VGA and USB Micro KVM with Audio. This powerful, compact KVM solution provides everything you need to control two desktop PCs from a single USB keyboard/mouse, monitor, and speaker set. Fully integrated, single-jacket cables attach to your desktop PCs to eliminate tangles and provide a neat, clean appearance. The small footprint of the switch makes it ideal for desktop applications.

Item #	Description
81726	2-Port VGA + USB Micro KVM with Audio

Configuration Solutions



HDMI



Mini HDMI



Micro HDMI



VGA



DVI

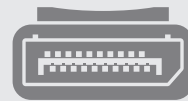

DisplayPort



Stereo Audio

- HDMI / Mini HDMI / Micro HDMI
- HDMI in tight spaces
- HDMI to VGA
- HDMI to VGA + Audio

- HDMI to DVI
- HDMI to DisplayPort
- Mini HDMI to DVI
- Mini HDMI to VGA

- Mini HDMI to VGA + Audio
- Mini HDMI to HDMI
- Micro HDMI to VGA + Audio

81205



DVI-A MALE TO HD15 VGA MALE ANALOGUE VIDEO CABLE

Connect a computer's VGA port to a monitor's DVI-A/DVI-I connector

Digital Visual Interface (DVI) is the standard interface for a high performance connection between desktop PCs and flat panel displays, CRT displays, projectors, and HDTVs. Three analogue 30AWG coaxial lines enable high speed analogue transmission.

Item #	Description
81205	1m DVI-A Male to HD15 Male Video Cable
81206	2m DVI-A Male to HD15 Male Video Cable
81207	3m DVI-A Male to HD15 Male Video Cable
81208	5m DVI-A Male to HD15 Male Video Cable

81211



DVI-A FEMALE TO HD15 VGA MALE ANALOGUE VIDEO EXTENSION CABLE

Extend an existing VGA cable for use with a DVI-A/DVI-I connector

Digital Visual Interface (DVI) is the standard interface for high performance connection between desktop PCs and flat panel displays, CRT displays, projectors, and HDTVs.

Item #	Description
81211	2m DVI-A Female to HD15 Male Ext. Cable
81216	2m DVI-A Male to HD15 Female Ext. Cable

81221



DVI-A VIDEO ADAPTERS

Convert an analogue DVI-A cable to use with a VGA device; maximum resolution is 1600x1200 pixels

This analog video adapter is fully compliant with the DVI standard defined by DDWG (Digital Display Working Group). The DVI-A analog configuration adapts an existing VGA cable for use with an analog DVH device. Maximum resolution is UXGA (1600x1200 pixels).

Item #	Description
81221	DVI-A Female to SVGA HD15 Male Video Adp
81222	DVI-A Male to SVGA HD15 Female Video Adp

81199



DVI-I M/M SINGLE LINK DIGITAL/ANALOGUE VIDEO CABLE

High performance cable connects desktop PCs to flat panel displays, digital CRT displays, and projectors

This precision-engineered cable is fully compliant with the DVI standard defined by DDWG (Digital Display Working Group). The DVH single link configuration provides enough bandwidth for resolutions up to 1600x1200 pixels and allows high speed transmission up to 4.95Gbps. Three analogue 30AWG coaxial lines enable high speed analogue transmission.

Tri-shielded undermould with dual foil and braid shield protects against unwanted EMI/RFI interference.

Item #	Description
81199	1m DVI-I M/M Single Link Video Cable
81200	2m DVI-I M/M Single Link Video Cable
81201	3m DVI-I M/M Single Link Video Cable
81202	5m DVI-I M/M Single Link Video Cable

81178



DVI-I M/M DUAL LINK DIGITAL/ANALOGUE VIDEO CABLE

High performance cable connects desktop PCs to flat panel displays, digital CRT displays, projectors and HDTVs

This precision-engineered cable is fully compliant with the DVI standard defined by DDWG (Digital Display Working Group). The DVH single link configuration provides enough bandwidth for resolutions up to 2048x1536 pixels.

Item #	Description
81178	1m DVI-I M/M Dual Link Video Cable
81179	2m DVI-I M/M Dual Link Video Cable
81180	3m DVI-I M/M Dual Link Video Cable
81181	5m DVI-I M/M Dual Link Video Cable
81184	2m DVI-I M/F Video Extension Cable
81185	3m DVI-I M/F Video Extension Cable

82018



PRO SERIES DVI-D CL2 M/M SINGLE LINK DIGITAL VIDEO CABLE

Pro Series commercial grade CL2 cables offer true digital performance

The new Pro Series commercial grade CL2 cables offer true digital performance while meeting the highest standards in building code requirements for in-wall installations. Available for HDMI, DVI and DVI + 3.5mm audio signals, these cables can meet the demands of virtually any commercial installation.

Item #	Description
82018	7.6m Pro Series DVI-D M/M Single Link Cable
82019	10.6m Pro Series DVI-D M/M Single Link Cable
82020	15.2m Pro Series DVI-D M/M Single Link Cable
82021	19.8m Pro Series DVI-D M/M Single Link Cable
82022	22.8m Pro Series DVI-D M/M Single Link Cable
82023	30.4m Pro Series DVI-D M/M Single Link Cable

DVI CABLES & ADAPTERS

81184



DVI-I M/F DUAL LINK DIGITAL/ANALOGUE VIDEO EXTENSION CABLE

High performance cable extends your desktop PC connection to flat panel displays, digital CRT displays, and projectors

This precision-engineered cable is fully compliant with the DVI standard defined by DDWG (Digital Display Working Group). The DVH dual link configuration provides enough bandwidth for resolutions up to 2048x1536 pixels.

Item #	Description
81184	2m DVI-I M/F Video Extension Cable
81185	3m DVI-I M/F Video Extension Cable

81188



DVI-D M/M DUAL LINK DIGITAL VIDEO CABLE

High performance cable connects desktop PCs to flat panel displays, digital CRT displays, projectors, and HDTVs

This precision-engineered cable provides enough bandwidth for resolutions up to 2560x1600 pixels and allows high speed digital video transmission up to 9.9Gbps. Tri-shielded undermold with dual foil shield and braid shield protects against unwanted EMI/RFI interference.

Item #	Description
81187	0.5m DVI-D M/M Dual Link Digital Video Cable
81188	1m DVI-D M/M Dual Link Digital Video Cable
81189	2m DVI-D M/M Dual Link Digital Video Cable
81190	3m DVI-D M/M Dual Link Digital Video Cable
81191	5m DVI-D M/M Dual Link Digital Video Cable

81194



DVI-D M/F DUAL LINK DIGITAL VIDEO EXTENSION CABLE

High performance extension between desktop PCs and flat panel displays, digital CRT displays, projectors, and HDTVs

This precision-engineered cable is fully compliant with the DVI standard defined by DDWG (Digital Display Working Group). The DVH dual link configuration provides enough bandwidth for resolutions up to 2048x1536 pixels.

Item #	Description
81194	2m DVI-D M/F Digital Video Extension Cable
81195	3m DVI-D M/F Digital Video Extension Cable
81196	5m DVI-D M/F Digital Video Extension Cable

81530



DVI-D M/F PORT SAVER ADAPTER

Protect your display's port with this strong port adapter

Digital Visual Interface (DVI) is the standard interface for a high performance connection between desktop PCs and flat panel displays, digital CRT displays, projectors, and HDTVs. This adapter is fully compliant with the DVI standard defined by DDWG (Digital Display Working Group). The DVI-D dual link configuration provides enough bandwidth for resolutions up to 2048x1536 pixels, and is designed for high speed data transmission up to 9.9Gbps. Supports hot-plugging of DVI display devices. Gold-plated contacts provide full conductivity with no data loss. PC and Mac® compatible.

Item #	Description
81530	DVI-D M/F Video Adapter

82028



HDMI® TO DVI-D DIGITAL VIDEO CABLE

Deliver high definition video from source to display

The C2G HDMI to DVI-D Digital Video Cable is perfect for source to display connectivity for desktop or home theatre applications requiring connectivity between HDMI and DVI-D devices. This cable connects an HDMI source device to a DVI-D display or a DVI-D source device to an HDMI display. Backed by a lifetime warranty.

Item #	Description
82028	0.5m HDMI to DVI Cable
82029	1m HDMI to DVI Cable
82030	1.5m HDMI to DVI Cable
82031	2m HDMI to DVI Cable
82032	3m HDMI to DVI Cable
82033	5m HDMI to DVI Cable

80347



VELOCITY™ DVI-D MALE TO HDMI® FEMALE INLINE ADAPTER

Convert an HDMI cable to a DVI-D connection for your audio/video system

Use this adapter to provide a pure digital, high definition video connection. You'll see the purity of the original signal with absolutely no picture degradation. Fully tested and absolutely guaranteed. Gold-plated contacts deliver worry-free performance, and make this adapter an ideal choice to connect digital source components to DVI-equipped display devices. Ideal for satellite, DVD player, HDTV, plasma, LCD, and DLP applications. Don't compromise your high definition video signal—use the right interconnects.

Item #	Description
80347	HDMI F to DVI M Adapter-Black
80348	HDMI M to DVI F Adapter-Black

COMPARISON OF 4K ULTRA HD TO OTHER RESOLUTIONS

4K UHD is a resolution of 3840 pixels x 2160 lines (8.3 megapixels, aspect ratio 16:9). 4K UHD has twice the horizontal and vertical resolution of the 1080p HDTV format, with four times as many pixels overall.



80546



ACTIVE HIGH SPEED HDMI® CABLE IN-WALL

Supports up to a 1080p resolution at 60Hz, 3D video and Deep Color, making it the perfect fit for applications which require detailed image display

The Active High Speed HDMI Cable is the perfect solution for extending HDMI signals in classrooms, conference rooms, houses of worship, and other commercial environments. This cable features a built-in signal booster that supports HDMI A/V connections at longer distances than non-active cables. This cable does not require an external power adapter and is an ideal solution for making a connection between HDMI-enabled devices, such as a Blu-ray player, laptop, HDTV, projector, and more.

Item #	Description
80546	10m Active HDMI High Speed Cable In-Wall
80547	15m Active HDMI High Speed Cable In-Wall
80548	20m Active HDMI High Speed Cable In-Wall
80549	30m Active HDMI High Speed Cable In-Wall

80550



SELECT HIGH SPEED HDMI® WITH ETHERNET CABLE

In-wall rated cable for connecting a multimedia device to a display and supporting the latest HDMI features including Ultra HD, 4K at 50/60 (2160p), up to 32 audio channels, and wide angle theatrical 21:9 video aspect ratio

The C2G Select High Speed HDMI with Ethernet Cable is perfect for home theatre, desktop, and commercial audio video applications requiring high speed HDMI features and video resolutions up to 2160p. The CL2-rated cable jacket is designed to meet the requirements for in-wall installations.

*Only supports up to 1080i resolution

Item #	Description
80550	0.5m Select High Speed HDMI with Ethernet
80551	1m Select High Speed HDMI with Ethernet
80552	1.5m Select High Speed HDMI with Ethernet
80553	2m Select High Speed HDMI with Ethernet
80554	3m Select High Speed HDMI with Ethernet
80555	5m Select High Speed HDMI with Ethernet
80556	7m Select High Speed HDMI with Ethernet
80557	10m Select Standard Speed HDMI with Ethernet*
80558	15m Select Standard Speed HDMI with Ethernet*

82024



HIGH SPEED HDMI® WITH ETHERNET CABLE

Connect a multimedia device to a display and support the latest HDMI features including Ultra HD, 4K at 50/60 (2160p), up to 32 audio channels, and wide angle theatrical 21:9 video aspect ratio

This High Speed HDMI Cable with Ethernet is the perfect solution for connecting multimedia source devices in home theatre, desktop, or commercial audio video applications requiring high speed HDMI features.

Item #	Description
82024	0.5m HDMI High Speed with Ethernet Cable
82004	1m Value High Speed with Ethernet HDMI Cable
82025	1.5M HDMI High Speed with Ethernet Cable
82005	2m Value High Speed with Ethernet HDMI Cable
82006	3m Value High Speed with Ethernet HDMI Cable

82361



ULTRA FLEXIBLE HIGH SPEED HDMI® CABLE WITH LOW PROFILE CONNECTORS

Connect a multimedia device to a display and support the latest HDMI features including Ultra HD, 4K at 50/60 (2160p), up to 32 audio channels and wide angle theatrical 21:9 video aspect ratio

The Ultra Flexible High Speed HDMI Cable with Low Profile Connectors is perfect for home theater or desktop audio video applications requiring high speed HDMI features and video resolutions up to 1080p. The ultra-flexible cable construction and the low profile, compact connector design make this cable an ideal fit for installations in tight spaces.

Item #	Description
82361	0.3m Ultra Flexible High Speed HDMI Cable with Low Profile Connectors (1ft)
82362	0.6m Ultra Flexible High Speed HDMI Cable with Low Profile Connectors (2ft)
82363	0.9m Ultra Flexible High Speed HDMI Cable with Low Profile Connectors (3ft)
82364	1.8m Ultra Flexible High Speed HDMI Cable with Low Profile Connectors (6ft)

82007



HIGH SPEED HDMI® TO HDMI® MINI CABLE WITH ETHERNET

Connect a mobile device to a display and support the latest HDMI features including Ultra HD, 4K at 50/60 (2160p), up to 32 audio channels, and wide angle theatrical 21:9 video aspect ratio

This High Speed HDMI to HDMI Mini Cable with Ethernet is perfect for connecting a smartphone, tablet or other mobile device to an HD display for home theatre or desktop applications.

Item #	Description
82007	1m High Speed HDMI to HDMI Mini Cable with Ethernet
81999	1.5m High Speed HDMI to HDMI Mini Cable with Ethernet
82008	2m High Speed HDMI to HDMI Mini Cable with Ethernet
82009	3m High Speed HDMI to HDMI Mini Cable with Ethernet

82026



HIGH SPEED HDMI® TO HDMI® MICRO CABLE WITH ETHERNET

Connect a mobile device to a display and support the latest HDMI features including Ultra HD, 4K at 50/60 (2160p), up to 32 audio channels and wide angle theatrical 21:9 video aspect ratio

The C2G High Speed HDMI Micro with Ethernet Cable is perfect for a hand-held mobile or cell phone connectivity for home theatre or desktop applications requiring high speed HDMI features and video resolutions up to 2160p.

Item #	Description
82026	0.5m High Speed HDMI to HDMI Micro Cable with Ethernet
82010	1m High Speed HDMI to HDMI Micro Cable with Ethernet
82027	1.5m High Speed HDMI to HDMI Micro Cable with Ethernet
82011	2m High Speed HDMI to HDMI Micro Cable with Ethernet
82012	3m High Speed HDMI to HDMI Micro Cable with Ethernet

80146



VELOCITY™ HDMI® COUPLER

Extend an overall length by coupling two HDMI cables

It can often be difficult to predict where components will need to be placed in the future, or to calculate the needed cable length for an installation. Miscalculations often aren't noticed until the cable is already installed. When your installation leaves you short, save time and money and avoid the aggravation of running new cables by simply extending your existing HDMI connection.

Our HDMI female-to-female coupler will extend the distance of your existing HDMI cable by allowing two cables to be coupled together. It is compact and designed for minimal signal loss to provide an easy, quality connection between two HDMI cables. PCB design along with gold-plated connectors safeguards signal integrity.

Item #	Description
80146	Velocity HDMI Coupler

80562



HDMI® MALE TO HDMI® FEMALE 90° DOWN ADAPTER

Protects HDMI connectors and allows for connections with minimal clearance

In many new flat panel installations, space is crucial. Often there is not much clearance to fit the HDMI cable connector in the space between the flat panel and the wall. An additional problem is that the weight of the HDMI cable stresses the HDMI connector. Over time, this stress and the constant plugging and unplugging of cables can cause the HDMI connectors on your HD devices to wear down, become damaged, and even degrade picture quality.

Item #	Description
80562	HDMI Male to HDMI Female 90° Down Adapter

82236



USB POWERED HDMI® VOLTAGE INSERTER

Draws power from a USB port and provides a dedicated power supply for HDMI installations

The USB Powered HDMI Voltage Inserter is the ideal solution for a HDMI source device (cable box, DVD player, video game system) that does not provide enough power through the HDMI output for use with HDMI extensions, switches, splitters or other HDMI devices that rely on power from the HDMI output port of the source. Not using a voltage inserter in this application will cause a voltage drop and the video quality is affected, or worse, there is no video at all. This voltage inserter isolates the power from the source device and it provides 5 Volts and 1 Amp of dedicated power to give the crisp, clean signal that is expected from high definition equipment. Up to 1080p resolution.

Item #	Description
82236	USB Powered HDMI Voltage Inserter

80500



HDMI® ADAPTER CONVERTER DONGLES

Easily connect the HDMI video output of a small laptop to a computer monitor

These adapter converter dongles are an ideal solution for connecting the video output of a HDMI-enabled laptop to a VGA or DVI display. The dongle design of these adapter converters does not cause the stress on the port of a small laptop that is common when using a box style adapter. HD video resolution is supported, allowing these adapter converters to meet the needs of a high performance application. Connect this adapter directly to the output of a laptop and use a VGA or DVI cable to connect to a display.

Item #	Description
80500	HDMI Male to VGA Female Adapter Converter Dongle
80501	HDMI Male to VGA and Stereo Audio Female Adapter Converter Dongle
80502	HDMI Male to Single Link DVI-D™ Female Adapter Converter Dongle

80503



HDMI® MINI ADAPTER CONVERTER DONGLES

Easily connect the HDMI video output of a small laptop to a computer monitor

These adapter converter dongles are an ideal solution for connecting the video output of a HDMI Mini-enabled laptop to a VGA, DVI or HDMI display. The dongle design of these adapter converters does not cause the stress on the port of a small laptop that is common when using a box style adapter. HD video resolution is supported, allowing these adapter converters to meet the needs of a high performance application. Connect this adapter directly to the output of a laptop and use a VGA, DVI or HDMI cable to connect to a display.

Item #	Description
80503	HDMI Mini Male to VGA Female Adapter Converter Dongle
80504	HDMI Mini Male to VGA and Audio Female Adapter Converter Dongle
80505	HDMI Mini Male to Single Link DVI-D Female Adapter Converter Dongle
80506	HDMI Mini Male to HDMI® Female Adapter Converter Dongle

80509



HDMI® MICRO ADAPTER CONVERTER DONGLES

Easily connect the HDMI video output of a small laptop to a computer monitor

These adapter converter dongles are an ideal solution for connecting the video output of a HDMI Micro-enabled laptop to a VGA, DVI or HDMI display. The dongle design of these adapter converters does not cause the stress on the port of a small laptop that is common when using a box style adapter. HD video resolution is supported, allowing these adapter converters to meet the needs of a high performance application. Connect this adapter directly to the output of a laptop and use a VGA, DVI or HDMI cable to connect to a display.

Item #	Description
80509	HDMI Micro Male to VGA and Stereo Audio Female Adapter Converter Dongle
80510	HDMI Micro Male to HDMI Female Adapter Converter Dongle
80511	HDMI Micro Male to DVI Female Adapter Converter Dongle

DISPLAYPORT CABLES & ADAPTERS

84400



DISPLAYPORT™ CABLE WITH LATCHES M/M

Connect the DisplayPort output of a computer to the DisplayPort input of a computer monitor

This cable is an ideal solution for connecting the DisplayPort output of a laptop to a computer monitor which accepts a DisplayPort input. This cable carries a digital audio/video signal and the connectors feature latches which secure the cable in the port. Support of a High Bit Rate (HBR) bandwidth means that this cable can carry up to a 4K resolution. Built to DisplayPort 1.2 standards, this cable meets the requirements of high performance applications.

Item #	Description
84400	1m DisplayPort Cable w/Latches M/M - Black
84401	2m DisplayPort Cable w/Latches M/M - Black
84402	3m DisplayPort Cable w/Latches M/M - Black
84403	5m DisplayPort Cable w/Latches M/M - Black
84404	7m DisplayPort Cable w/Latches M/M - Black
84405	10m DisplayPort Cable w/Latches M/M - Black

84328



DISPLAYPORT™ MALE TO SINGLE LINK DVI-D MALE ADAPTER CABLE

Connect the DisplayPort output of a computer to the DVI input of a computer monitor

This adapter cable is an ideal solution for connecting the DisplayPort output of a laptop to a computer monitor which accepts a DVI-D input. This cable carries a digital video signal, supports up to a 1920x1200 resolution and meets the requirements of high performance applications.

Item #	Description
84328	1m DisplayPort Male to Single Link DVI-D Male Adapter Cable - Black
84329	2m DisplayPort Male to Single Link DVI-D Male Adapter Cable - Black
84330	3m DisplayPort Male to Single Link DVI-D Male Adapter Cable - Black

84331



DISPLAYPORT™ MALE TO SINGLE LINK DVI-D MALE ADAPTER CABLE

Connect the DisplayPort output of a computer to the DVI input of a computer monitor

This adapter cable is an ideal solution for connecting the DisplayPort output of a laptop to a computer monitor which accepts a VGA input. This cable carries an analogue video signal, supports up to a 1920x1200 resolution and meets the requirements of high performance applications.

Item #	Description
84331	1m DisplayPort Male to VGA Male Adapter Cable - Black
84332	2m DisplayPort Male to VGA Male Adapter Cable - Black
84333	3m DisplayPort Male to VGA Male Adapter Cable - Black

84325



DISPLAYPORT™ MALE TO HD MALE ADAPTER CABLE

Connect the DisplayPort output of a computer to the HDMI input of a HDTV or projector

This adapter cable is an ideal solution for connecting the DisplayPort output of a laptop to a HDTV or projector which accepts a HDMI input. This cable carries a digital audio/video signal, supports up to a 1080p resolution and meets the requirements of high performance applications.

Item #	Description
84325	1m DisplayPort Male to HD Male Adapter Cable - Black
84326	2m DisplayPort Male to HD Male Adapter Cable - Black
84327	3m DisplayPort Male to HD Male Adapter Cable - Black

81293



DISPLAYPORT™ F/F COUPLER

Easily extend overall cable length by connecting two DisplayPort cables

The DisplayPort Female to Female Coupler is the perfect solution for combining two DisplayPort cables to achieve connectivity over a longer distance. The coupler is compact and designed for minimal signal loss. The passive design of this coupler allows it to support video resolutions of up to 1080p.

Note: Standard signal length limitations apply to coupled cables.

Item #	Description
81293	DisplayPort F/F Coupler

84297



MINI DISPLAYPORT™ TO DISPLAYPORT™ ADAPTER CABLE M/M

Connect the Mini DisplayPort or Thunderbolt™ output of a computer to the DisplayPort input of a computer monitor

This adapter cable is an ideal solution for connecting the Mini DisplayPort output of a small laptop or tablet to a computer monitor which accepts a DisplayPort input. This cable carries a digital audio/video signal and supports up to a 4K resolution. Built to DisplayPort 1.2 standards, this cable meets the requirements of high performance applications.

Item #	Description
84297	1m Mini DisplayPort to DisplayPort Adapter Cable M/M - White
84298	2m Mini DisplayPort to DisplayPort Adapter Cable M/M - White
84299	3m Mini DisplayPort to DisplayPort Adapter Cable M/M - White
84300	1m Mini DisplayPort to DisplayPort Adapter Cable M/M - Black
84301	2m Mini DisplayPort to DisplayPort Adapter Cable M/M - Black
84302	3m Mini DisplayPort to DisplayPort Adapter Cable M/M - Black

84300



84334



MINI DISPLAYPORT™ MALE TO SINGLE LINK DVI-D MALE ADAPTER CABLE

Connect the Mini DisplayPort or Thunderbolt™ output of a computer to the DVI input of a computer monitor

This adapter cable is an ideal solution for connecting the Mini DisplayPort or Thunderbolt™ output of a small laptop or tablet to a computer monitor which accepts a DVI-D input. This cable carries a digital video signal, supports up to a 1920x1200 resolution and meets the requirements of high performance applications.

Item #	Description
84334	1m Mini DisplayPort Male to Single Link DVI-D Male Adapter Cable - Black
84335	2m Mini DisplayPort Male to Single Link DVI-D Male Adapter Cable - Black
84336	3m Mini DisplayPort Male to Single Link DVI-D Male Adapter Cable - Black
84337	1m Mini DisplayPort Male to Single Link DVI-D Male Adapter Cable - White
84338	2m Mini DisplayPort Male to Single Link DVI-D Male Adapter Cable - White
84339	3m Mini DisplayPort Male to Single Link DVI-D Male Adapter Cable - White

84337



84410



MINI DISPLAYPORT™ CABLE M/M

Connect the DisplayPort output of a computer to the HDMI input of a HDTV or projector

This adapter cable is an ideal solution for connecting the DisplayPort output of a laptop to a HDTV or projector which accepts a HDMI input. This cable carries a digital audio/video signal, supports up to a 1080p resolution and meets the requirements of high performance applications.

Item #	Description
84410	1m Mini DisplayPort Cable M/M - White
84411	2m Mini DisplayPort Cable M/M - White
84412	3m Mini DisplayPort Cable M/M - White

84413



MINI DISPLAYPORT™ EXTENSION CABLE M/F

Extend a Mini DisplayPort cable and support a digital audio/video connection

This extension cable is an ideal solution for adding length to an existing Mini DisplayPort cable or extending the fixed Mini DisplayPort cable of a computer monitor. This cable carries a digital audio/video signal. Built to DisplayPort 1.2 standards, this cable meets the requirements of high performance applications.

Item #	Description
84413	1m Mini DisplayPort Ext. Cable M/F - White
84414	2m Mini DisplayPort Ext. Cable M/F - White
84415	3m Mini DisplayPort Ext. Cable M/F - White

DISPLAYPORT CABLES & ADAPTERS

84321



DISPLAYPORT™ ADAPTER CONVERTERS

Adapt the DisplayPort output of a computer so that it may be connected to a display or projector which doesn't have a DisplayPort connection

These adapter converters are an ideal solution for converting the DisplayPort output of a laptop so that it may be connected to a display or projector which doesn't have a DisplayPort input. These adapter converters support up to a 1920x1200 resolution (1080p with the HDMI adapter) and meets the requirements of high performance applications.

84322



84323



Item #	Description
84321	20cm DisplayPort Male to Single Link DVI-D Female Adapter Converter - Black
84322	20cm DisplayPort Male to HDMI Female Adapter Converter - Black
84323	20cm DisplayPort Male to VGA Female Adapter Converter - Black

84311



84313



84315



MINI DISPLAYPORT™ MALE TO SINGLE LINK DVI-D FEMALE ADAPTER CONVERTER

Adapt the Mini DisplayPort or Thunderbolt™ output of a computer so that it may be connected to a computer monitor which accepts a DVI-D input

This adapter converter is an ideal solution for adapting the Mini DisplayPort or Thunderbolt™ output of a small laptop or tablet so that it may be connected to a monitor which accepts a DVHD input. This adapter converter carries a digital video signal, supports up to a 1920x1200 resolution and meets the requirements of high performance applications.

MINI DISPLAYPORT™ MALE TO HDMI® FEMALE ADAPTER CONVERTER

Adapt the Mini DisplayPort or Thunderbolt™ output of a computer so that it may be connected to a HDTV or projector which accepts a HDMI input

This adapter converter is an ideal solution for adapting the Mini DisplayPort or Thunderbolt™ output of a small laptop or tablet so that it may be connected to a HDTV or projector which accepts a HDMI input. This adapter converter carries a digital audio/video signal, supports up to a 1080p resolution and meets the requirements of high performance applications.

MINI DISPLAYPORT™ MALE TO VGA FEMALE ADAPTER CONVERTER

Adapt the Mini DisplayPort or Thunderbolt™ output of a computer so that it may be connected to a computer monitor which accepts a VGA input

This adapter converter is an ideal solution for adapting the Mini DisplayPort or Thunderbolt™ output of a small laptop or tablet so that it may be connected to a monitor which accepts a DVHD input. This adapter converter carries a digital video signal, supports up to a 1920x1200 resolution and meets the requirements of high performance applications.

Item #	Description
84311	20cm Mini DisplayPort Male to Single Link DVI-D Female Adapter Converter - Black
84312	20cm Mini DisplayPort Male to Single Link DVI-D Female Adapter Converter - White

Item #	Description
84313	20cm Mini DisplayPort Male to HDMI Female Adapter Converter - Black
84314	20cm Mini DisplayPort Male to HDMI Female Adapter Converter - White

Item #	Description
84315	20cm Mini DisplayPort Male to VGA Female Adapter Converter - Black
84316	20cm Mini DisplayPort Male to VGA Female Adapter Converter - White

NOW AVAILABLE

ACTIVE HDMI HIGH SPEED CABLES

- SUPPORTS 1080P RESOLUTION AT 60HZ
- CEC, EDID & HDCP COMPATIBLE
- REDMERE® TECHNOLOGY

See Page 26

80294



VELOCITY™ 3.5MM M/M STEREO AUDIO CABLE

Connect the 3.5mm jack from any mini-stereo audio device to another audio device

Specifically designed to provide quality music transfer from your desktop PC sound card, portable CD player, MP3 player, iPod®, or any mini-stereo audio device to another audio device.

80283



VELOCITY™ 3.5MM M/F STEREO AUDIO EXTENSION CABLE

Extend the 3.5mm connection from any mini-stereo audio device to another audio device

Specifically designed to extend the connection from your desktop PC sound card, portable CD player, MP3 player, iPod®, or any mini-stereo audio device to another audio device.

Item #	Description
80294	0.5m Velocity 3.5mm M/M Stereo Audio Cable
80295	1m Velocity 3.5mm M/M Stereo Audio Cable
80296	2m Velocity 3.5mm M/M Stereo Audio Cable
80297	3m Velocity 3.5mm M/M Stereo Audio Cable
80298	5m Velocity 3.5mm M/M Stereo Audio Cable
80299	7m Velocity 3.5mm M/M Stereo Audio Cable
80300	10m Velocity 3.5mm M/M Stereo Audio Cable
80301	15m Velocity 3.5mm M/M Stereo Audio Cable

80283	0.5m Velocity 3.5mm M/F Stereo Audio Ext Cable
80284	1m Velocity 3.5mm M/F Stereo Audio Ext Cable
80285	2m Velocity 3.5mm M/F Stereo Audio Ext Cable
80286	3m Velocity 3.5mm M/F Stereo Audio Ext Cable
80287	5m Velocity 3.5mm M/F Stereo Audio Ext Cable
80288	7m Velocity 3.5mm M/F Stereo Audio Ext Cable
80289	10m Velocity 3.5mm M/F Stereo Audio Ext Cable
80290	15m Velocity 3.5mm M/F Stereo Audio Ext Cable

80116



3.5MM M/M STEREO AUDIO CABLE

Attaches to 3.5mm jacks on a variety of audio devices to other audio devices

The 3.5mm stereo audio cable is specifically designed for quality computer audio applications. It attaches a PC sound card, portable CD player, or any mini-stereo audio device with 3.5mm jacks to a multimedia speaker.

80092



3.5MM M/F STEREO AUDIO EXTENSION CABLE

Extend the distance between your 3.5mm stereo audio devices

Extend the distance between stereo audio devices using the 3.5mm connection, such as CD players, stereos, speakers, desktop PC/TV tuners, and other audio devices.

Item #	Description
80116	1m 3.5mm M/M Stereo Audio Cable
80117	2m 3.5mm M/M Stereo Audio Cable
80118	3m 3.5mm M/M Stereo Audio Cable
80119	5m 3.5mm M/M Stereo Audio Cable
80120	7m 3.5mm M/M Stereo Audio Cable
80121	10m 3.5mm M/M Stereo Audio Cable

80092	2m 3.5mm M/F Stereo Audio Ext Cable
80093	3m 3.5mm M/F Stereo Audio Ext Cable
80094	5m 3.5mm M/F Stereo Audio Ext Cable
80095	7m 3.5mm M/F Stereo Audio Ext Cable
80096	10m 3.5mm M/F Stereo Audio Ext Cable

80108



3.5MM M/M STEREO AUDIO CABLE (PC-99 COLOUR-CODED)

Attach the 3.5mm jack from audio devices to a multimedia speaker

Specifically designed for quality computer audio applications. This cable attaches the PC sound card, portable CD player, or any mini-stereo audio device with 3.5mm jacks to a multimedia speaker.

80100



3.5MM M/F STEREO AUDIO EXT. CABLE (PC-99 COLOUR-CODED)

Extend the reach of your existing 3.5mm audio cable

Specifically designed for quality computer audio applications. This cable extends the attachment from the PC sound card, portable CD player, or any mini-stereo audio device with 3.5mm jacks to a multimedia speaker.

Item #	Description
80108	2m 3.5mm M/M Stereo Audio Cable PC-99
80109	3m 3.5mm M/M Stereo Audio Cable PC-99
80110	5m 3.5mm M/M Stereo Audio Cable PC-99
80111	7m 3.5mm M/M Stereo Audio Cable PC-99
80112	10m 3.5mm M/M Stereo Audio Cable PC-99

80100	2m 3.5mm M/F Stereo Audio Cable PC-99
80101	3m 3.5mm M/F Stereo Audio Cable PC-99
80102	5m 3.5mm M/F Stereo Audio Cable PC-99
80103	7m 3.5mm M/F Stereo Audio Cable PC-99
80104	10m 3.5mm M/F Stereo Audio Cable PC-99

80122



3.5MM RIGHT-ANGLED STEREO AUDIO CABLE

Connect to 3.5mm jacks on CD players, stereos, speakers, PC/TV tuners, and other audio devices

The "Value Series" 3.5mm Stereo 90° Right-Angled Audio Cable is specifically designed to provide a brilliant audio experience. It connects a PC sound card, portable CD player, or any mini-stereo audio device with 3.5mm jacks to a multimedia speaker.

Item #	Description
80122	0.5m 3.5mm M/M Right-Angled Stereo Cable
80123	1m 3.5mm M/M Right-Angled Stereo Cable
80124	2m 3.5mm M/M Right-Angled Stereo Cable
80129	3m 3.5mm M/M Right-Angled Stereo Cable
80130	5m 3.5mm M/M Right-Angled Stereo Cable

80137



VALUE SERIES™ ONE 3.5MM STEREO MALE TO TWO 3.5MM STEREO FEMALE Y CABLE

Item #	Description
80137	0.15m 3.5mm Male to (2) Female Y Cable

Converts a 3.5mm jack to dual 3.5mm jacks

Our audio Y adapter cable splits an audio signal or adapts from one connection to another to meet your application needs. This cost effective cable is quality-made to deliver crisp, clear sound for less. Brass/nickel-plated plugs connect to 26AWG spiral-wrapped copper-shielded wire. The dual conductor is shielded to protect against EMI/RFI interference. The connectors are fully snagless to provide excellent strain relief for durable use.

80114



4-PIN 3.5MM MALE TO DUAL 3.5MM FEMALE ADAPTER

Item #	Description
80114	0.15m 4-pin 3.5mm M to Dual 3.5mm F Cable

Connect a separate set of headphones and a microphone to a single 4-pin 3.5mm port

The 15cm 4-pin 3.5mm Male to Dual 3.5mm Female Adapter is the perfect solution for connecting a set of headphones and a microphone to a single 4-pin 3.5mm port on a laptop, tablet, mobile phone, or other mobile device. Newer laptops, mobile phones, and other mobile devices only offer a single 4-pin 3.5mm audio port capable of supporting both an audio input and an audio output. This adapter provides two separate 3.5mm ports that will support a mono microphone and a set of stereo headphones, or a set of external speakers. The compact design of this adapter makes it easy to carry in a laptop bag or briefcase.

80272



VELOCITY™ ONE 3.5MM STEREO MALE TO TWO RCA MALE Y CABLE

Connect the 3.5mm jack from an iPod®, portable CD player, MP3 player, desktop PC sound card, or any mini-stereo audio device to a full-size audio component

Specifically designed to provide quality music transfer from your desktop PC sound card, portable CD player, MP3 player, iPod®, or any mini-stereo audio device to another audio device with RCA audio jacks.

Item #	Description
80272	.5m 3.5mm Stereo M to (2) RCA M Y Cable
80273	1m 3.5mm Stereo M to (2) RCA M Y Cable
80274	2m 3.5mm Stereo M to (2) RCA M Y Cable
80275	3m 3.5mm Stereo M to (2) RCA M Y Cable
80276	5m 3.5mm Stereo M to (2) RCA M Y Cable
80277	7m 3.5mm Stereo M to (2) RCA M Y Cable
80278	10m 3.5mm Stereo M to (2) RCA M Y Cable
80279	15m 3.5mm Stereo M to (2) RCA M Y Cable

80125



ONE 3.5MM MALE TO TWO RCA MALE AUDIO Y CABLE – WHITE

Attach a personal portable or other device with 3.5mm jacks to a full-size component

Our 3.5mm stereo to RCA stereo audio cable is specifically designed to provide quality music transfer. With this cable you can attach a PC sound card, portable CD player, MP3 player, iPod®, or any mini-stereo audio device with 3.5mm jacks to other audio devices with RCA audio jacks.

Item #	Description
80125	1m 3.5mm Male to RCA Male Y Cable - White
80126	2m 3.5mm Male to RCA Male Y Cable - White
80127	3m 3.5mm Male to RCA Male Y Cable - White
80128	5m 3.5mm Male to RCA Male Y Cable - White

80132



VALUE SERIES™ ONE 3.5MM STEREO TO TWO RCA STEREO Y CABLES

Converts a 3.5mm stereo plug to RCA stereo plugs

These cost effective audio Y cables are an ideal solution for adapting your audio connections to meet your application needs. The dual conductors are shielded (26AWG, spiral-wrapped copper-shielded wire), which provides protection against EMI/RFI.

Item #	Description
80132	0.15m 3.5mm Stereo Male to 2 RCA Male Y Cable
80133	2m 3.5mm Stereo Male to 2 RCA Male Y Cable
80134	0.15m 3.5mm Stereo Female to 2 RCA Male Y Cable
80135	0.15m 3.5mm Stereo Male to 2 RCA Female Y Cable
80136	2m 3.5mm Stereo Male to 2 RCA Female Y Cable

80456

80463

80469



PREMIUM AUDIO ADAPTERS

High performance connectors for your demanding audio installations

Ideal for home and mobile audio projects, these premium connectors from C2G are CAD-engineered and precision-machined with 24K gold plating to ensure ideal signal reproduction.

Item #	Description
80456	2.5mm Mono Male to 3.5mm Stereo Female
80457	2.5mm Stereo Male to 3.5mm Stereo Female
80458	3.5mm Mono Male to 3.5mm Stereo Female
80459	3.5mm Mono Male to RCA Female
80460	3.5mm Mono Male to RCA Female
80461	3.5mm Stereo Male to 6.3mm Mono Female
80462	3.5mm Stereo Male to 6.3mm Stereo Female
80463	3.5mm Stereo Male to RCA Female
80464	6.3mm Stereo Male to 3.5mm Mono Female
80465	6.3mm Stereo Male to 3.5mm Stereo Female
80466	6.3mm Stereo Male to RCA Female
80467	3.5mm Stereo Male to Dual 3.5mm Stereo
80468	3.5mm Stereo Male to Dual 6.3mm Stereo
80469	6.3mm Stereo Male to Dual 3.5mm Stereo
80470	6.3mm Stereo Male to Dual 6.3mm Stereo
80471	3.5mm Stereo Male to Dual RCA Female

80472



RCA STEREO AUDIO F/F COUPLER

Couples dual stereo RCA interconnects together for a longer overall length

Couples two RCA plugs to two RCA plugs. Ideal when you need to connect two RCA stereo patch cables together to extend length. Colour-coded for cable identification.

Item #	Description
80472	Stereo Audio Coupler

80317



VELOCITY™ ONE RCA MONO MALE TO TWO RCA STEREO FEMALE Y CABLE-15CM

Connect mono audio to stereo audio equipment with dual RCA connectors

This Velocity Y cable delivers excellent sound quality for today's audio applications. Twisted pair, oxygen-free copper wire and foam dielectric reduce distortion to optimise audio clarity. The low loss 100% spiral-wound oxygen-free copper shielding offers protection against noise and interference.

Item #	Description
80317	RCA Male to (2) Female Y Cable
80318	RCA Female to (2) Male Y Cable

80138



VALUE SERIES™ ONE RCA MONO FEMALE TO TWO RCA STEREO MALE Y CABLE

Convert the signal from dual RCA jacks (stereo) to a single RCA jack (mono)

This cost effective, high quality cable is superior to most standard audio cables and provides a crisp, clear sound. The dual conductor is 26AWG 90% spiral-wrapped copper-shielded wire to shield against EMI/RFI interference.

Item #	Description
80138	0.15m RCA Female to (2) RCA Male Y Cable
80139	0.15m RCA Male to (2) RCA Female Y Cable
80140	0.15m RCA Male to (2) RCA Male Y Cable
80476	RCA Male to (2) RCA Female Adapter

80210



VELOCITY™ RCA STEREO AUDIO CABLE

Excellent sound quality, period

Don't let your interconnects be the weak link in your audio system chain. This audio cable offers excellent sound quality because its bonded construction design delivers a neat, easy connection of audio signals. Twisted pair, oxygen-free copper wire and foamed PE dielectric are optimised for audio signal transmission.

Item #	Description
80210	0.5m RCA Audio Cable
80211	1m RCA Audio Cable
80212	2m RCA Audio Cable
80213	3m RCA Audio Cable
80214	5m RCA Audio Cable

80232



VELOCITY™ BASS MANAGEMENT SUBWOOFER CABLE

Get the most from your powered subwoofer investment. Make the right choice to transport the foundation of your music and cinema experience.

A cable whose job is to transmit just two or three octaves of audio information. This subwoofer cable offers superb impact and detail while maintaining a "tough as nails" built quality.

Item #	Description
80232	3m Bass Management Subwoofer Cable
80233	5m Bass Management Subwoofer Cable
80234	7m Bass Management Subwoofer Cable
80235	10m Bass Management Subwoofer Cable

80449



STEREO AUDIO ISOLATION TRANSFORMER

Stop speaker hum due to the effects of ground loops; an easy connection via standard audio cables

Every installation technician has faced it or soon will—the dreaded humming from the speakers, a telltale sign of a ground loop. Ground loops occur when multiple audio/video components are powered from different outlets, most commonly, outlets that are tied to different circuitbreakers or even a different secondary from the power transformer. Ground loops manifest themselves in the form of speaker hum.

Our isolation transformer easily connects into your audio/video system and breaks the ground path through cables between components. Start at the component last installed before the ground loop was discovered, and connect the isolation transformer at different ends of the audio/video cable until the ground loop is gone. Gold-plated 3.5mm stereo jacks.

Item #	Description
80449	Stereo Audio Isolation Transformer

80262



VELOCITY™ S/PDIF DIGITAL AUDIO COAX CABLE

Carries digital audio from a CD transport, DVD player, DAT deck, or other digital component to an A/V receiver digital input

The Velocity digital audio cable is a great upgrade to the cables typically included with consumer electronics products. The low loss 75Ohm oxygen-free copper centre conductors and foam dielectric provide high quality digital sound and performance.

Item #	Description
80262	0.5m Velocity S/PDIF Digital Coax Audio Cable
80263	1m Velocity S/PDIF Digital Coax Audio Cable
80264	2m Velocity S/PDIF Digital Coax Audio Cable
80265	3m Velocity S/PDIF Digital Coax Audio Cable
80268	10m Velocity S/PDIF Digital Coax Audio Cable

80322



VELOCITY™ TOSLINK® OPTICAL DIGITAL CABLE

Optical digital audio is an excellent interface for stereo audio or multi-channel surround sound from CD and DVD players, satellite receivers, and gaming systems

Optical digital cables use light to transfer the signal; thus completely eliminating any chance for RFI, EMI, or ground loop interference.

Item #	Description
80322	0.5 m TOSLINK Optical Digital Cable
80323	1m TOSLINK Optical Digital Cable
80324	2m TOSLINK Optical Digital Cable
80325	3m TOSLINK Optical Digital Cable
80326	5m TOSLINK Optical Digital Cable

80327



VELOCITY™ 90° ANGLE TOSLINK® PORT SAVER ADAPTER

Angled for easier installation to connect cables in tight spaces while enabling less strain on the connector

Stop struggling with TOSLINK cables being too close to the wall or the back of your cabinet. Our right angle adapter aids in connecting cables in tight and congested spaces. It enables you to correctly orient your cable so less strain occurs on the connector.

Item #	Description
80327	Velocity 90° Angle TOSLINK Port Saver Adapter

80454



VELOCITY™ 90° ANGLE TOSLINK® TO MINI PLUG ADAPTER

Angled for easier installation to connect cables in tight spaces while enabling less strain on the connector

Stop struggling with Mini Plug connections being too close to the wall or the back of your cabinet. Our 90° adapter aids in connecting cables in tight and congested spaces. It enables you to correctly orient your cable so less strain occurs on the connector.

Item #	Description
80454	Velocity 90° Angle TOSLINK to Mini Plug Adapter

80453



TOSLINK® DIGITAL AUDIO SPLITTER

Split the digital audio signal to both your receiver and your recorder

Split the digital audio signal from your CD or DVD player or other digital device, and connect to both your receiver and recorder.

Please Note: This splitter is not designed to connect two sources (DVD player, cable box, game system) to one destination (television, home theatre receiver). Instead, it is only designed to take one source and split the signal to two destinations.

Item #	Description
80453	TOSLINK Digital Audio Splitter

80376



PRO-AUDIO XLR MALE TO XLR FEMALE CABLE

Connect line or mic level outputs from mixing consoles to recorders and amplifiers with balanced inputs

Use this XLR to XLR cable to connect unbalanced sources to balanced XLR inputs. This pro-audio cable is made from 22AWG twisted pair audio cable under an aluminum foil shield and 60% copper braid for maximum shielding from noise.

Item #	Description
80376	0.5m Pro-Audio XLR Male to Female Cable
80377	1m Pro-Audio XLR Male to Female Cable
80378	2m Pro-Audio XLR Male to Female Cable
80379	3m Pro-Audio XLR Male to Female Cable
80380	5m Pro-Audio XLR Male to Female Cable
80381	7m Pro-Audio XLR Male to Female Cable
80382	10m Pro-Audio XLR Male to Female Cable
80383	15m Pro-Audio XLR Male to Female Cable

80387



PRO-AUDIO 1/4 INCH TRS MALE TO 1/4 INCH TRS MALE CABLE

Connect line or mic level outputs from mixing consoles to recorders and amplifiers with balanced inputs

Use this Tip/Ring/Sleeve (TRS) configuration cable to connect balanced line outputs to balanced line inputs. This pro-audio cable is made from 22AWG twisted pair audio cable under an aluminum foil shield and 60% copper braid for maximum shielding from noise.

Item #	Description
80387	0.5m Pro-Audio 1/4 inch Male to Male Cable
80388	1m Pro-Audio 1/4 inch Male to Male Cable
80389	2m Pro-Audio 1/4 inch Male to Male Cable
80390	3m Pro-Audio 1/4 inch Male to Male Cable
80391	5m Pro-Audio 1/4 inch Male to Male Cable
80392	7m Pro-Audio 1/4 inch Male to Male Cable
80393	10m Pro-Audio 1/4 inch Male to Male Cable
80394	15m Pro-Audio 1/4 inch Male to Male Cable

80529



18AWG BULK SPEAKER WIRE - 50FT

Ideal for connecting speakers to audio amplifiers

This cost-effective wire provides maximum sound for your pound. Clear PVC jacket with white marker enables easy polarity identification. The high strand count offers maximum flexibility for easier installations.

Item #	Description
80529	18 AWG Bulk Speaker Wire - 50ft

DISPLAYPORT AND MINI DISPLAYPORT SOLUTIONS

ATTACH.
ADAPT.
CONVERT.



DIGITAL A/V CONVERGENCE

DisplayPort and Mini DisplayPort are growing at an exponential rate. The small form factor of these connectors lends itself to being used on small platform laptops. Laptops are replaced at a more frequent rate than monitors and displays. Because of this, there will be situations where the DisplayPort or Mini DisplayPort output of the new computer must be connected to the HDMI, DVI-D, or VGA input of a legacy display, which is driving the market need for these adapters.

Configuration Solutions:

- DisplayPort to VGA
- DisplayPort to HDMI
- DisplayPort to DVI-D
- DisplayPort to Mini DisplayPort
- Mini DisplayPort to VGA
- Mini DisplayPort to HDMI
- Mini DisplayPort to DVI-D
- Mini DisplayPort to DisplayPort



80452



750HM RCA VIDEO COUPLER

Connect two composite video cables to extend the connection

This video coupler offers excellent picture quality for today's video and home theatre applications. It is constructed with 24K gold plating that resists deterioration, and provides maximum corrosion resistance for low loss signal transfer. This coupler provides cable-matched 75Ohm impedance to deliver an accurate picture, resolution and colour. Yellow-coded for quick identification. Quickly connect two composite video cables to extend the overall length.

Item #	Description
80452	750hm RCA Video Coupler

80251



VELOCITY™ COMPONENT VIDEO + RCA STEREO AUDIO CABLE

Efficiently use one cable to attach component video and stereo audio

The Velocity Component Video with Stereo Audio Cable provides improved picture and sound quality when compared to ordinary "out of the box" cables. Low loss 75Ohm oxygen-free copper centre conductors and foam dielectric deliver exceptional video detail, colour, and brightness.

Item #	Description
80251	0.5m Component Video + RCA Audio Stereo Cable
80252	1m Component Video + RCA Audio Stereo Cable
80253	2m Component Video + RCA Audio Stereo Cable



80474

COMPOSITE STEREO A/V F/F AND COMPONENT VIDEO F/F COUPLERS

Couple two interconnects together for a longer overall length

Couples three RCA plugs to three RCA plugs to help you connect two RCA component video patch cables or two composite A/V patch cables together to extend the overall length. Colour-coded for cable identification.

Item #	Description
80474	Component Video Coupler
80473	Stereo Audio/Video Coupler

80473



80364



750HM BNC CABLE

Delivers the high quality you expect for broadcast, studio, surveillance, and home theatre video

A high quality BNC cable for video applications including CCTV, broadcast, studio, boardroom presentations, home theatre, etc. Manufactured from 75Ohm RG59/U dual shield coax cable (60% copper braid over foil) with a 22AWG copper-covered steel centre conductor. Finished with bright, nickel-plated BNC connectors that have snagless PVC strain relief to protect the cable from wear over time.

Item #	Description
80364	0.5m 75Ohm BNC Cable
80365	1m 75Ohm BNC Cable
80366	2m 75Ohm BNC Cable
80367	3m 75Ohm BNC Cable
80368	5m 75Ohm BNC Cable
80369	7m 75Ohm BNC Cable
80370	10m 75Ohm BNC Cable
80371	15m 75Ohm BNC Cable

80410



RCA FEMALE TO BNC MALE VIDEO ADAPTER

Changes a cable with a male RCA connector into a male BNC connector

If you have an RCA cable already, this adapter will allow it to be used with video gear with a BNC input. You can also use this adapter directly with the BNC port of a quad-screen sequencer or video monitor so that a cable with RCA connectors can be easily used.

Item #	Description
80410	RCA Female to BNC Male Adapter

80444



BI-DIRECTIONAL S-VIDEO FEMALE TO RCA MALE VIDEO ADAPTER

A low cost way to convert composite video to s-video or vice versa

A low cost alternative to high priced active converters. Use this to connect the male end of an s-video cable to the female end of an RCA composite video cable. The Y/C signal separation circuitry provides a bright, crisp picture from a DVD player, VCD, laser disc, VCR, camcorder, cable/DSS receiver, or multimedia PC to an A/V receiver, television, or monitor. Gold terminals ensure long-lasting, corrosion-free connections. Passive construction; no power adapters are required.

Item #	Description
80444	BIDI RCA Male S-Video Female Video Adapter
80445	BIDI S-Video Male RCA Female Video Adapter

89050



HDMI® AUTO SWITCHES

Conveniently switches between HDMI devices and supports a 1080p resolution

Perfect for situations where two or three HDMI devices must share a single HDMI input on a display, this HDMI auto switch provides for hassle free operation. The power required for operation of this switch is provided from the HDMI source devices, so no separate power adapter is required*. With most devices now using HDMI, it is easy to run out of free HDMI inputs on a HDTV or home theater receiver.

Please note: Most HDMI source devices are able to provide the necessary power for the operation of the HDMI switch; however, in some situations the power supply of the HDMI source device is insufficient and additional power is required.

Item #	Description
89050	2-Port HDMI Auto Switch
89051	3-Port HDMI Auto Switch

89036



2-PORT AND 4-PORT HDMI® SPLITTERS

Split a single HDMI audio/video signal from a source device to two or four HD displays

The 2-Port and 4-Port HDMI Splitter is the perfect solution for connecting a Blu-ray™ player, HDTV receiver, DVD player, or other audio/video device to four HDMI displays. These splitters support HDMI features including 4K resolution, 1080p, 3D, Deep Colour, x.v. colour™, high speed refresh rates, and lossless multi-channel surround sound. They are HDCP-compliant for full playback of high definition content. These splitters are designed to support 480i, 480p, 720p, 1080i, 1080p, and 4K resolutions. The splitters are cascadable up to three layers to distribute the source signal to as many as 64 displays.

Item #	Description
89036	2-Port HDMI Splitter, 3D
89023	4-Port HDMI Splitter, 3D

89035



4-PORT HDMI® SELECTOR SWITCH

1080p and HDCP™ compatible; provides convenient switching from multiple HDMI inputs

Most high definition A/V components utilise the HDMI interface to provide crystal clear, digital sound and picture. With the wealth of devices now using HDMI, it's easy to run out of free HDMI inputs on your TV set or receiver. Our 4-port HDMI Selector Switch solves this problem by providing additional high definition digital inputs for sources including DVD player, Blu-ray™, Disc and HD-DVD players, gaming systems, and high definition cable/satellite boxes. This device is also compatible with most HDMI 3D devices, allowing you to switch between 3D devices on your 3D display.

Item #	Description
89035	4-Port HDMI Selector Switch, 3D

89030



DVI-D SPLITTER WITH HDCP™

Split one DVI-D output for display on two DVI-D compatible monitors

The DVI-D Splitter connects two HDTV displays or two computer monitors equipped with DVI inputs. HDCP compatibility means this splitter will work with high definition video for HDTV applications and high resolution PC applications. Compatible with DVI-D equipped PC video cards operating at a maximum resolution of 1920x1080 pixels, or with video devices at 480p, 480i, 720p, 1080i, and 1080p scan rates. Built-in DVI repeater allows lossless runs up to 10 metres from the splitter.

Item #	Description
89030	2-Port DVI Splitter/Extender with HDCP

89012



2/4/8-PORT UXGA MONITOR SPLITTERS/EXTENDERS (MALE INPUT)

Split your VGA signal from two to eight outputs

UXGA Splitters/Extenders (also known as VGA video splitters) are a robust hardware solution that can distribute any video signal from 2 to 8 different video outputs, depending on the splitter used, while maintaining brilliant picture quality. Though powerful, these splitters are easy to use; just attach the cables, and you're ready to go. There is no software required, or complicated interface cards to install. These monitor splitters not only distribute, but also boost your high resolution video signal up to 65 metres.

Includes power-saving mode, colour-coded connectors for the input and outputs, and activity LED indicators. Cascade multiple units together for even more outputs.

Item #	Description
89012	UXGA Video Splitter/Extender 2-Port
89013	UXGA Video Splitter/Extender 4-Port
89014	UXGA Video Splitter/Extender 8-Port

89025



2/4-PORT UXGA MONITOR SPLITTERS/EXTENDERS WITH 3.5MM AUDIO

Split your video and audio signal from two to four outputs—up to 64 metres

Monitor Splitters/Extenders with Audio are a brilliant choice for distributing audio and video to classrooms, exhibits, tradeshows, demonstrations, and multimedia presentations. These monitor splitters broadcast your computer's audio and video output from two to four different video outputs, depending on the splitter/extender used. Daisy-chain more than one splitter to expand the number of monitors and speakers you can reach. With the built-in video signal enhancement, you can place monitors up to 64 metres away while maintaining your video quality..

Item #	Description
89025	2-Port SVGA Splitter/Extender + 3.5mm Audio
89031	4-Port SVGA Splitter/Extender + 3.5mm Audio

89032



2-PORT UXGA MONITOR SPLITTER

Compact USB-powered splitter cable extends signal up to 64 metres

The 2-Port Monitor Splitter is an excellent solution for distributing video across two displays. Create a simple digital signage application or use in a conference room or classroom to broadcast computer content to multiple displays. With integrated video signal enhancement, displays can be placed up to 64 metres from the source without sacrificing video quality. This provides complete flexibility while ensuring the highest quality resolution. Multiple splitters can be added to expand the number of displays and distance. This splitter's compact cable design makes it easy to use in tight spaces or when traveling. No drivers or additional software are required, making it easy to use.

Item #	Description
89032	Compact 2-Port VGA Splitter

89033



2-PORT UXGA + 3.5MM MONITOR SPLITTER

Compact USB powered splitter cable extends signal up to 64 metres

The 2-Port Monitor Splitter is an excellent solution for distributing video across two displays. Create a simple digital signage application or use in a conference room or classroom to broadcast computer content to multiple displays. With integrated video signal enhancement, displays can be placed up to 64 metres from the source without sacrificing video quality. This provides complete flexibility while ensuring the highest quality resolution. Multiple splitters can be added to expand the number of displays and distance. This splitter's compact cable design makes it easy to use in tight spaces or when traveling. No drivers or additional software are required, making it easy to use.

Item #	Description
89033	Compact 2-Port VGA Splitter + 3.5mm Audio

89044



SHORT RANGE HDMI® OVER CAT5 EXTENDER KIT WITH AUTO EQUALISATION

Extend HDMI video and audio up to 50 metres over two Cat5 patch cables

The Short Range HDMI over Cat5 Extender kit is an ideal solution for extending HDMI audio/video signals beyond the typical 15m length limitation of a HDMI cable. This solution is able to extend HDMI up to 50m and requires the use of two Cat5 patch cables. Auto equalisation makes installation easy regardless of the length of the Cat5 patch cables used. Simply make the HDMI and Cat5 cable connections and the transmitter and receiver will automatically adjust to optimize the video for the length of cable used. EDID pass through is supported to ensure that content is sent at the optimal resolution for the display. HDCP is supported, allowing protected content to be passed through this extension solution. The maximum resolution supported will vary depending upon the type and length of the Cat5 patch cable.

Item #	Description
89044	Short Range HDMI over Cat5 Extender Kit with Auto Equalisation

89365



HDMI® OVER CAT5 BOX EXTENDERS

Extend an HDMI signal up to 100m at 1080p with no signal degradation

The HDMI over Cat5 products allow for the extension of an HDMI signal over solid conductor Cat5e/6 twisted pair cable up to 100m without signal degradation at a 1080p video resolution. This solution is compatible with any operating system and is truly plug and play, with no drivers or software required. In addition, this solution utilises TruChoice™ Power which provides the flexibility to power the system with a single power supply at either the transmitter or receiver end. HDBaseT technology allows the Extended Display Identification Data (EDID) signals, i.e. communication of the display's capabilities, to pass through the extension solution, ensuring that the content from the source is sent at the optimal resolution for the display.

Item #	Description
89365	HDMI over Cat5 Box Transmitter
89366	HDMI over Cat5 Box Receiver

89362



VGA OVER CAT5 BOX EXTENDERS

Extend a video signal up to 100m at 1920x1200 resolution

The VGA over Cat5 Box Transmitter, when used in conjunction with a receiver, allows you to extend a VGA signal over a Cat5/Cat5e/Cat6 unshielded twisted pair cable up to 100m without signal degradation at 1920x1200 or 1920x1080 resolutions. This solution is compatible with any operating system and is truly plug and play, with no drivers or software required. The transmitter and receiver come in either wall plate or box form factors and are interoperable allowing you to choose the form factors that are best suited for the application. In addition, this solution utilises TruChoice™ Power providing you the flexibility to power at either the transmitter or receiver end.

Item #	Description
89362	VGA over Cat5 Box Transmitter
89363	VGA over Cat5 Box Receiver
89364	VGA over Cat5 4-Port Box Transmitter

89367



VGA + 3.5 OVER CAT5 BOX EXTENDERS

Extend a video and audio signal up to 100m at 1920x1200 resolution

Item #	Description
89367	VGA + 3.5mm over Cat5 Box Transmitter
89368	VGA + 3.5mm over Cat5 Box Receiver
89369	VGA + 3.5mm over Cat5 4-Port Box Transmitter

The VGA + 3.5mm Audio over Cat5 Box Transmitter, when used in conjunction with a receiver, allows you to extend a VGA signal over two Cat5/Cat5e/Cat6 unshielded twisted pair cables up to 100m without signal degradation at 1920x1200 or 1920x1080 resolutions. This solution is compatible with any operating system and is truly plug and play, with no drivers or software required. The transmitter and receiver come in either wall plate or box form factors and are interoperable allowing you to choose the form factors that are best suited for the application. In addition, this solution utilises TruChoice™ Power providing you the flexibility to power at either the transmitter or receiver end. The EDID copy feature ensures compatibility with any monitor.

89039



VGA TO COMPOSITE/S-VIDEO PC-TV ADAPTER

Convert your PC's VGA signal to composite to allow connection to a TV

Item #	Description
89039	VGA to Composite/S-Video PC-TV Adapter

The PC-TV adapter device allows you to convert your VGA signal from a computer to a composite out video so you can connect your PC, Mac® or other VGA devices to your TV or projector. This is useful when connecting your computer to an older TV or projector (that doesn't support VGA) for large screen viewing.

89024



VGA TO HDMI® CONVERTER

View your PC screen on an HDMI-enabled monitor or TV

Item #	Description
89024	VGA + 3.5mm to HDMI Converter

The VGA to HDMI Converter is the ideal solution for attaching a PC to newer monitors or TVs that do not have an HD15 (VGA) input. With an added 3.5mm audio connection, enjoy high definition video and audio. The converter is simple to use, with no software or drivers required. Simply connect the converter and begin enjoying PC content on your display

81699



HDMI® TO VGA ADAPTER

Ensure compatibility between newer and older A/V equipment

Item #	Description
81699	HDMI to VGA Converter

In order to connect newer laptops or computers that output an HDMI signal to older peripherals that accept a VGA input—such as projectors or monitors—the digital HDMI signal must be converted to an analogue VGA signal. Many products on the market, particularly cables, claim this capability. However, most of these products only "adapt" from HDMI to VGA. Without an active conversion process, there are very few devices that are able to output an analogue VGA signal from an HDMI output.

The HDMI to VGA Converter is an active device which converts a digital HDMI signal to an analogue VGA signal. This product is easy to use, with no software or drivers required.

82401



PRO DIGITAL VIDEO TO VGA CONVERTER

Connect a new device with a digital output to a legacy display with a VGA input

Item #	Description
82400	Pro HDMI to VGA Converter
82401	Pro DVI-D to VGA Converter

The Pro Digital Video to VGA Converter is an ideal solution for connecting newer laptops or computers that output a digital video signal to legacy displays—such as projectors or monitors—which accept a VGA input. This device converts the digital video signal to an analogue VGA video signal. Many products on the market, particularly cables, claim this capability. However, most of these products only "adapt" to VGA. Without an active conversion process, there are very few devices that are able to output an analogue VGA signal from a digital output.

81698



HDMI® TO DISPLAYPORT™ ADAPTER CONVERTER

Connect a device with an HDMI output to a display with a DisplayPort input

The HDMI to DisplayPort Converter is the perfect solution for connecting devices with an HDMI output to a display with a DisplayPort input. The HDMI to DisplayPort Converter provides functionality that is not supported by other adapters that are designed to connect the DisplayPort output of a device and to a display which accepts an HDMI input. The HDMI to DisplayPort Converter supports a maximum resolution of 1920x1200 and supports HDCP.

Item #	Description
81698	HDMI to DisplayPort Adapter Converter

82365



HDMI® INLINE EXTENDER

Couples two HDMI cables and extends HDMI A/V signals up to 82ft

The HDMI In-Line Extender is the perfect solution for extending HDMI A/V signals over HDMI cabling. This extender is capable of supporting a 4K resolution at extension distances up to 50 feet and a 1080p resolution at extension distances up to 82 feet. In most instances, no external power is required*, and the female to female connector configuration makes this device easy to install.

Item #	Description
82365	HDMI In-Line Extender

81638



81930



81932



81637



81931



81933



81636



USB 2.0 TO VGA/HDMI/DVI ADAPTERS

Use an available USB port to expand your computer's video capabilities

The USB 2.0 to VGA/HDMI/DVI Adapters provide the capability to extend your viewing options from a laptop or PC. Enjoy extended, mirrored, or primary display modes and allow content to be shared across multiple displays which increases productivity while minimising additional hardware investments.

Item #	Description
81638	USB 2.0 to VGA Adapter
81637	USB 2.0 to HDMI Adapter
81636	USB 2.0 to DVI Adapter

USB 3.0 TO VGA/DVI/HDMI/ DISPLAYPORT VIDEO ADAPTERS – EXTERNAL VIDEO CARD

Extend a video and audio signal up to 100m at 1920x1200 resolution

The perfect solution for adding duplicate or extended desktop to a computer utilising a USB port. The duplicate feature allows a user to show the same images from the primary display on a secondary display. This is useful in situations where a presentation must be given.

Item #	Description
81930	USB 3.0 to VGA Video Adapter
81931	USB 3.0 to DVI Video Adapter
81932	USB 3.0 to HDMI Video Adapter
81933	USB 3.0 to DisplayPort Video Adapter

89020



INFRARED (IR) REMOTE CONTROL REPEATER KIT

Item #

Description

89020 IR Repeater Kit

Forward infrared signals to operate electronic components behind closed doors

Does your entertainment system have wooden doors, or would you like to mount your components in a closet? Without a clear line of sight, infrared (IR) signals from a remote control will not reach the equipment. We have the answer. Our remote control repeater kit contains all equipment necessary to remotely operate four components (expandable to 12 components) using your standard remotes. With this kit, you may mount a receiver in a convenient place on or near your entertainment system. The receiver's cable is attached to the repeater system that is mounted in your entertainment cabinet.



C2G's "Try Before You Buy" Program

C2G understands the importance of making sure you have selected the right product for the right application. And more significantly, the product has to consistently perform in your environment. With this in mind, C2G offers a complimentary "Try Before You Buy" program. This program allows you to get your hands on a specific C2G product, check it out, put it through its paces and feel absolutely confident that it will meet your needs—all for free. If you're interested in this program, contact your C2G appointed representative and we will promptly get that product to you.

- Complimentary Program
- Test Product in Live Environments
- Build Assurance in Product Performance
- Proof of Concept for Data Centre Projects

PC & MOBILE SOLUTIONS



NEW



EXPANDED RANGE OF USB-C PRODUCTS

USB-C is revolutionising the way we connect and use devices

New and unique, the USB-C is the connector for today and tomorrow.

C2G has simplified connectivity with USB-C, offering the correct products for all of the most common applications. To simplify it further, all of the connectors are clearly marked with the USB version number and colour coded. USB 2.0 is white, USB 3.0 is blue, and USB 3.1 is red—making the adaptation to USB-C less confusing.

From printers to smartphones, tablets to tool and die machines—C2G offers straightforward solutions to applications for all of its customers.



SMALLER SIZE

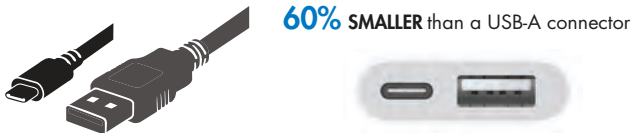

SYMMETRICAL DESIGN



DURABILITY



Check out all of our USB products plus our latest additions on pages 45-52

DATA TRANSFER

DATA TRANSFER RATES up to **10GBIT/S**

2X THE DATA RATE of USB 3.0

20X THE DATA RATE of USB 2.0

Transfer a 4K movie



POWER DELIVERY

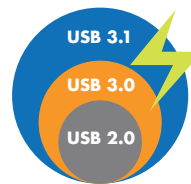

20 VOLTS, 5 AMPS, AND 100 WATTS for device power and charging

Power increase of **20x OVER** USB 3.0 **40x OVER** USB 2.0

Use a single power supply to power a monitor and **CHARGE A LAPTOP** through a **USB 3.1 USB-C CABLE**

AUDIO/VIDEO



Audio/Video is a brand **NEW FEATURE** for USB 3.1

Provides **DISPLAYPORT VIDEO** to a connected monitor

4-CHANNEL AUDIO including **MICROPHONE SUPPORT**

Easily adapt to:

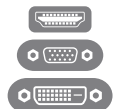

80520



USB-C TO DISPLAYPORT™ ADAPTER CONVERTER

Connect a USB Type-C port to the DisplayPort of a monitor, projector, or HDTV to display video and audio

This USB-C to DisplayPort adapter is ideal for showing presentations, pictures or other audio/video content from the USB-C port of a laptop or tablet to the Displayport input of a monitor, projector, or HDTV. This adapter supports up to a 4K (3840x2160 at 30Hz) resolution, allowing it to deliver a high quality video image to the connected display. The compact design of this adapter makes it a perfect pair for BYOD (Bring Your Own Device) applications in education or corporate environments. Pairing this device with the USB-C to VGA adapter or the USB-C to HDMI adapter provides you with a video port for any situation when your presenting.

Item #	Description
80520	USB-C to Displayport Adapter Converter - White
80521	USB-C to Displayport Adapter Converter - Black

80512



USB 3.1 USB-C TO HDMI AUDIO/VIDEO ADAPTER

Connect a USB Type-C port to the HDMI port of an HDTV or projector to display video and audio

This USB-C to HDMI adapters is an ideal solution for utilizing the audio/video support built in to USB Type-C ports to feed an audio/video signal to a HDMI HDTV or projector to display video. This adapter supports up to a 4K (3840x2160 at 30Hz) resolution allowing it to deliver a high quality video image to the connected display. The compact design of this adapter makes it a perfect pair for BYOD (Bring Your Own Device) applications in education or corporate environments. Pairing this device with the USB-C to VGA adapter or the USB-C to HDMI adapter provides you with a video port for any situation when your presenting.

Item #	Description
80512	USB 3.1 USB-C to HDMI A/V Adapter - Black
80516	USB 3.1 USB-C to HDMI A/V Adapter - White

88842



USB 2.0 USB-C TO DB9 SERIAL RS232 ADAPTER CABLE

Connect a Serial RS232 device to a USB Type-C port

This USB-C to DB9 Serial RS232 adapter is an ideal solution for connecting a Serial RS232 device to a USB Type-C port. The adapter allows point-of-sale terminals, serial modems, industrial equipment, and other serial RS232 peripherals to interface directly with a USB Type-C port. This adapter has a data transfer rate of over 230 kbps and uses no IRQs, so there are no IRQ conflicts. Multiple adapters may be used on a single computer allowing multiple serial devices to be connected simultaneously.

Item #	Description
88842	USB 2.0 USB-C to DB9 Serial RS232 Adapter Cable

89053



USB 3.0 USB-C TO 4-PORT USB-A HUB

Connect up to four USB devices to a single USB Type-C port

The USB-C to 4-Port USB-A Hub expands USB capabilities by providing four USB-A ports for connecting peripherals to a single USB-C port. This hub is ideal for supporting keyboards, mice and other low-powered USB devices. Small, lightweight and portable, the hub is easily stored in a laptop case or pocket. With a transfer rate up to 5Gbps, it is fully USB 3.0 (USB 3.1 Gen 1) compliant, backwards compatible with USB 2.0 and USB 1.1 devices, and supports all USB peripherals, including keyboards and mice, smartphones, tablets, and other USB devices. This hub is compatible with any USB-enabled PC or Mac® and is a plug and play device with no software or drivers required. This hub can be self-powered from the USB-C port, or may be used with the included AC power adapter when connecting power hungry USB devices such as a USB hard drive or USB to video adapter.

Item #	Description
89053	USB 3.0 USB-C to 4-Port USB-A Hub

89052



USB-C TO GIGABIT ETHERNET NETWORK ADAPTER

Add a wired network connection using a USB Type-C port for Internet connectivity

The USB-C to Gigabit Ethernet Network Adapter is an ideal solution for converting an existing USB-C port to a RJ45 Gigabit Ethernet port for a wired network connection to the Internet. This adapter utilizes the high bandwidth of the USB-C port to support true Gigabit Ethernet speeds. This flexible solution requires no external power supply, simply connect the adapter to an available USB-C port, and connect a Cat5 cable from the adapter to an RJ45 Network port. With speeds up to 1000Mbps, file transfer between computers is fast and easy, even with large amounts of multimedia data. The adapter is a great solution for those new computers that do not provide a wired Ethernet port or have a damaged Ethernet port.

Item #	Description
89052	USB-C to Gigabit Ethernet Adapter

88843



USB 3.1 USB-C TO VGA VIDEO ADAPTER

Connect a USB Type-C port to the VGA port of a monitor or projector to display video

This USB-C to VGA adapters is an ideal solution for utilizing the video support built in to USB Type-C ports to feed a video signal to a VGA monitor or projector to display video. This adapter supports up to a 1920x1200 resolution allowing it to deliver a high quality video image to the connected display. The compact design of this adapter makes it a perfect pair for BYOD (Bring Your Own Device) applications in education or corporate environments.

Item #	Description
88843	USB 3.1 USB-C to VGA Video Adapter - Black
88844	USB 3.1 USB-C to HDMI A/V Adapter - White

88858



USB 2.0 USB-C TO USB-B CABLE MALE/MALE - BLACK

Connect a USB-B device to a USB Type-C port on a laptop, desktop computer, tablet, or other device

This USB 2.0 USB-C to USB-B cable is the perfect solution for connecting a printer, hub, or other device that has a USB-B port to a computer, tablet or other device that has a USB Type-C port for USB 2.0 communication. The durable, colour-coded USB Type-C connector allows for up to 10,000 connection cycles. This cable supports a data rate up to 480Mbps for data transfer and sync with 5 volts and 1 amp of power for device operation and charging.

Note: This cable is designed to support USB 2.0 communication and features and is not able to support USB 3.1 Gen 2 Communication and features.

Item #	Description
88858	1m USB 2.0 USB-C to USB-B Cable - Black
88859	2m USB 2.0 USB-C to USB-B Cable - Black
88860	3m USB 2.0 USB-C to USB-B Cable - Black
88861	4m USB 2.0 USB-C to USB-B Cable - Black

88870



USB 2.0 USB-C TO USB-A CABLE MALE/MALE - BLACK

Connect a USB-C device to a USB-A port on a laptop, desktop computer, tablet, or other device

This USB 2.0 USB-A to USB-C cable is the perfect solution for connecting a smartphone, tablet, or another mobile device with a USB-C port to a computer with the standard a USB Type-A port for USB 2.0 communication. The durable, colour-coded USB Type-C connector allows for up to 10,000 connection cycles. This cable supports a data rate up to 480Mbps for data transfer and sync with 5 volts and 1 amp of power for device operation and charging.

Note: This cable is designed to support USB 2.0 communication and features and is not able to support USB 3.1 Gen 2 Communication and features.

Item #	Description
88870	1m USB 2.0 USB-C to USB-A Cable - Black
88871	2m USB 2.0 USB-C to USB-A Cable - Black
88872	3m USB 2.0 USB-C to USB-A Cable - Black
88873	4m USB 2.0 USB-C to USB-A Cable - Black

88869



USB 2.0 USB-C TO USB MICRO-B ADAPTER MALE TO FEMALE - BLACK

Adapt a USB 2.0 USB-C to USB Micro-B cable to connect the USB Type-C port

This USB 2.0 USB-C to USB Micro-B adapter is the perfect solution for adapting an existing USB 2.0 USB-A to USB Micro-B cable for connecting the USB Type-C port of a smartphone, tablet, or other device to a USB-A port on a computer, tablet, or other device for USB 2.0 communication. The durable, colour-coded USB Type-C connector allows for up to 10,000 connection cycles. This cable supports a data rate up to 480Mbps for data transfer and sync with 5 volts and 1 amp of power for device operation and charging.

Note: This cable is designed to support USB 2.0 communication and features and is not able to support USB 3.1 Gen 2 Communication and features.

Item #	Description
88869	USB 2.0 USB-C to USB Micro-B Adapter - Black

88850



USB 2.0 USB-C TO USB MICRO-B CABLE MALE TO MALE - BLACK

Connect a USB Micro-B device to a USB Type-C port on a laptop, desktop computer, tablet, or other device

This USB 2.0 USB-C to USB Micro-B cable is the perfect solution for connecting a smartphone, tablet, or other device that has a USB Micro-B port to a computer, tablet or other device that has a USB Type-C port for USB 2.0 communication. The durable, colour-coded USB Type-C connector allows for up to 10,000 connection cycles. This cable supports a data rate up to 480Mbps for data transfer and sync with 5 volts and 1 amp of power for device operation and charging.

Note: This cable is designed to support USB 2.0 communication and features and is not able to support USB 3.1 Gen 2 Communication and features.

Item #	Description
88850	1m USB 2.0 USB-C to USB Micro-B Cable - Black
88851	2m USB 2.0 USB-C to USB Micro-B Cable - Black
88852	3m USB 2.0 USB-C to USB Micro-B Cable - Black
88853	4m USB 2.0 USB-C to USB Micro-B Cable - Black

88854



USB 2.0 USB-C TO USB MINI-B CABLE MALE TO MALE

Connect a USB Mini-B device to a USB Type-C port on a laptop, desktop computer or tablet

This USB 2.0 USB-C to USB Mini-B cable is the perfect solution for connecting a camera, cellphone, tablet or other device that has a USB Mini-B port to a computer, tablet or other device that has a USB Type-C port for USB 2.0 communication. The durable, colour-coded USB Type-C connector allows for up to 10,000 connection cycles. This cable supports a data rate up to 480Mbps for data transfer and sync with 5 volts and 1 amp of power for device operation and charging.

Note: This cable is designed to support USB 2.0 communication and features and is not able to support USB 3.1 Gen 2 Communication and features.

Item #	Description
88854	1m USB 2.0 USB-C to USB Mini-B Cable - Black
88855	2m USB 2.0 USB-C to USB Mini-B Cable - Black
88856	3m USB 2.0 USB-C to USB Mini-B Cable - Black
88857	4m USB 2.0 USB-C to USB Mini-B Cable - Black

88862



USB 3.0 (USB 3.1 GEN 1) USB-C TO USB MICRO-B CABLE MALE TO MALE - BLACK

Connect a USB Micro-B device to a USB Type-C port on a laptop, desktop computer, tablet, or other device

This USB 3.0 (USB 3.1 Gen 1) USB-C to USB Micro-B cable is perfect for connecting a smartphone, tablet, or other device that has a USB Micro-B port to a computer, tablet or other device that has a USB Type-C port for USB 3.0 (USB 3.1 Gen 1) communication. The colour-coded USB Type-C connector allows this cable to be easily identified as a USB 3.0 (USB 3.1 Gen 1) cable and differentiated from other cables which may support a different feature set. The USB Type-C connector is smaller than traditional USB connector and features a symmetrical design which allows it to be easily connected on the first try. The durability of the USB Type-C connector allows for up to 10,000 connection cycles. This cable supports a data rate up to 5Gbps for data transfer and sync with 5 volts and 1 amp of power for device operation and charging.

Item #	Description
88862	1m USB 3.0 USB-C to USB Micro-B Cable - Black
88863	2m USB 3.0 USB-C to USB Micro-B Cable - Black
88864	3m USB 3.0 USB-C to USB Micro-B Cable - Black

88865



USB 3.0 (USB 3.1 GEN 1) USB-C TO USB-B CABLE MALE TO MALE - BLACK

Connect a USB-B device to a USB Type-C port on a laptop, desktop computer, or tablet

This USB 3.0 (USB 3.1 Gen 1) USB-C to USB-B cable is the perfect solution for connecting a hard drive, hub, or other device that has a USB-B port to a computer, tablet or other device that has a USB Type-C port for USB 3.0 (USB 3.1 Gen 1) communication. The colour-coded USB Type-C connector allows this cable to be easily identified as a USB 3.0 (USB 3.1 Gen 1) cable and differentiated from other cables which may support a different feature set. The USB Type-C connector is smaller than traditional USB connector and features a symmetrical design which allows it to be easily connected on the first try. Additionally, the durability of the USB Type-C connector allows for up to 10,000 connection cycles. This cable supports a data rate up to 5Gbps for data transfer and sync with 5 volts and 1 amp of power for device operation and charging.

Item #	Description
88865	1m USB 3.0 USB-C to USB-B Cable - Black
88866	2m USB 3.0 USB-C to USB-B Cable - Black
88867	3m USB 3.0 USB-C to USB-B Cable - Black

88868



USB 3.0 (USB 3.1 GEN 1) USB-C TO USB-A ADAPTER MALE TO FEMALE - BLACK

Adapt a USB-A device to a USB Type-C port on a laptop, desktop computer, or tablet

This USB 3.0 (USB 3.1 Gen 1) USB-C to USB-A adapter is perfect for connecting a flash drive, keyboard, mouse, or other device that has a USB-A connector to a laptop or desktop computer that has a USB Type-C port for USB 3.0 (USB 3.1 Gen 1) communication. The colour-coded USB Type-C connector allows this cable to be easily identified as a USB 3.0 (USB 3.1 Gen 1) cable and differentiated from other cables which may support a different feature set. The USB Type-C connector is smaller than traditional USB connector and features a symmetrical design which allows it to be easily connected on the first try. Additionally, the durability of the USB Type-C connector allows for up to 10,000 connection cycles. This cable supports a data rate up to 5Gbps for data transfer and sync with 5 volts and 1 amp of power for device operation and charging.

Item #	Description
88868	USB 3.0 (USB 3.1 Gen 1) USB-C to USB-A Adapter Male to Female - Black

81560



81565

USB 2.0 A MALE TO B MALE CABLES

Connect your USB device to the USB port on your USB hub, desktop PC, or Mac®

Just plug and play for keyboards, mice, modems, printers, and other USB peripherals. This cable provides a transfer rate up to 480Mbps depending upon the peripheral's USB version, and easily attaches to any USB device. Foil and braid shielding reduces EMI/RFI interference and twisted pair construction helps reduce crosstalk, thus ensuring high speed data transfer.

Item #	Description
81560	1m USB 2.0 A Male/B Male Cable - White
81561	2m USB 2.0 A Male/B Male Cable - White
81562	3m USB 2.0 A Male/B Male Cable - White
81563	5m USB 2.0 A Male/B Male Cable - White
81565	1m USB 2.0 A Male/B Male Cable - Black
81566	2m USB 2.0 A Male/B Male Cable - Black
81567	3m USB 2.0 A Male/B Male Cable - Black
81568	5m USB 2.0 A Male/B Male Cable - Black

81570



USB-A MALE TO A FEMALE EXTENSION CABLES

Extend the distance of your USB-A/B cable

When you need just a little more distance, this cable will extend the reach of your USB-A/B cable. Foil and braid shielding reduce EMI/RFI interference and twisted pair construction helps reduce crosstalk for a high speed, error-free data transfer. Designed for use with low speed, low power devices only; not USB 2.0 compatible. PC and Mac® compatible.

Item #	Description
81570	1m USB-A Male/A Female Extension Cable
81571	2m USB-A Male/A Female Extension Cable
81572	3m USB-A Male/A Female Extension Cable

Please Note: Not for use beyond a total extended single length of 5 metres. For longer lengths or high powered devices, please see active extension cables below.

81665



USB 2.0 A MALE TO A FEMALE ACTIVE EXTENSION CABLE

Item #	Description
81665	5m USB 2.0 A Male/A Female Active Ext. Cable

Extend your USB connection 5 more metres

This extension cable actively buffers the incoming and outgoing signals to ensure compliance with USB's 2.0 specification for electrical and timing minimums. You can connect up to four active extension cables end-to-end to achieve up to 20 metres total extension! Both low and high speed USB devices will function equally well with this extension.

81655



USB 2.0 A MALE TO A FEMALE ACTIVE EXTENSION CABLE

Item #	Description
81655	5m USB 2.0 A Male/A Female Active Ext. Cable
81656	12m USB 2.0 A Male/A Female Active Ext. Cable

USB extension solution for PC and Mac® users

These extension cables actively buffer the incoming and outgoing signals to ensure compliance with USB's 2.0 specification for electrical and timing minimums. You can connect up to four active extension cables end-to-end to achieve up to 20 metres total extension! Both low and high speed USB devices will function equally well with this extension.

81574



USB-A MALE TO A MALE CABLE

Connect USB devices with an "A Female" port to your desktop computer or other USB device

Item #	Description
81574	1m USB 2.0 A Male/A Male Cable - Black
81575	2m USB 2.0 A Male/A Male Cable - Black

Just plug and play for keyboards, mice, modems, printers, and other USB peripherals. This cable provides a transfer rate up to 480Mbps depending upon the peripheral's USB version, and easily attaches to any USB device. Foil and braid shielding reduces EMI/RFI interference and twisted pair construction helps reduce crosstalk thus ensuring high speed, error-free data transfer. Please Note: This cable is not intended to connect two computers together or to connect a USB hub between two computers. Doing so may cause irreparable damage to your computers. We offer a USB file share cable (#86000) to connect two computers.

81580



USB 2.0 A MALE TO 5-PIN MINI-B MALE CABLE

Connect your 5-pin Mini-USB camera or device to the USB port on your USB hub, desktop PC or Mac®. Works for many camera models from the major brands.

A handy replacement for a lost cable, or a nice spare for the office. Just plug and play for many digital camera models, cellphones, MP3 players, PDAs, and other Mini-USB devices. This cable provides a transfer rate up to 480Mbps depending upon the peripheral's USB version.

Item #	Description
81580	1m USB 2.0 A Male to 5-Pin Mini-B Male Cable
81581	2m USB 2.0 A Male to 5-Pin Mini-B Male Cable

81583



USB 2.0 A MALE TO 4-PIN MINI-B MALE CABLE

Connect your 4-pin Mini-USB camera or device to the USB port on your USB hub, desktop PC or Mac®. Works for many camera models from the major brands.

A handy replacement for a lost cable, or a nice spare for the office. Just plug and play for many digital camera models, cellphones, MP3 players, PDAs, and other Mini-USB devices. This cable provides a transfer rate up to 480Mbps depending upon the peripheral's USB version.

Item #	Description
81583	1m USB 2.0 A Male to 4-Pin Mini-B Male Cable
81584	2m USB 2.0 A Male to 4-Pin Mini-B Male Cable

81700



USB 2.0 A MALE TO MICRO-USB-B MALE CABLE

Connect your portable USB device to a Micro-USB port on your computer or other USB device

Connect to mobile phones, GPS systems, PDAs, OTG devices, and digital cameras by using the Micro-USB connection on your computer or other USB device. The Micro-USB connector is smaller and thinner than the previous USB Mini-B standard while offering better performance.

Item #	Description
81700	1m USB 2.0 A Male to Micro USB-B Male Cable
81701	2m USB 2.0 A Male to Micro USB-B Male Cable
81702	3m USB 2.0 A Male to Micro USB-B Male Cable

81704



USB 2.0 A RIGHT ANGLE MALE TO USB MICRO-B RIGHT ANGLE MALE CABLE

Connect your portable USB device to a micro-USB port on your computer or other USB device

Connect to mobile phones, GPS systems, PDAs, OTG devices and digital cameras by using the Micro-USB connection on your computer or other USB device. The Micro-USB connector is smaller and thinner than the previous USB Mini-B standard while offering better performance. Its small right angle form factor is ideal for today's compact portable devices while easily transferring data or charging your device at a transfer speed up to 480Mbps. This cable is compliant with USB 2.0 specifications and the On-The-Go supplement.

Item #	Description
81704	1m USB 2.0 A Right Angle Male to USB Micro-B Right Angle Male Cable
81705	1m USB 2.0 A Right Angle Male to USB Micro-B Right Angle Male Cable
81706	1m USB 2.0 A Right Angle Male to USB Micro-B Right Angle Male Cable

81708



USB CHARGING CABLE

Ultra flexible solution for charging a smartphone, tablet or other mobile device

The USB Charging Cable is the ideal solution for charging a smartphone, tablet or other mobile device. The 30 gauge conductor construction provides the flexibility to connect in even the tightest of spaces. This flexibility and the compact size of this cable make it the ideal portable solution.

Item #	Description
81708	.46m USB Charging Cable

81709



USB CHARGING Y CABLE

Ultra flexible solution for charging two smartphones, tablets or other mobile devices

The USB Charging Y Cable is the ideal solution for charging two smartphones, tablets or other mobile devices. The 30 gauge conductor construction provides the flexibility to connect in even the tightest of spaces. This flexibility and the compact size of this cable make it the ideal portable solution.

Item #	Description
81709	.25m USB Charging Y Cable



USB CHARGE AND SYNC CABLES

Easily charge your Samsung® Galaxy, Google™ Nexus™ and Amazon Kindle™ devices and sync files with your PC with these select cables

These cables are designed for charging and syncing your tablet devices. These cables make it easy to transfer videos, photos, e-books or other content to or from the tablet. They are perfect as a replacement for a lost cable or used as a spare when traveling. These cables provide the right amount of clearance to place your tablet in a secure location while charging or syncing and are compatible with both PC and Mac®. Performance is guaranteed through a lifetime warranty.

Item #	Description
81711	6ft Samsung Galaxy Charge and Sync Cable
81712	3ft Google Nexus Charge and Sync Cable
81713	3ft Kindle Charge and Sync Cable

81577



USB 2.0 ONE MINI-B MALE TO TWO A MALE Y CABLE

Increase the power running to a portable hard drive from your PC or Mac®

When a standard USB cable cannot transfer enough power to operate an external device, such as a portable 2.5 inch hard drive, you need a USB 2.0 Y cable. Simply plug this cable's USB Mini-B end into the device, and then plug the two USB-A ends into open USB ports on one desktop PC or Mac®. This cable then pulls power from both USB ports, and thus increases the output to the external drive.

The red snagless hood on the auxiliary USB-A connector enables the user to quickly distinguish between main and auxiliary power. Foil and braid shielding reduces EMI/RFI interference, and twisted pair construction reduces crosstalk for high speed, error-free data transfer.

Item #	Description
81577	2m USB 2.0 One Mini-B Male to Two A Male Y Cable

81578



USB 2.0 ONE B MALE TO TWO A MALE Y CABLE

Increase the power running to a portable hard drive from your PC or Mac®

When a standard USB cable cannot transfer enough power to operate an external device, such as a portable 2.5 inch hard drive, you need a USB 2.0 Y cable. Simply plug this cable's USB-B end into the device, and then plug the two USB-A ends into open USB ports on one desktop PC or Mac. This cable then pulls power from both USB ports, and thus increases the output to the external drive.

The red snagless hood on the auxiliary USB-A connector enables the user to quickly distinguish between main and auxiliary power. Foil and braid shielding reduces EMI/RFI interference, and twisted pair construction reduces crosstalk for high speed, error-free data transfer.

Item #	Description
81578	2m USB 2.0 One B Male to Two A Male Y Cable

81689



USB MINI-B/MICRO-B ADAPTER

Adapter allows USB Mini-B to USB Micro-B conversion

The Mini-USB to Micro-USB 2.0 Adapter allows you to convert your Mini-USB cables to Micro-USB cables providing a cost effective alternative to having multiple different cables to accommodate different USB connections (Micro/Mini-USB). This adapter features Mini-USB female (B-type) and a Micro-USB male (B-type) connector access.

Item #	Description
81689	USB Mini-B/Micro-B Adapter

80932



MICRO USB TO HDMI® MHL® ADAPTER CABLE

Adapt and MHL-enabled device with a Micro USB connector to HDMI

Convert a Micro USB-B port to an HDMI connection on MHL-enabled devices. It will support up to 1080p video with up to 7.1 channel digital audio while providing power to the mobile device. You can watch high definition movies, view photos, play games, and surf the web while also viewing the content on your TV. A USB power cable must be connected to power the adapter, which will also allow charging the phone or tablet.

Note: This adapter can only convert the Micro USB-B connection if the phone or tablet is compatible with MHL. Please check if your phone/tablet is compatible.

Item #	Description
80932	Micro USB-B to HDMI MHL Adapter Cable

80934



MOBILE DEVICE USB MICRO-B TO HDMI® DISPLAY SLIMPORTRM ADAPTER CABLE

Connect a mobile device to the HDMI port on a display using SlimPort technology

The Mobile Device USB Micro-B to HDMI Display SlimPort Adapter Cable is the perfect solution for connecting the USB Micro-B port of a SlimPort-enabled tablet, smartphone or other mobile device to the HDMI port on a display. This adapter will support up to a 1080p resolution with up to 7.1 channel digital audio depending upon the capabilities of the mobile device and the display. This adapter will allow high definition movies, photos, games, the Internet browser and other content from the mobile device to be shown on the connected display.

Connecting a separate USB-A to Micro-B cable (not included) to the USB Micro-B female port on the adapter is not required for operation of the adapter, but may be used to charge the mobile device while content is being shown on the display. SlimPort technology makes this connection easy and does not require a driver, software or lengthy setup time.

Item #	Description
80934	Mobile Device USB Micro-B to HDMI Display SlimPort Adapter Cable

USB CABLES & ADAPTERS

82410



MOBILE DEVICE USB MICRO-B TO USB DEVICE OTG ADAPTER CABLE

Connect a USB flash drive, mouse, keyboard, or other USB device directly to a tablet, smartphone, or other mobile device using USB On-The-Go (OTG) Technology

The 1.5cm Mobile Device USB Micro-B to USB Device OTG Adapter Cable is the perfect solution for expanding the capabilities of an OTG-enabled tablet, smartphone, or other mobile device by directly connecting a USB device such as a USB flash drive for additional storage, or a USB keyboard and mouse for additional control.

Item #	Description
82410	0.15m USB Micro-B Male to USB-A Female OTG

86050



USB-A MALE TO LIGHTNING™ MALE SYNC AND CHARGING CABLE

Use with the latest generation Apple® iPad®, iPhone® or iPod® devices to sync and charge

The USB-A Male to Lightning Male Sync and Charging Cable is perfect for downloading data from or uploading data to the latest generation of Apple iPad, iPhone or iPod devices while also allowing the device to be charged. The cable construction and design make it ideal for travel. This cable is great as a replacement or a spare to sync and charge an Apple device at home, in the office or on the go. This cable is MFi certified for compatibility with Apple products.

Item #	Description
86050	1m USB-A Male to Lightning Male Sync and Charging Cable - Black
86051	1m USB-A Male to Lightning Male Sync and Charging Cable - White

81677



USB 3.0 A MALE TO A MALE CABLE

Compliant to USB 3.0 SuperSpeed specifications; extend your USB 3.0 connection

Just plug and play for hard drive enclosures, printers, modems, cameras, and other SuperSpeed USB peripherals. This cable provides a transfer rate of up to 4.8Gbps when connected with a USB 3.0 compliant host and device. Foil and braid shielding reduces EMI/RFI interference and twisted pair construction helps reduce crosstalk thus ensuring SuperSpeed, error-free data transfer. Protective over moulded connector is colour-coded blue to highlight USB 3.0 connectivity compatibility.

Item #	Description
81677	1m USB 3.0 A Male to A Male Cable – Black
81678	2m USB 3.0 A Male to A Male Cable – Black
81679	3m USB 3.0 A Male to A Male Cable – Black

81680



USB 3.0 A MALE TO B MALE CABLE

Compliant to USB 3.0 SuperSpeed specifications; connect your SuperSpeed USB peripheral for TEN TIMES the transmission rate of USB 2.0

Just plug and play for hard drive enclosures, printers, modems, cameras, and other SuperSpeed USB peripherals. This cable provides a transfer rate of up to 4.8Gbps when connected with a USB 3.0 compliant host and device. Foil and braid shielding reduces EMI/RFI interference and twisted pair construction helps reduce crosstalk thus ensuring SuperSpeed, error-free data transfer. Protective over moulded connector is colour-coded blue to highlight USB 3.0 connectivity compatibility.

Item #	Description
81680	1m USB 3.0 A Male to B Male Cable – Black
81681	2m USB 3.0 A Male to B Male Cable – Black
81682	3m USB 3.0 A Male to B Male Cable – Black

81683



USB 3.0 A MALE TO MICRO-B MALE CABLE

Compliant to USB 3.0 SuperSpeed specifications; connect your SuperSpeed Micro USB device for TEN TIMES the transmission rate of USB 2.0

Just plug and play for hard drive enclosures, printers, modems, cameras, and other SuperSpeed USB peripherals. This cable provides a transfer rate of up to 4.8Gbps when connected with a USB 3.0 compliant host and device. Foil and braid shielding reduces EMI/RFI interference and twisted pair construction helps reduce crosstalk thus ensuring SuperSpeed, error-free data transfer. Protective over moulded connector is colour-coded blue to highlight USB 3.0 connectivity compatibility.

Item #	Description
81683	1m USB 3.0 A Male to Micro B Male Cable
81684	2m USB 3.0 A Male to Micro B Male Cable
81685	3m USB 3.0 A Male to Micro B Male Cable

81497



USB TO PS/2 ADAPTER

Convert a USB keyboard or mouse port to a PS/2 port

This adapter connects your USB keyboard or mouse to a PS/2 port on your computer. Simply plug this compact adapter into any PS/2 port, then connect your mouse or keyboard.

Please Note: The adapter only functions with items that are compatible with both USB And PS/2 signal types.

Item #	Description
81497	USB to Single PS/2 Adapter

81644



USB TO PS/2 KEYBOARD/MOUSE ADAPTER CABLE

Use your PS/2 compatible keyboard/mouse on a USB port

This USB to dual PS/2 adapter cable is the ideal way to connect PS/2 devices on USB systems. The adapter will connect a PS/2 keyboard and mouse through one USB port from a computer or USB hub. Colour coded connectors for easy identification; no power adapter is needed. Just plug and play for easy installation. Supports Microsoft® IntelliMouse® and compatible mice.

Item #	Description
81644	0.3m USB to PS/2 Keyboard/Mouse Adapter Cable

81672



USB 2.0 TO FAST ETHERNET ADAPTER

USB 2.0 for high speed connectivity

With its 480Mbps of available bandwidth, you get true 10/100 network access. The plug and play design makes this adapter the most convenient and efficient way to connect a laptop or desktop computer to a Fast Ethernet network. With our Fast Ethernet adapter, you can experience the full speed of your Fast Ethernet network without the need for opening your PC and adding internal network adapters.

Our adapter allows you to share the Internet or printers, transfer files, compete in multiplayer games, and more—at speeds up to 200Mbps (in full duplex mode). The portable, compact size makes it ideal for use with laptops. Hot-swappable and 100% compatible with both USB 2.0 and 1.1 hardware.

Item #	Description
81672	USB 2.0 to Fast Ethernet Adapter

81692



USB 2.0 TO GIGABIT ETHERNET ADAPTER

Convert a USB 2.0 port to a Gigabit Ethernet connection

The Gigabit USB 2.0 Ethernet Adapter is a cost effective solution for converting an existing USB port to a 10/100/1000Base-T Ethernet port without replacing or adding a new network card. With this adapter, users can create a new network connection that allows them to connect to another network or computer without the need for a router or switch. The auto sensing feature detects the correct connection speed whether 10, 100 or 1000Base-T. With speeds up to 480Mbps, file transfer between computers is fast and easy, even with large amounts of multimedia data. The adapter works on older model computers that have no Ethernet port installed, so upgrades are quick and convenient. Simply plug in the adapter and load the included software driver to get 1000Base-T connection speeds. This flexible solution requires no external power supply.

Item #	Description
81692	USB 2.0 to Gigabit Ethernet Adapter

81693



USB 3.0 TO GIGABIT ETHERNET NETWORK ADAPTER

Connect to the Internet using a high bandwidth USB 3.0 port while supporting Gigabit Ethernet data speeds

The USB 3.0 to Gigabit Ethernet Network Adapter is the perfect solution for converting an existing USB 3.0 port to a Gigabit Ethernet port for connecting to a network or the Internet without replacing or adding a new network card. This adapter utilises the high bandwidth of the USB 3.0 port to support true Gigabit Ethernet speeds. This flexible solution requires no external power supply, simply connect the adapter to an available USB 3.0 port, install the included software driver and connect a Cat5 cable from the adapter to an RJ45 Network port. With speeds up to 1000Mbps, file transfer between computers is fast and easy, even with large amounts of multimedia data.

Item #	Description
81693	25ft S-video + 3.5mm to Composite Audio

81621



USB SUPERBOOSTER EXTENDER

Pocket-sized, this device boosts the distance of your USB device up to 45 metres

Item #	Description
81620	Superbooster USB Extender
81621	Superbooster USB Extender

Conquer USB length limitations, and put your USB devices where you want them with our USB Superbooster. This pocket-sized device extends the distance of a USB device to a host computer up to 45 metres so you can place your USB camera, printer, web cam, keyboard/mouse extension, or any other USB device exactly where you want it. This booster is powerful yet simple, with no drivers to install or special software required, so it's compatible with any computer that supports USB.

This plug and play device consists of a base unit and a remote unit connected together by a standard Cat5, Cat5e, or Cat6 network cable (not included). Simply connect your cables to your device; then connect to your computer and USB peripheral and you're up and running. Bus-powered, it requires no external power source. Instead, the Superbooster has internal DC power conditioning circuits to maintain the proper voltage to the remote device so no external power is required for either the base or remote units. Compliant with USB Specification 1.1.

Note: 81620 is suitable for Promethean whiteboards and 81621 is not.

81688



USB INFRARED PC/MEDIA REMOTE

Control your PC/Media Centre with an easy-to-use remote

Item #	Description
81688	USB Infrared PC/Media Remote

Control your PC/Media Centre from across the room with this sleek and easy to use PC/Media Remote. The Infrared (IR) signal from the remote can be picked up by the sensor from up to 6 metres away, providing flexibility convenience in equipment placement. The sensor is connected to your computer via a USB 2.0 connection. Using this remote, you can power your TV and Media Centre through on-screen menus that are specially designed for remote control interaction.

81557



2-PORT USB INTERNAL AT MOTHERBOARD ADAPTER

Add USB connectivity to your AT motherboard

Item #	Description
81557	0.30m 2-Port USB Internal AT Motherboard Adapter

Installs in any empty desktop PC slot to add two USB ports to an AT motherboard with a 10-pin header. Connectors are two 5-pin headers to dual series A ports.

81642



2-PORT USB 3.0 SUPERSPEED PCI EXPRESS CARD

Add two USB 3.0 SuperSpeed ports with transfer rates up to 10 times faster than USB 2.0

Item #	Description
81642	2-Port USB 3.0 SuperSpeed PCI Express Card

The 2-Port USB 3.0 SuperSpeed PCI Express Card adds SuperSpeed USB capabilities to your computer with two USB 3.0 A male ports. It connects internally via the PCIe connector; simply install this card into an available PCI slot on your computer to add two USB 3.0 SuperSpeed A male ports. SuperSpeed USB supports transfer rates up to 5Gbps, 10 times faster than USB 2.0. This card is ideal for quickly transferring large amounts of data from such devices as external hard drives, memory card readers, real-time video cameras, and other data intensive USB devices. Backwards compatible with USB 2.0, and also has improved power efficiency over USB 2.0.

81930

81931

81932

81933



USB 3.0 TO VGA/DVI/HDMI/DISPLAYPORT VIDEO ADAPTERS – EXTERNAL VIDEO CARD

Add up to six additional displays for duplicate or extended desktop using USB ports

Item #	Description
81930	USB 3.0 to VGA Video Adapter
81931	USB 3.0 to DVI Video Adapter
81932	USB 3.0 to HDMI Audio/Video Adapter
81933	USB 3.0 to DisplayPort Audio/Video Adapter

The USB to A/V Adapter – External Video Cards are the perfect solution for adding duplicate or extended desktop to a computer utilising a USB port. The duplicate feature allows a user to show the same images from the primary display on a secondary display. This is useful in situations where a presentation must be given. The extended desktop feature allows the user to expand the desktop workspace from the primary display to both the primary and secondary display, allowing different images to be shown on the two monitors. This is useful for increasing productivity when working in multiple applications or comparing data between two programs.

These adapters are designed for compatibility with USB 3.0 ports. The USB 3.0 specification provides up to ten times the bandwidth of USB 2.0, which allows these adapters to support full motion video. Additionally, they have a low power requirement which, when used with a mobile laptop, will allow the laptop battery to last longer.

The software required for operation of these adapters is included and is easy to install and configure. Once the software is installed, up to six adapters may be connected to the computer allowing multi-display capability. High definition resolutions of up to 2560x1600 are supported, and video streaming is supported at a resolution of up to 1080p. With a compact form factor and rugged housing, these adapters combines functionality and durability, ensuring optimal performance and results.

EXPANDED RANGE OF **USB-C** PRODUCTS

CHECK OUT ALL OF OUR USB-C PRODUCTS ON PAGES 45-47



NEW CONNECTOR | MORE BANDWIDTH | ENHANCED POWER



USB-A/V ADAPTERS

81651



2-PORT USB HUB

Easily add an additional USB port to your PC or laptop

This hub connects up to two USB 2.0 devices with just one cable. Two USB-A female ports will receive your mice, printers, hubs, or other USB devices without them being cluttered together. Unlike traditional USB hubs, this cable can slide behind your desk and out of the way, or connect on the front of a desktop so you won't need to reach in the back of the PC. With its small form factor it eliminates the clutter associated with traditional hubs, and lets you spread out your devices. Bus-powered, so it requires no external power adapters. Compliant with USB 2.0 specifications; compatible with both PC and Mac® computers.

Item #	Description
81651	USB 2.0 2-Port Passive Hub

81647



4-PORT USB 2.0 LAPTOP HUB WITH 0.45M BLUE LED INDICATOR CABLE

Quickly add more USB 2.0 ports to your laptop or desktop PC

Many laptops (especially the older ones) have only one builtin USB port, and don't allow you to multi-task with several peripherals. This laptop hub expands your USB configuration and provides three extra ports for connecting peripherals. Ideal for keyboards, mice, and other low-powered USB devices. Small, lightweight and portable, it just stores in your laptop's case or pocket.

With a transfer rate up to 480Mbps, it's fully USB 2.0 compliant and compatible with all USB peripherals, and USB-enabled desktop PC and Mac® computers. Because it's bus-powered, there is no need for an additional power supply. The LED indicator on the cable shows when your hub is being powered.

Item #	Description
81647	4-Port USB 2.0 Laptop Hub with 0.45m Blue LED Indicator Cable

81645



4-PORT AND 7-PORT USB 2.0 ALUMINIUM HUBS

Add four or seven USB 2.0 ports to your Mac® or PC; hubs include hard-mountable metal base

Our aluminium hubs conveniently add four or seven high speed USB 2.0 ports to your desktop or laptop computer. The slim form factor saves space while the port placement and hard-mountable metal base keeps the hubs in place even when several USB devices are connected. The removable aluminium base can be hard-mounted to your desk. These hubs easily slide from their base, making it convenient for travel as well.

The hubs can be self-powered from the USB port, or utilise the included AC power supply adapter. Downstream ports have automatic connect and speed detection plus overcurrent protection with auto recovery. Add additional hubs to daisychain up to 127 devices.

Item #	Description
81645	4-Port USB 2.0 Aluminium Hub w/Power Adapter
81646	7-Port USB 2.0 Aluminium Hub w/Power Adapter

81650



2-PORT USB 2.0 MANUAL SWITCH

Share digital cameras or other USB devices between two desktop PCs

Share USB devices among four or seven desktop PCs or quickly extend the number of USB devices shared by using a USB hub to daisy-chain up to 127 devices. Hot key functionality enables use of a keyboard to switch among computers, while the LED port status indicator shows which computer is selected. Plug and play functionality makes installation of these hubs simple.

Item #	Description
81650	2-Port USB 2.0 Manual Switch
81659	4-Port USB 2.0 Manual Switch

81649



4-PORT USB 3.0 SUPERSPEED HUB

Easily add four additional USB 3.0 ports for SuperSpeed USB 3.0

The USB 3.0 4-Port Hub is compliant with the USB 3.0 specification while also being backward compatible with the USB 2.0 specification. The USB SuperSpeed Hub allows for easy connection of up to four USB 3.0 devices to your computer, such as an MP3 players, digital cameras, or hard drives. The streamlined, sleek and compact design is the perfect solution for USB port expansion. The removable aluminium base can be hard-mounted to your desk. The hub easily slides from the base, making it convenient for travel as well.

Item #	Description
81649	4-Port USB 3.0 SuperSpeed Hub

HOW TO CONNECT DEVICES WITH DIFFERENT SIGNAL TYPES USING ADAPTERS AND CONVERTERS



What are you trying to do?	Adapter/ Converter Part #	Attach Recommendations 1	Attach Recommendations 2
My source device has USB 3.0			
Connect a USB 3.0 device to an HDMI display	81932	HDMI cable	Longer length USB 3.0 cable than what's included
Connect a USB 3.0 device to a VGA display	81930	VGA cable	Longer length USB 3.0 cable than what's included
Connect a USB 3.0 device to a DisplayPort display	81933	DisplayPort cable	Longer length USB 3.0 cable than what's included
Connect a USB 3.0 device to a DVI-D display	81931	DVI-D cable	Longer length USB 3.0 cable than what's included
My source device has DisplayPort			
Connect a DisplayPort device to a DVI-D display	84323	VGA cable	
Connect a DisplayPort device to a VGA display	84332	N/A	
Connect a DisplayPort device to an HDMI display	84322	HDMI cable	
Connect a DisplayPort device to a DVI-D display	84321	DVI-D cable	
Connect a DisplayPort device to a DVI-D display	84328, 84329 or 84330	N/A	
My source device has Mini DisplayPort			
Connect a Mini DisplayPort device to a DVI-D display	84312 or 84311	DVI-D cable	
Connect a Mini DisplayPort device to a VGA display	84316 or 84315	VGA cable	
Connect a Mini DisplayPort device to an HDMI display	84314 or 84313	HDMI cable	
Connect a Mini DisplayPort device to an DisplayPort display	84297, 84298 or 84299	N/A	
My source device has Micro-USB			
Connect a Micro-USB with MHL device to an HDMI display	80932	HDMI cable	
My source device has DVI-D			
Connect a DVI-D device to a VGA display	82401	DVI-D cable	VGA cable
My source device has VGA			
Connect a VGA device to an HDMI display	89024	VGA cable	HDMI cable
Connect a VGA device to a Composite video display	89039	Different length VGA cable	Different length Composite cable
Connect a VGA device to an S-Video or Composite video display	89019	Different length VGA cable	Different length S-Video or Composite video cables
My source device has USB			
Connect a USB device to an HDMI display	81637	HDMI cable	Different length USB cable than what's included
Connect a USB device to a VGA display	81638	VGA cable	Different length USB cable than what's included
Connect a USB device to a DVI-D display	81636	DVI-D cable	Different length USB cable than what's included
My source device has HDMI			
Connect an HDMI device to a VGA display	81699	HDMI cable	VGA cable
My source device has Composite			

SERIAL & PARALLEL

81626



USB IEEE-1284 PARALLEL PRINTER ADAPTER CABLE

Attach your IEEE-1284 printer to your USB port

Don't waste the parallel port on your inkjet, laser, or high speed printer. These cables use the USB port on your computer or hub, so your parallel port remains free for a zip drive or scanner. Forget the hassles of IRQ sharing by adapting your printer to USB. If you have multiple printers, you can eliminate the need for a switchbox by connecting each printer to a USB port.

Item #	Description
81626	1.8m USB IEEE-1284 Parallel Printer Adapter Cable
81629	2m USB to DB25 IEEE-1284 Parallel Printer Adapter Cable

81632



USB TO DB9 SERIAL ADAPTER CABLE

Convert a DB9 or a DB25 serial device to USB; great for PDAs and digital cameras

Connecting USB with the traditional RS232 serial port, these adapters connect cellphones, PDAs, digital cameras, modems, or ISDN terminal adapters through your USB port. They have a data transfer rate of over 230Kbps. Since the adapters use no IRQs, there are no IRQ conflicts, and they are ideal for when you need many serial devices attached to your PC. They free up your RS232 port for other uses.

Item #	Description
81632	0.45m USB to DB9 Serial Adapter Cable
81671	1.8m USB to Serial DB25 Adapter Cable

81363



DB9 FEMALE TO FEMALE CABLE

Convert an existing DB9 M/M cable to a DB9 M/F cable

Don't sacrifice convenience when determining where to place your hardware. A DB9 F/F cable can convert an existing DB9 M/M cable to a DB9 M/F cable for added flexibility. Each cable comes fully shielded to prevent unwanted EMI/RFI interference, and the fully snagless cable design delivers excellent strain relief. Connector thumbscrews provide a quick and easy connection every time. All lines are wired straight through.

Item #	Description
81363	2m DB9 Female/Female Cable - Black
81364	3m DB9 Female/Female Cable - Black
81365	5m DB9 Female/Female Cable - Black

81376



DB9 MALE TO FEMALE EXTENSION CABLE

Extend your RS 232 serial cable for more flexibility

Don't sacrifice convenience when determining where to place your hardware. A DB9 extension cable can give you the flexibility to extend a computer peripheral wherever you need it. Each cable comes fully shielded to prevent unwanted EMI/RFI interference, and the fully snagless cable design delivers excellent strain relief. Connector thumbscrews provide a quick and easy connection every time.

Item #	Description
81376	1m DB9 Male/Female Extension Cable - Black
81377	2m DB9 Male/Female Extension Cable - Black
81378	3m DB9 Male/Female Extension Cable - Black
81379	5m DB9 Male/Female Extension Cable - Black
81380	7m DB9 Male/Female Extension Cable - Black
81381	10m DB9 Male/Female Extension Cable - Black
81382	15m DB9 Male/Female Extension Cable - Black

81387



DB25 MALE TO MALE CABLE

Attach your printer, modem, or other RS 232 serial/parallel device to a switchbox

All 25 lines are wired straight through pin-to-pin for ease of compatibility. Each cable is foil shielded for EMI/RFI protection, and is fully snagless with thumbscrew connectors for a fast, easy connection every time.

Item #	Description
81387	1m DB25 Male to Male Cable
81388	2m DB25 Male to Male Cable
81389	3m DB25 Male to Male Cable
81390	5m DB25 Male to Male Cable
81392	10m DB25 Male to Male Cable
81394	20m DB25 Male to Male Cable
81395	30m DB25 Male to Male Cable

81396



DB25 MALE TO FEMALE EXTENSION CABLE

Extend your RS232 serial or parallel cable

Easily extend your cables at a lower cost than buying a new cable. All 25 lines are wired straight through pin-to-pin for ease of compatibility. Each cable is foil shielded for EMI/RFI protection, and is fully snagless with thumbscrew connectors for a fast, easy connection every time.

Item #	Description
81396	1m DB25 Male to Female Extension Cable
81397	2m DB25 Male to Female Extension Cable
81398	3m DB25 Male to Female Extension Cable
81399	5m DB25 Male to Female Extension Cable
81400	7m DB25 Male to Female Extension Cable
81401	10m DB25 Male to Female Extension Cable
81402	15m DB25 Male to Female Extension Cable
81403	20m DB25 Male to Female Extension Cable
81404	30m DB25 Male to Female Extension Cable

81405



DB37 MALE TO FEMALE EXTENSION CABLE

Extend your DB37 cable for more flexibility

Make sure the important files from your CPU are backed up on a regular basis. Extend your cable connection for your tape backup or Bernoulli Box applications for reliable data storage and retrieval. Our line of extension and replacement cables are fully shielded against EMI/RFI interference to ensure quality transmissions every time.

Item #	Description
81405	1m DB37 Male to Female Extension Cable
81406	2m DB37 Male to Female Extension Cable

81442



DB9 TO DB25 SERIAL ADAPTER

Converts a DB9 male port to a DB25 female port or a DB25 male port to a DB9 female port

An inexpensive alternative to buying a new cable. Use this adapter when you need to convert a DB9 port to DB25 or vice versa. The snagless design provides a solid connection, and each adapter is fully shielded against outside EMI/RFI interference. With its straightthrough design, this adapter is 100% compatible with all serial devices.

Item #	Description
81442	DB9 Female to DB25 Female Serial Adapter
81443	DB9 Female to DB25 Male Serial Adapter
81444	DB9 Male to DB25 Female Serial Adapter
81445	DB9 Male to DB25 Male Serial Adapter

81416



DB9 FEMALE TO FEMALE NULL MODEM CABLE

Attach two desktop PC serial ports

Our line of null modem serial cables allows two DTE or DCE devices to communicate with no conflict in data transmission. The transmit and receive signals are crossed to ensure proper data transmission. Each null modem cable is designed with a rugged, over moulded construction that provides added strain relief and a solid connection each time. Plus the cable is foil shielded for EMI/RFI protection from surrounding office equipment and fluorescent lights.

Item #	Description
81416	0.5m DB9 F/F Null Modem Cable – Black
81417	1m DB9 F/F Null Modem Cable – Black
81418	2m DB9 F/F Null Modem Cable – Black
81419	3m DB9 F/F Null Modem Cable – Black
81420	5m DB9 F/F Null Modem Cable – Black

81434



DB9 FEMALE TO DB25 MALE MODEM CABLE

Attach an external modem to the desktop PC's DB9 serial port

Each modem serial cable is designed for long-lasting integrity, regardless of modem baud rates. Plus the cable is fully snagless and foil shielded for EMI/RFI protection from surrounding office equipment and fluorescent lights. Thumbscrew connectors provide a fast, easy connection every time. The hoods have long, easy-to-grip, slotted thumbscrews for neat, easy and durable connections.

Item #	Description
81434	1m DB9 Female to DB25 Male Modem Cable
81435	2m DB9 Female to DB25 Male Modem Cable
81436	3m DB9 Female to DB25 Male Modem Cable

81449



DB9 MALE TO DB9 FEMALE AND DB9 FEMALE TO DB25 FEMALE NULL MODEM ADAPTERS

Quick, economical solution to connect laptop serial ports

Convert a serial cable into a null modem cable with this handy adapter; a quick and easy fix for your DTE or DCE incompatibilities. Crossing the data transmission lines in straightthrough serial cables, this adapter will connect two RS232 serial ports. The adapter's snagless design provides a solid connection while shielding against outside EMI/RFI interference.

Item #	Description
81449	DB9 Male to DB9 Female Null Modem Adapter
81450	DB9 Female to DB25 Female Null Modem Adapter

81450



81458



IEEE-1284 DB25 MALE TO CENTRONICS 36 MALE PARALLEL PRINTER CABLE

Provides increased speed and functionality over standard parallel cabling; attach IEEE-1284-compliant printers, scanners, and other compliant peripherals to your desktop PC

This cable enables high speed, bi-directional communication between a desktop PC and a peripheral. Foil Shielded to provide maximum resistance against harmful EMI/RFI, and help you to achieve the maximum performance.

Item #	Description
81458	1m IEEE-1284 DB25M/C36M Parallel Printer Cbl
81459	2m IEEE-1284 DB25M/C36M Parallel Printer Cbl
81460	3m IEEE-1284 DB25M/C36M Parallel Printer Cbl
81461	5m IEEE-1284 DB25M/C36M Parallel Printer Cbl
81462	7m IEEE-1284 DB25M/C36M Parallel Printer Cbl
81463	10m IEEE-1284 DB25M/C36M Parallel Printer Cbl
81464	15m IEEE-1284 DB25M/C36M Parallel Printer Cbl

81472



IEEE-1284 DB25 MALE TO MALE AND FEMALE TO FEMALE PARALLEL CABLES

Connect IEEE-1284 compliant printers, scanners, HP® tape drives, lomega® devices, and other compliant peripherals to your desktop PC

These cables provide increased speed and functionality over standard parallel cabling. 17-pair wire twisted with at least 36 turns per metre, snagless connectors, foil shielding to provide maximum resistance against harmful EMI/RFI, and help you to achieve the maximum performance.

Item #	Description
81472	2m IEEE-1284 DB25 Male to Male Parallel Cable
81473	3m IEEE-1284 DB25 Male to Male Parallel Cable
81474	5m IEEE-1284 DB25 Male to Male Parallel Cable
81470	2m IEEE-1284 DB25 Male to Female Parallel Ext. Cbl
81471	3m IEEE-1284 DB25 Male to Female Parallel Ext. Cbl

81478



1M DB25 MALE TO CENTRONICS 36 MALE PARALLEL PRINTER CABLE

Connect your desktop PC to a parallel dot-matrix printer, older laser printer, or other uni-directional Centronics peripheral

Get a reliable connection between your desktop PC and uni-directional, dot-matrix, or older laser printer. Tough enough for use in industrial settings. Fully snagless for excellent strain relief, this cable also provides excellent foil shielding to protect valuable data from EMI/RFI interference. Each connector is designed with slotted, textured thumbscrews to make attachment and removal easy. All 25 conductors are wired for ease of compatibility.

Item #	Description
81478	1m DB25 Male to C36 Male Parallel Printer Cable
81479	2m DB25 Male to C36 Male Parallel Printer Cable
81480	3m DB25 Male to C36 Male Parallel Printer Cable
81481	5m DB25 Male to C36 Male Parallel Printer Cable
81483	10m DB25 Male to C36 Male Parallel Printer Cable
81484	15m DB25 Male to C36 Male Parallel Printer Cable

81505



CENTRONICS 36 MINI GENDER CHANGER AND DB25 PARALLEL PRINTER ADAPTERS

Convert your printer cables for parallel printer applications

Quickly change the gender of your 36-pin connector, or join two cables together. Save the cost and hassle of buying a new cable by just changing the gender of your existing port and using the cable you already have.

Convert your parallel port to connect a 36-pin Centronics cable; transform your male-to-male all-lines DB25 cable into a parallel printer cable, or simply join two cables together.

Item #	Description
81505	C36 Female to Female Mini Gender Changer
81506	C36 Female to DB25 Female Parallel Printer Adapter
81507	C36 Female to DB25 Male Parallel Printer Adapter

81465



IEEE-1284 DB25 MALE TO MICROCENTRONICS 36 MALE PARALLEL PRINTER CABLE

Provides increased speed and functionality over standard parallel cabling. Connect your HP® Deskjet, LaserJet, DesignJet or OfficeJet printer to your desktop PC

To enjoy the increased data rate and two-way communication of your IEEE-1284-compliant printer or scanner, you need a cable with high quality connectors and a specialised wire type. Our cable exploits this technology to enable high speed, bi-directional communication between a desktop PC and a peripheral. Foil shielded to provide maximum resistance against harmful EMI/RFI interference.

Item #	Description
81465	2m IEEE-1284 DB25M/MC36M Parallel Printer Cbl
81466	3m IEEE-1284 DB25M/MC36M Parallel Printer Cbl
81467	5m IEEE-1284 DB25M/MC36M Parallel Printer Cbl

81508



81509

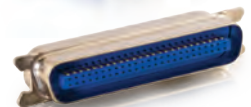

CENTRONICS 50 FEMALE TO FEMALE AND MALE TO MALE GENDER CHANGERS (COUPLERS)

Quickly change the gender of your 50-pin connector, or join two cables together

Save the cost and hassle of buying a new cable by just changing the gender of your port and using the cable you already have. Each changer is snagless and fully shielded, preventing any unwanted EMI/RFI interference caused from office equipment.

Item #	Description
81508	Centronics 50 Female to Female Gender Changer
81509	Centronics 50 Male to Male Gender Changer

81511



81514



81521

DB15, DB25, DB37 AND DB9 GENDER CHANGERS AND PORT SAVER ADAPTERS (COUPLER)

Quickly change the gender of your connectors, or join two cables together

Save the cost and hassle of buying a new cable by just changing the gender of your port and using the cable you already have. Our port saver adapters help your system withstand the stress of plugging and unplugging cables and will quickly and easily extend the life of your equipment's connectors. Each of our changers are snagless and fully shielded, preventing any unwanted EMI/RFI interference caused from office equipment.

Item #	Description
81511	DB15 Female to Female Mini Gender Changer
81513	DB15 Male to Male Mini Gender Changer
81514	DB25 Female to Female Gender Changer
81515	DB25 Female to Female Mini Gender Changer
81517	DB25 Male to Male Gender Changer
81518	DB25 Male to Male Mini Gender Changer
81519	DB37 Female to Female Mini Gender Changer
81520	DB9 Female to Female Gender Changer
81521	DB9 Female to Female Mini Gender Changer
81522	DB9 Male to Female Port Saver Adapter
81523	DB9 Male to Male Gender Changer
81524	DB9 Male to Male Mini Gender Changer

81498



81501



AT MALE/FEMALE AND PS/2 MALE/FEMALE KEYBOARD ADAPTER CABLES

Save money by adapting your older keyboard

Be environmentally-friendly and save money at the same time. Fully snagless to protect against EMI/RFI interference. It's the ideal solution for putting older working equipment to good use.

Item #	Description
81499	0.15m PS/2 Female AT Male Keyboard Adapter
81501	PS/2 Female to AT Male Keyboard Adapter
81502	PS/2 6-Pin Mini Din F/F Gender Changer

81489



PS/2 MALE/FEMALE KEYBOARD/ MOUSE EXTENSION CABLE

Extend your PS/2 cable for your mouse or keyboard for greater flexibility

Free up space between components by extending your mouse or keyboard cable. Each PS/2 cable is constructed from top quality foil-shielded wire to prevent EMI/RFI interference, and is fully snagless to ensure excellent strain relief and a clean, professional appearance.

Item #	Description
81489	2m PS/2 Male to Female Keyboard Mouse Ext Cbl
81490	3m PS/2 Male to Female Keyboard Mouse Ext Cbl
81491	5m PS/2 Male to Female Keyboard Mouse Ext Cbl

87187



VELOCITY™ DB9 MALE TO 3.5MM MALE ADAPTER CABLE

Adapt your 3.5mm stereo jack for RS232 serial control

Why run all new cables for RS232 control of your audio/video system, when you can use this easy adapter? The Velocity RS232 adapter leverages your DB9 or 3.5mm stereo audio cable to run 3-conductor RS232 control signals between your control unit and your video display. Fully moulded DB9 and 3.5mm connectors provide excellent strain relief. This adapter is ideal for use with computers, projectors, and any control unit/display requiring 3-conductor RS232 serial control.

Please Note: Not all serial control methods are supported by this adapter. This product is intended only for use with 3-wire RS232 control cables with common ground (pin 5), transmit data (pin 3), and receive data (pin 2).

Item #	Description
87187	0.5m Male to 3.5mm Male Adapter Cable
87188	0.5m Female to 3.5mm Male Adapter Cable

SERIAL & PARALLEL

81818



7-PIN 1-DEVICE SERIAL ATA CABLES

Connect Serial ATA devices to your motherboard or host controller; for transfer rates up to 6G

SATA 3.0 compatible with transfer rates up to 6Gbps. This serial ATA cable is designed to handle the differential signals implemented in today's technology, while delivering increased throughput and reduced data packet loss. With our 7-pin, 1-device cable, you'll receive higher data transmission rates, reduced crosstalk, and improved signal integrity.

Item #	Description
81818	0.5m 7-Pin 180° 1-Device Serial ATA Cable
81819	1m 7-Pin 180° 1-Device Serial ATA Cable
81824	0.5m 7-Pin 180° to 90° 1-Device Serial ATA Cable
81825	1m 7-Pin 180° to 90° 1-Device Serial ATA Cable
81826	0.5m 90° to 90° 7-Pin 1-Device Serial ATA Cable
81827	1m 90° to 90° 7-Pin 1-Device Serial ATA Cable

81814



81808



SERIAL ATA TO EXTERNAL SERIAL ATA CABLE

Connect eSATA devices to SATA controllers; hot-pluggable with transfer rates up to 6G

Connect eSATA devices to SATA controllers with the Type A connector, or eSATA controllers to SATA drive enclosures with the Type A connector. This cable meets SATA I and SATA II specifications. eSATA provides more performance than existing solutions, is hot-pluggable, and is also SATA 3.0 compatible.

Item #	Description
81808	1m Serial ATA to External Serial ATA Cable
81809	2m Serial ATA to External Serial ATA Cable

81800



EXTERNAL SERIAL ATA CABLE

Hot-pluggable with transfer rates up to 6G

eSATA provides more performance than existing solutions and is hot-pluggable. You can now utilise shielded cable lengths up to 2 metres outside the desktop PC to take advantage of the benefits the SATA interface brings to storage.

With eSATA, you get a robust and userfriendly external connection with high performance and cost effective expansion storage.

Item #	Description
81800	1m External Serial ATA Cable
81801	2m External Serial ATA Cable

SAS 32-PIN TO FOUR SATA 22-PIN WITH 4-PIN POWER CABLE

6Gbps serial interface delivers the next generation standard for SCSI-based systems

SATA 3.0 compatible with transfer rates up to 6Gbps. Designed to replace the SCSI parallel interface with a much faster, more flexible, 6Gbps serial interface while maintaining the robust nature of the SCSI command set. The flexibility of SAS facilitates many system-level configurations such as workstations, blade servers, external storage arrays, SAS expanders, host bus adapters (HBAs), and RAID controllers.

Item #	Description
81814	0.5m SAS 32-Pin to 4 SATA 22-Pin + 4-Pin

81853



SERIAL ATA POWER ADAPTER CABLE

Convert a 5.25in power connector into a serial ATA power connector

This cable converts one 5.25in power connector into one serial ATA power connector. Use for serial ATA hard drives, CD-ROMs, CDRWVs, tape drives, fans, etc.

Item #	Description
81853	0.15m Serial ATA Power Adapter Cable

81854



SERIAL ATA DUAL POWER SPLITTER CABLE

Power two SATA drives with one cable

Connect two high speed serial ATA drives to your power chain with this splitter cable. This power connector can be used with both 3.5in and 2.5in serial ATA devices.

Item #	Description
81854	0.15m Serial ATA Dual Power Splitter Cable

81849



ONE 5-1/4IN TO TWO 5-1/4IN INTERNAL POWER Y CABLE

Split one 5-1/4in power connector into two 5-1/4in power connectors

Our quad splitter cable can attach additional floppy drives, removable storage drives, hard drives, CD-ROMs, CDRWVs, tape drives, fans, etc. to your computer's power supply. Quality-made to meet industry standards; a reliable solution to power your devices.

Item #	Description
81849	0.15m - One 5.25in to Two 5.25in Internal Power Y Cable

81845



ONE 5-1/4IN TO TWO 5-1/4IN INTERNAL POWER Y CABLE

Split one 5-1/4in power connector into two 5-1/4in power connectors

Out of power connectors? Our quad splitter cable is the answer, and can attach additional floppy drives, removable storage drives, hard drives, CD-ROMs, CD-RWs, tape drives, fans, etc. to your computer's power supply. Quality-made to meet industry standards; a reliable solution to power your devices.

Item #	Description
81845	0.35m – One 5.25in to Two 5.1in Internal Power Y Cable

81846



ONE 5-1/4IN TO TWO 3-1/2IN INTERNAL POWER Y CABLE

Split one 5-1/4in power connector into two 3-1/2in power connectors

Out of power connectors? Our quad splitter cable is the answer, and can attach additional floppy drives, removable storage drives, hard drives, CD-ROMs, CD-RWs, tape drives, fans, etc. to your computer's power supply. Quality-made to meet industry standards; a reliable solution to power your devices.

Item #	Description
81846	0.25m – One 5.25in to Two 3.5in Internal Power Y Cable

81847



ONE 5-1/4IN TO ONE 3-1/2IN WITH ONE 5-1/4IN INTERNAL POWER Y CABLE

Split one 5-1/4in power connector into one 5-1/4in and one 3-1/2in power connectors

Out of power connectors? Our quad splitter cable is the answer, and can attach additional floppy drives, removable storage drives, hard drives, CD-ROMs, CD-RWs, tape drives, fans, etc. to your computer's power supply. Quality-made to meet industry standards; a reliable solution to power your devices.

Item #	Description
81847	0.25cm – One 5.25in to One 3.5in with One 5.25in Internal Power Y Cable

81848



INTERNAL POWER QUAD SPLITTER CABLE

Split one 5.25in power connector into four 5.25in power connectors

Out of power connectors? Our quad splitter cable is the answer, and can attach additional floppy drives, removable storage drives, hard drives, CD-ROMs, CD-RWs, tape drives, fans, etc. to your computer's power supply. Quality-made to meet industry standards; a reliable solution to power your devices.

Item #	Description
81848	0.76m – Internal Power Quad Splitter Cable

81859



ATX 20-PIN POWER SUPPLY TO 24-PIN MOTHERBOARD ADAPTER CABLES

Don't buy a new power supply—save money and use this adapter cable instead

Power your new motherboard by using your existing ATX power supply. This adapter cable connects a 24-pin ATX power supply to a 20-pin ATX motherboard power connector. Many ATX power supplies and cases ship with a 24-pin power supply connector; save money and use our adapter cable to convert the power supply to use with standard 20-pin ATX motherboards. Designed for all ATX-style power supplies.

Item #	Description
81859	ATX Power Cable 20-Pin Female to 24-Pin Male
81860	ATX Power Cable 20-Pin Male to 24-Pin Female

81862



**ATX POWER SUPPLY TO PENTIUM®
4 POWER ADAPTER CABLE**

Upgrade to a Pentium 4 motherboard without buying a new power supply

This adapter cable connects a standard 4-pin Molex (LP4) power connector to the special onboard 4-pin P4 power connector.

Item #	Description
81862	0.25m – ATX Power Supply to Pentium 4 Power Adapter Cable

81863



**MPC-2 CD-ROM AUDIO
CABLE-61M**

Quality-made for a clean sound

Choose a CD-ROM audio cable that delivers a clean, noise-free sound. Made from first-rate audio-grade wire and top-quality connector systems, this audio cable will not disappoint.

Item #	Description
81863	0.61m MPC-2 to MPC-2 CD-Rom Audio Cable

81836



**LAPTOP TO IDE HARD DRIVE
ADAPTER CABLE**

The easy way to retrieve files from a laptop that won't start up

Connect your 2.5in laptop's IDE hard drive to a standard 40-pin IDE cable for installation in a desktop or tower PC. This adapter features 44-pin female to 40-pin male connectors, and a power feed. This adapter makes file transfer to/from your laptop to your desktop quick and easy. Just connect your laptop's 2.5in drive to this adapter, and connect the adapter to our USB 2.0 to IDE drive adapter. Then plug the USB to IDE adapter into an available USB port on your desktop. Your 2.5in drive will appear as a logical drive, and will allow you to pull files directly back and forth.

Item #	Description
81836	0.15m Laptop to IDE Hard Drive Adapter Cable

BENEFIT OF SELLING CABLES AND CONNECTIVITY

SCENARIO:

Your customer wants 80 LCD displays at £125.00 each. You know that you can apply a 3.5% margin uplift.

To ensure the LCD displays work with the intended application, your customer needs 80, 3 metre male to male DisplayPort cables at £15.00 each.

The margin opportunity here is 30%.

Hardware Profit

Amount of Hardware Sold (i.e. Displays, Laptops, Desktops, Projectors)	£10,000.00
Hardware Profit Margin as a Percentage	3.5%
Hardware Profit Margin in Pounds	£350.00

Cable/Accessories Profit

Amount of Connectivity Sold (i.e. DisplayPort Cables, HDMI Cables, DVI-D Cables)	£1,200.00
Connectivity Profit Margin as a Percentage	30%
Connectivity Profit Margin in Pounds	£360.00

SIMPLIFIED CONNECTIVITY

It's Our Expertise & Solutions, It's Your Experience... It's Who We Are

Simplified Connectivity is more than just designing and manufacturing easy-to-use and easy-to-install connectivity products. It's the expertise of the people that provide technical and sales support. It's the confidence in knowing that the products and solutions you buy from C2G are tried and tested by people like yourself every day. It's the planning and thoughtfulness that goes into creating the kind of user expertise that our customers want and expect. Simplified Connectivity is about people, products, and performance — C2G is leading the competition in all three.

TECHNICAL EXPERTISE



C2G supports our customers with FREE technical and sales support on all of our products. All of our technical experts have been thoroughly trained on C2G products, typical applications, and many have earned industry-recognized certifications in specific fields of technology. In addition to our people, C2G's website is an endless portal of technical information for everyone — from a first-time user to a veteran installer.

STRAIGHT FORWARD SOLUTIONS



C2G products are designed to be easy-to-use and easy-to-install. We create products based on customer feedback, and we stay akin to where the IT and A/V industries are going in the next five years. We strive to create solutions that meet or exceed customer expectations.

EFFORTLESS EXPERIENCE



The effortless experience is defined by you, our customers, and C2G is constantly changing and adapting in order to meet your product and service demands. When you email, text, call, or live chat, you are speaking to a C2G employee that is literally surrounded by product managers, technical support experts, a finance team, and peer sales representatives. Our goal is to make doing business with C2G easy, regardless of the way you choose to interact with us.

Products and Solutions of Simplified Connectivity

C2G product solutions fit effortlessly into the spaces where you work, share, and connect. Our products go into the data centers that power the networks you rely on, connect the personal devices you use throughout the day, and make your work spaces highly productive and efficient.

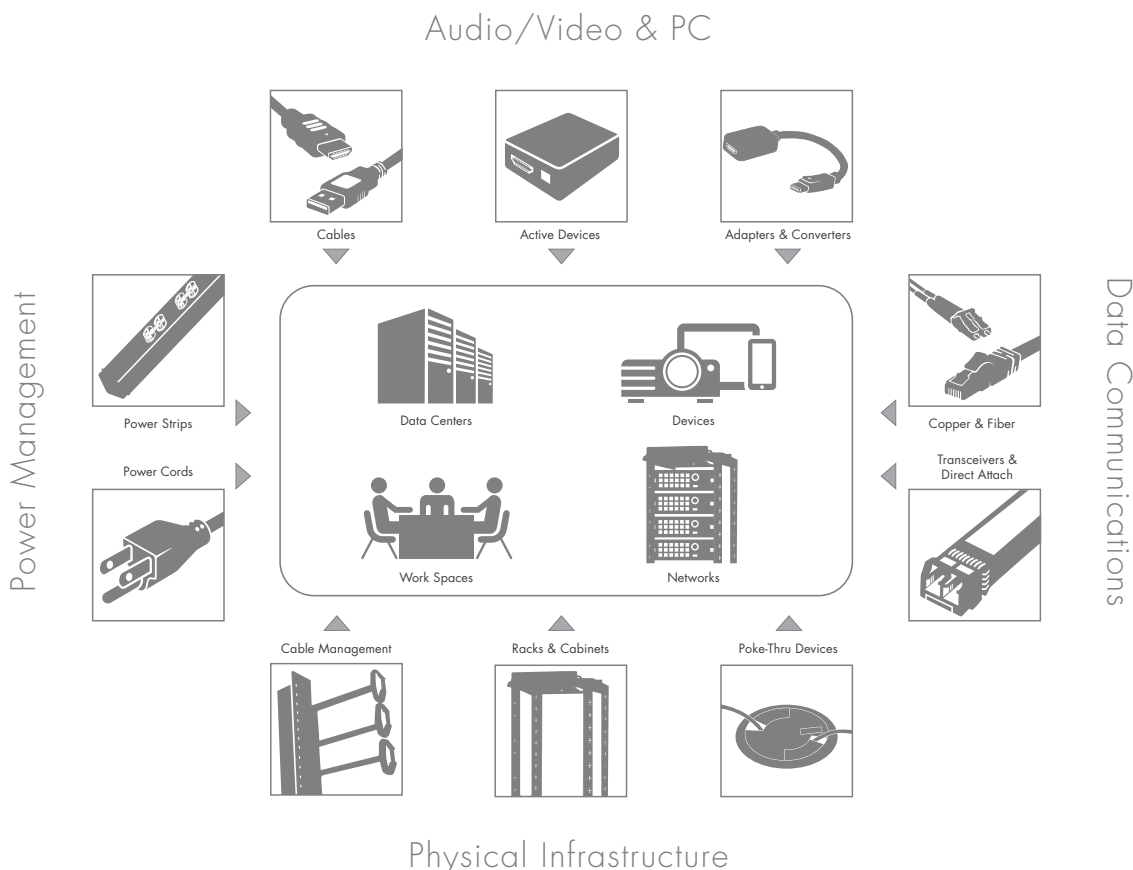

POWER SOLUTIONS



NEW



INTRODUCING AN EXPANDED LINE OF LEGRAND* BRANDED POWER SOLUTIONS

Offering a wider selection of fully specified, competitively priced global power solutions. A perfect add-on to our existing power offerings.

NOW AVAILABLE

- Multi-Outlet Extension Products
 - With switches
 - With power consumed indicators
 - For meeting rooms
- Power Adapters
- Surge Protectors
- Pop Up Mounting Boxes
- Entry Level, UPS
- Floor Trunking Accessories

POWER PRODUCT BENEFITS

- Competitively Priced
- Horizontal and Vertical Options
- Selection of Plugs for Multiple Uses



*C2G proudly joined Legrand Group in 2014

LEGRAND® OVER FLOOR TRUNKING

SKU	Item Description
80879	Legrand Over Floor Trunking - 50x12mm
80880	Legrand Over Floor Trunking - 55x18mm
80881	Legrand Over Floor Trunking - 92x20mm



80880



80792

80801

80788

80798

LEGRAND® SURGE PROTECTORS

SKU	Item Description
80788	Legrand Protected Socket - 2P+E + 2xRJ45 Socket - Volt Surge Protector - German Standard
80790	Legrand Protected Socket - 2P+E + 2xUSB + Phone - Volt Surge Protector - German Standard
80789	Legrand Protected Socket 1x2P+T 16A F/B + 2xRJ45 + Surge Arrester
80791	Legrand USB Charger 1x2P+T 16A F/B + 2xUSB + Tel Support + Surge Arrester + 1m Micro-USB Reel
80792	Legrand Vertical Multi-Socket Unit - 4x2P+E + 2xUSB + 1xMicro-USB + Surge Arrester - French/Belgium Standard - 2m Cord
80794	Legrand Multi-Socket Unit - 4x2P+E + 2xRJ45 + Surge Arrester - French/Belgium Standard - 1.5m Cord
80800	Legrand Multi-Socket Unit - 6x2P+E + 2xRJ45 + 2xTV + Surge Arrester - French/Belgium Standard - 1.5m Cord
80793	Legrand Multi-Outlet Extension - 4x2P+E + 1 Socket + 2xUSB Charger - German Standard - White/Grey
80798	Legrand Multi-Outlet Extension for Comfort/Safety - 4x2P+E + V.S.P. - 1.5m Cord
80799	Legrand Multi-Outlet Extension for Comfort/Safety - 6x2P+E + V.S.P. - 1.5m Cord
80795	Legrand Multi-Outlet Extension - 4x2P+E + 2xRJ45 - German Standard - White/Grey
80802	Legrand Multi-Outlet Extension - Masters Slave Function - 6x2P+E - 1.5m Cord
80796	Legrand Unit 4x2P+T Surge Arrester F - 1.5m Cord
80797	Legrand Unit 6x2P+T Surge Arrester F - 1.5m Cord
80803	Legrand Multi-Outlet Extension - Masters Slave Function - 6x2P+E - 1.5m Cord
80801	Legrand Multi-Outlet Extension - 6x2P+E + 2xRJ45 + 2xTV - German Standard - Black



80865



80822

LEGRAND® MULTI-OUTLET EXTENSIONS

SKU	Item Description
80813	Legrand Multi-Outlet Extension for Comfort - 3x2P+E Orientable - 1.5m Cord
80814	Legrand Multi-Outlet Extension for Comfort - 3x2P+E Orientable - 3m Cord
80815	Legrand Multi-Outlet Extension for Comfort - 4x2P+E Orientable - 1.5m Cord
80816	Legrand Multi-Outlet Extension for Comfort - 4x2P+E Orientable - 3m Cord
80817	Legrand Multi-Outlet Extension for Comfort - 5x2P+E Orientable - 1.5m Cord
80818	Legrand Multi-Outlet Extension for Comfort - 5x2P+E Orientable - 3m Cord
80819	Legrand Multi-Outlet Extension for Comfort - 6x2P+E Orientable - 1.5m Cord
80820	Legrand Multi-Outlet Extension for Comfort - 6x2P+E Orientable - 3m Cord
80821	Legrand Multi-Outlet Extension for Comfort - 3x2P+E Orientable - 1.5m Cord
80824	Legrand Multi-Outlet Extension for Comfort - 3x2P+E Orientable - 3m Cord
80822	Legrand Multi-Outlet Extension for Comfort - 4x2P+E Orientable - 1.5m Cord
80825	Legrand Multi-Outlet Extension for Comfort - 4x2P+E Orientable - 3m Cord
80823	Legrand Multi-Outlet Extension for Comfort - 6x2P+E Orientable - 1.5m Cord
80826	Legrand Multi-Outlet Extension for Comfort - 6x2P+E Orientable - 3m Cord
80827	Legrand Multi-Outlet Extension for Comfort/Safety - 4x2P+E + Indicator - 1.5m Cord
80829	Legrand Multi-Outlet Extension for Comfort/Safety - 4x2P+E + Indicator - 3m Cord
80828	Legrand Multi-Outlet Extension for Comfort/Safety - 6x2P+E + Indicator - 1.5m Cord
80830	Legrand Multi-Outlet Extension for Comfort/Safety - 6x2P+E + Indicator - 3m Cord
80831	Legrand Unit 4x2P+T + 1.5m AV. Inter Prothether - French/Belgium Standard
80832	Legrand Unit 6x2P+T + 1.5m AV. Inter Prothether - French/Belgium Standard
80804	Legrand Multi-Outlet Extension - 3x2P+E 16A Lateral - French Standard - White
80805	Legrand Multi-Outlet Extension - 3x2P+E 16A Lateral - French Standard - Transparent
80806	Legrand Multi-Outlet Extension - 2x2P+E FR Lateral Extraction - French Standard
80807	Legrand Multi-Outlet Extension - 2x2P+E 16A Vertical - French Standard
80808	Legrand Multi-Outlet Extension - 3x2P+E 16A Horizontal - French Standard
80867	Legrand Meeting Room Multi-Outlet - with 8 Sockets - French Standard
80865	Legrand Meeting Room Multi-Outlet - with Non-Manageable Switch - French Standard
80866	Legrand Meeting Room Multi-Outlet - with Non-Manageable Switch + HD15 + Jack Socket - French Standard
80870	Legrand Meeting Room Multi-Outlet - with 8 Sockets - Schuko Standard
80868	Legrand Meeting Room Multi-Outlet - with Non-Manageable Switch - Schuko Standard
80869	Legrand Meeting Room Multi-Outlet - with Non-Manageable Switch + HD15 + Jack Socket - Schuko Standard



LEGRAND® POWER DESK GROMMETS

SKU	Item Description
80844	Legrand Power Desk Grommet 1 Socket 2P+E - French Standard - 2m Cord - White Finish
80845	Legrand Power Desk Grommet 1 Socket 2P+E - French Standard - 2m Cord - Black Finish
80846	Legrand Power Desk Grommet 1 Socket 2P+E - French Standard - 2m Cord - Black and Metal Finish
80847	Legrand Power Desk Grommet 1 Socket 2P+E - USB Charger - French Standard - 2m Cord - White Finish
80848	Legrand Power Desk Grommet 1 Socket 2P+E - USB Charger - French Standard - 2m Cord - Black Finish
80849	Legrand Power Desk Grommet 1 Socket 2P+E - USB Charger - French Standard - 2m Cord - Black and Metal Finish
80850	Legrand Power Desk Grommet 1 Socket 2P+E - USB Charger + RJ45 Cat6 FTP Retractor - French Standard - 2m Cord - White Finish
80851	Legrand Power Desk Grommet 1 Socket 2P+E - Schuko Standard - 2m Cord - White Finish
80852	Legrand Power Desk Grommet 1 Socket 2P+E - Schuko Standard - 2m Cord - Black Finish
80853	Legrand Power Desk Grommet 1 Socket 2P+E - Schuko Standard - 2m Cord - Black and Metal Finish
80854	Legrand Power Desk Grommet 1 Socket 2P+E - USB Charger - Schuko Standard - 2m Cord - White Finish
80855	Legrand Power Desk Grommet 1 Socket 2P+E - USB Charger - Schuko Standard - 2m Cord - Black Finish
80856	Legrand Power Desk Grommet 1 Socket 2P+E - USB Charger - Schuko Standard - 2m Cord - Black and Metal Finish
80857	Legrand Power Desk Grommet 1 Socket 2P+E - USB Charger + RJ45 Cat6 UTP Retractor - Schuko Standard - 2m Cord - White Finish
80858	Legrand Power Desk Grommet 1 Socket 2P+E - British Standard - 2m Cord - White Finish
80859	Legrand Power Desk Grommet 1 Socket 2P+E - British Standard - 2m Cord - Black Finish
80860	Legrand Power Desk Grommet 1 Socket 2P+E - British Standard - 2m Cord - Black and Metal Finish
80861	Legrand Power Desk Grommet 1 Socket 2P+E - USB Charger - British Standard - 2m Cord - White Finish
80862	Legrand Power Desk Grommet 1 Socket 2P+E - USB Charger - British Standard - 2m Cord - Black Finish
80863	Legrand Power Desk Grommet 1 Socket 2P+E - USB Charger - British Standard - 2m Cord - Black and Metal Finish
80864	Legrand Power Desk Grommet 1 Socket 2P+E - USB Charger + RJ45 Cat6 UTP Retractor - British Standard - 2m Cord - White Finish

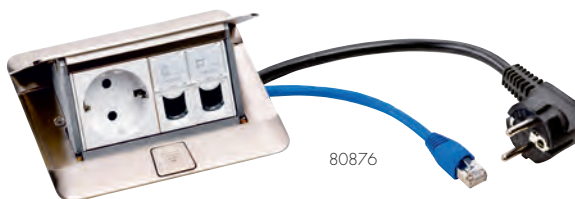

LEGRAND® POP-UP MOUNTING BOXES

SKU	Item Description
80871	Legrand Pop-Up White 1 Socket 2P+E - 2xRJ45 Data Socket Cat.6 FTP - French Standard
80872	Legrand Pop-Up Stainless Steel 1 Socket 2P+E - 2xRJ45 Data Socket Cat.6 FTP - French Standard
80873	Legrand Pop-Up White 2 Socket 2P+E - 2xRJ45 Data Socket Cat.6 FTP + HD15 Connector + 3.5mm Jack - French Standard
80874	Legrand Pop-Up Stainless Steel 2 Socket 2P+E - 2xRJ45 Data Socket Cat.6 FTP + HD15 Connector + 3.5mm Jack - French Standard
80875	Legrand Pop-Up White 1 Socket 2P+E - 2xRJ45 Data Socket Cat.6 FTP - German Standard
80876	Legrand Pop-Up Stainless Steel 1 Socket 2P+E - 2xRJ45 Data Socket Cat.6 FTP - German Standard
80877	Legrand Pop-Up White 2 Socket 2P+E - 2xRJ45 Data Socket Cat.6 FTP + HD15 Connector + 3.5mm Jack - German Standard
80878	Legrand Pop-Up Stainless Steel 2 Socket 2P+E - 2xRJ45 Data Socket Cat.6 FTP + HD15 Connector + 3.5mm Jack - German Standard



80841



80840

LEGRAND® UPS

SKU	Item Description
80841	Legrand UPS 600VA/360W - Equipped with 8 German Standard Sockets
80843	Legrand UPS 800VA/480W - Equipped with 8 German Standard Sockets
80840	Legrand UPS 600VA/360W - Equipped with 8 French/Belgium Standard Sockets
80842	Legrand UPS 800VA/480W - Equipped with 8 French/Belgium Standard Sockets



80811



80809



80812

LEGRAND® TRAVEL ADAPTERS

SKU	Item Description
80809	Legrand German to French Standard Adaptor - 2P+E - 16A - with Safety Shutters - White
80810	Legrand British to French/German Standard Adaptor - 2P+E - 16/13A - with Safety Shutters - White
80811	Legrand US to European Standard Adaptor - 2P - with Safety Shutters - White
80812	Legrand European to US Standard Adaptor - 2P - with Safety Shutters - White

LEGRAND® LIGHTING



80838

SKU	Item Description
80836	Legrand Dimmable Night Lamp - White
80837	Legrand Dimmable Night Lamp - Black
80838	Legrand Spotlight with Battery - White
80839	Legrand Spotlight with Battery - Black



80834

LEGRAND® USB ADAPTERS & CHARGERS

SKU	Item Description
80834	Legrand USB Adapter - White
80835	Legrand USB Adapter - Black
80833	Legrand Dual USB Car Charger Kit 12V-2.1A Max

C2G POWER CORD PRODUCT LINE

Your Complete Network Offering

C2G has expanded its popular power cord line to offer a wider selection of fully specified, competitively priced global power cords, power cord extensions and power cord splitters—all with a lifetime warranty.

These products are convenient when you need to replace a lost or overused power cord. They are also useful when you need a shorter or longer power cord length to better fit your application. There is also a power cord splitter line available when you need to power multiple devices with one outlet.

- Wider selection of power cord products and lengths
- Product specifications are accessible online at www.c2g.com
- Lifetime warranty

80603



UK LAPTOP POWER CORD (BS 1363 TO IEC 60320 C5)

Replacement power cord for many laptops

Replace your overused or misplaced power cable, or just get some extra cords for convenience. This power cord is designed to work with laptops that use a 3-slot power cord. This 18AWG cord features a fully moulded design for maximum durability and long life. (Clover Leaf connector)

Item #	Description
80600	0.5m BS 1363 to IEC60320 C5 Power Cord
80601	1m BS 1363 to IEC60320 C5 Power Cord
80602	2m BS 1363 to IEC60320 C5 Power Cord
80603	3m BS 1363 to IEC60320 C5 Power Cord

80608



EUROPEAN LAPTOP POWER CORD (CEE 7/7 TO IEC 60320 C5)

Replacement power cord for many laptops

Replace your overused or misplaced power cable, or just get some extra cords for convenience. This power cord is designed to work with laptops that use a 3-slot power cord. This heavy duty 18AWG cord features a fully moulded design for maximum durability and long life. (Clover Leaf connector)

Item #	Description
80606	1m CEE 7/7 to IEC60320 C5 Power Cord
80607	2m CEE 7/7 to IEC60320 C5 Power Cord
80608	3m CEE 7/7 to IEC60320 C5 Power Cord

80613



UK NON-POLARISED POWER CORD (BS 1363 TO IEC 60320 C7)

Replacement power cord for laptops, gaming consoles and other non-polarised devices

Replace your overused or misplaced power cable, or just get some extra cords for convenience. This non-polarised power cord is designed to work with laptops, gaming consoles, and other A/V equipment that uses a 2-slot non-polarised power cord. (Figure-8 connector)

Item #	Description
80611	1m BS 1363 to IEC60320 C7 Power Cord
80612	2m BS 1363 to IEC60320 C7 Power Cord
80613	3m BS 1363 to IEC60320 C7 Power Cord

80647



SWISS LAPTOP POWER CORD (SEV 1011 TO IEC 60320 C5)

Replacement power cord for many laptops

Replace your overused or misplaced power cable, or just get some extra cords for convenience. This power cord is designed to work with laptops that use a 3-slot power cord. This 0.75mm² cord features a fully moulded design for maximum durability and long life.

The female connector, often called a Clover Leaf connector, plugs directly into the device while the male connector plugs into a standard outlet.

Item #	Description
80647	2m Swiss Laptop Power Cord (SEV 1011 to IEC 60320 C5)

80616



EUROPEAN NON-POLARISED POWER CORD (CEE 7/7 TO IEC 60320 C7)

Replacement power cord for laptops, gaming consoles and other non-polarised devices

This non-polarised power cord is designed to work with laptops, gaming consoles and other A/V equipment that uses a 2-slot non-polarised power cord. This heavy duty 18AWG cord features a fully moulded design for maximum durability and long life. (Figure-8 connector)

Item #	Description
80616	1m CEE 7/7 to IEC60320 C7 Power Cord
80617	2m CEE 7/7 to IEC60320 C7 Power Cord
80618	3m CEE 7/7 to IEC60320 C7 Power Cord

80624

16AWG 250 VOLT 16 AMP POWER EXTENSION CORD (IEC 60320 C20 TO IEC 60320 C19)

Extend your power cord for more flexibility

Make your work environment more flexible and efficient. This heavy duty 16AWG cord is designed to work with PDUs, PSUs and other high power devices that use the 3-pin male-to-female shroud power connector. It also features a fully moulded design for maximum durability and long life.

Item #	Description
80621	0.5m IEC60320 C20 to C19 Power Ext. Cord
80622	1m IEC60320 C20 to C19 Power Ext. Cord
80623	2m IEC60320 C20 to C19 Power Ext. Cord
80624	3m IEC60320 C20 to C19 Power Ext. Cord



80626

250 VOLT 16 AMP POWER CORDS (IEC 60320 C19)

Power high current IT appliances such as PDUs, PSUs, and high powered servers

Make your work environment more flexible and efficient. This heavy duty 17AWG cord is designed to work with PDUs, PSUs, and other high power devices that use the 3-pin male-to-female shroud power connector. It also features a fully moulded design for maximum durability and long life.

The female connector plugs directly into the device while the male connector plugs into another power cord, or auxiliary power port on power supply for auto power when the system is turned on.

Item #	Description
80626	2m BS 1363 to IEC60320 C19 Power Cord
80627	2m CEE 7/7 to IEC60320 C19 Power Cord
80649	2m SEV 1011 to IEC60320 C19 Power Cord



88511

16AWG UK POWER CORD (IEC 320 C13 TO BS 1363)

Replacement power cord for desktop PC, monitor, printer, scanner, etc.

This UK power cord is designed to work with most desktop PCs, monitors, scanners, printers, and other devices that use the 3-pin shroud power connector. This heavy duty 16AWG cord features a fully moulded design for maximum durability and long life. (Kettle Lead connector)

Item #	Description
88511	0.5m (IEC320 C13 to BS 1363) Power Cord
88512	1m (IEC320 C13 to BS 1363) Power Cord
88513	2m (IEC320 C13 to BS 1363) Power Cord
88514	3m (IEC320 C13 to BS 1363) Power Cord
88516	5m (IEC320 C13 to BS 1363) Power Cord
88517	10m (IEC320 C13 to BS 1363) Power Cord



88541

16AWG EUROPEAN POWER CORD (IEC 320 C13 TO CEE7/7)

Replacement power cord for desktop PC, monitor, printer, or scanner, etc.

One end of this power cord will work with most desktop PCs, monitors, scanners, printers, and other devices that use the 3-pin shroud power connector; the other end features a 2-prong Schuko European plug. This premium, heavy duty, 16AWG cord features a fully moulded design for maximum durability and long life. (Kettle Lead connector)



Item #	Description
88541	0.5m (IEC320 C13 to CEE7/7) Power Cord
88542	1m (IEC320 C13 to CEE7/7) Power Cord
88543	2m (IEC320 C13 to CEE7/7) Power Cord
88544	3m (IEC320 C13 to CEE7/7) Power Cord
88546	5m (IEC320 C13 to CEE7/7) Power Cord
88547	10m (IEC320 C13 to CEE7/7) Power Cord

88520

18AWG UK 90° POWER CORD (IEC 320 C13R TO BS 1363)

Great for confined areas, use this angled power cord for your desktop PC, monitor, printer, scanner, etc.

This universal power cord is ideal for tight areas and will plug into desktop PCs, monitors, scanners, printers, and other devices that use the 3-pin shroud power connector. This heavy duty 18AWG cord features a fully snagless design for maximum durability and long life. (Kettle Lead connector)

Item #	Description
88520	2m 90° (IEC320 C13R to BS 1363) Power Cord
88522	5m 90° (IEC320 C13R to BS 1363) Power Cord



80634

HOT CONDITION POWER CORDS AND EXTENSION CABLES

Power a network device in a data centre or network wiring closet

This power cord is the ideal solution for powering a network device or connecting to a PDU in a data centre or network wiring closet. This cable is able to support up to 250 volt connections and features 1.00mm² conductor construction. The fully molded design provides for maximum durability and long life.

Item #	Description
80634	2m 250 Volt Hot Condition Power Cord Extension (IEC C14 to IEC C15)
80637	2m 250 Volt Hot Condition Power Cord Extension (IEC C14 to IEC C15)
80638	2m 250 Volt Hot Condition European Power Cord (CEE 7/7 to IEC C15)
80639	2m 250 Volt Hot Condition Swiss Power Cord (SEV 1011 to IEC C15)



POWER CORDS

80642



GLOBAL POWER CORDS (IEC 60320 C13)

Replacement power cord for PC, monitor, printer, scanner, etc.

Providing you with power cords no matter where you are in the world. Designed to work with most desktop PCs, monitors, scanners, printers, and other devices that use the 3-pin shroud power connector (Kettle Lead). This heavy duty power cord features a fully moulded design for maximum durability and long life.

Item #	Description
80642	2m Swiss Power Cord (SEV 1011 to IEC320C13)
80652	2m Danish Power Cord (107-2-D1 DE1-13P to IEC320C13)
80662	2m Australian/New Zealand Power Cord (AS/NZS 3112 to IEC320C13)
80672	1.8m North American Power Cord (NEMA 5-15P to IEC320C13)
80682	2m South African Power Cord (SANS 164-2 to IEC320C13)

88534



16AWG EUROPEAN 90° POWER CORD (IEC 320 C13 TO CEE7/7)

Angled replacement power cord for desktop PC, monitor, printer, or scanner, etc.

One end of this power cord will work with most desktop PCs, monitors, scanners, printers, and other devices that use the 3-pin shroud power connector; the other end features a 2-prong Schuko European plug. The female connector plugs directly into device, while the male connector plugs into the standard European outlet. This premium, heavy duty, 16AWG cord features a fully moulded design for maximum durability and long life. (Kettle Lead connector)

Item #	Description
88534	2m 90° IEC320 C13 to CEE7/7 Power Cord
88536	5m 90° IEC320 C13 to CEE7/7 Power Cord

80628



UK POWER CORD SPLITTER (BS 1363 TO 2X C13)

An ideal solution for powering multiple devices with one outlet

This handy cable features a UK plug which splits to two female C13 shroud. Saves space by eliminating extra cords, and keeps your surge strip and UPS outlets from being blocked by bulky AC transformers. Ideal for use in compact workplaces or home offices where there is limited space for electronic equipment. This heavy duty 17AWG cord also features a fully moulded design for maximum durability and long life. Compatible for digital signage, power transformers, computers, monitors, scanners, printers, and other devices that use a 3-pin male shroud (C13), often called a Kettle Lead power connector.

Item #	Description
80628	3m BS 1363 to 2x C13 Power Cord Splitter

80629



EUROPEAN POWER CORD SPLITTER (CEE 7/7 TO 2X C13)

An ideal solution for powering multiple devices with one outlet

Replace your overused or misplaced power cable, or just manage your power more efficiently. Simply plug the power cord's male prong into a standard power outlet, and you're ready to power multiple electronic devices.

Saves space by eliminating extra cords. Ideal for use in compact workplaces or home offices where there is limited space for electronic equipment. This heavy duty 17AWG cord also features a fully moulded design for maximum durability and long life. Compatible for digital signage, power transformers, computers, monitors, scanners, printers, and other devices that use a 3-pin male shroud (C13), often called a Kettle Lead power connector.

Item #	Description
80629	3m CEE 7/7 to 2x C13 Power Cord Splitter

88501



18AWG COMPUTER POWER EXTENSION CORD (IEC 320 C13 TO IEC 320 C14)

Extend the length of your power cord for more flexibility

Make your work environment more flexible and efficient. This heavy duty 18AWG cord features a fully moulded design and works with monitors, scanners, printers, and other devices that use the 3-pin male-to-female shroud power connector. (Kettle Lead connector)

Item #	Description
88501	0.5m IEC320 C13 to IEC320 C14 Power Extension Cord
88502	1m IEC320 C13 to IEC320 C14 Power Extension Cord
88503	2m IEC320 C13 to IEC320 C14 Power Extension Cord
88504	3m IEC320 C13 to IEC320 C14 Power Extension Cord
88506	5m IEC320 C13 to IEC320 C14 Power Extension Cord

80630



AUSTRALIA/NEW ZEALAND POWER CORD SPLITTER (AS/NZS 3112 TO 2X C13)

An ideal solution for powering multiple devices with one outlet!

Replace your overused or misplaced power cable, or just manage your power more efficiently. This handy cable features an Australian/New Zealand plug which splits to two female C13 shroud. Simply plug the power cord's male prong into a standard power outlet, and you're ready to power multiple electronic devices.

Saves space by eliminating extra cords, and keeps your surge strip and UPS outlets from being blocked by bulky AC transformers.

Item #	Description
80630	3m Australia/New Zealand Power Cord Splitter (AS/NZS 3112 to 2x C13)

80631



1-TO-2 POWER CORD SPLITTER Y-CABLE (1 IEC 320 C14 TO 2 IEC 320 C13)

Turn one outlet into two while keeping your surge strips and UPS outlets free!

Replace your overused or misplaced power cable, or just manage your power more efficiently. This handy cable features a male 3-prong plug which splits to two female 3-prong shrouds. Simply plug the power cord's male prong into a standard outlet, and you're ready to power multiple electronic devices.

Saves space by eliminating extra cords, and keeps your surge strip and UPS outlets from being blocked by bulky AC transformers.

Item #	Description
80631	1.8m 1-to-2 Power Cord Splitter (1 IEC320C14 to 2 IEC320C13)

81137



16AWG 250 VOLT COMPUTER POWER EXTENSION CORD (IEC 320 C13 TO IEC 320 C14)

Extend the length of your current power cable for monitors, scanners, printers, and other devices that use a 3-pin shroud power connector

Plug in our power extension cord to make your work environment more flexible and efficient. The female connector plugs directly into device, and the male connector plugs into an existing cable. This heavy duty 16AWG cord features a fully moulded design for maximum durability and long life. Compatible for monitors, scanners, printers, and other devices that use a 3-pin shroud power connector. (Kettle Lead connector)

Item #	Description
81137	1.2m IEC320 C13 to IEC320 C14 Power Extension Cord

81138



14AWG COMPUTER POWER EXTENSION CORD (IEC 320 C13 TO IEC 320 C14)

Extend the length of your power cord for more flexibility

Make your work environment more flexible and efficient. This heavy duty 14AWG cord works with monitors, scanners, printers, and other devices that use the 3-pin male-to-female shroud power connector. Plus it features a fully moulded design for maximum durability and long life.

The female connector plugs directly into the device while the male connector plugs into another power cord, or auxiliary power port on power supply for auto power when the system is turned on. (Kettle Lead connector)

Item #	Description
81138	1.8m IEC320 C13 to IEC320 C14 Power Extension Cord

80571



14AWG 250 VOLT POWER CORD (IEC C14 TO IEC320 C19)

Power a server or connect a PDU in a data center or network wiring closet

This power cord is the ideal solution for powering a server or connecting to a PDU in a data center or network wiring closet. This cable is able to support up to 250 volt connections and features 14AWG conductor construction. The fully molded design provides for maximum durability and long life.

Item #	Description
80570	3FT 14AWG 250 Volt Power Cord (IEC C14 to IEC320 C19)
80571	6FT 14AWG 250 Volt Power Cord (IEC C14 to IEC320 C19)
80572	10FT 14AWG 250 Volt Power Cord (IEC C14 to IEC320 C19)

CUSTOM SOLUTIONS



RAPIDRUN®

RapidRun is the most complete audio/video cabling system—built from the ground up to save installation time, accommodate upgrades, and reduce the likelihood of return service calls due to faulty terminations.

RapidRun is a three-part (one runner, two break-aways), modular cabling solution that starts with a single runner cable that runs through walls, ceilings, and fixtures. Each runner cable supports multiple signal types such as VGA, Composite Video, S-Video, Component Video, HDMI, or DVI.

Each end of the runner cable is terminated with the appropriate flying lead or wall plate to connect to the system's source and display devices. Many configuration options are available to meet the needs of virtually any PC or audio/video application.

87114



RAPIDRUN VGA (HD15) + 3.5MM FLYING LEAD

Use with a Multi-Format runner for projectors and any display requiring a VGA and 3.5mm audio connection

RapidRun is designed to be the standard for in-wall audio/video installations. Using pre-terminated Break-away flying leads and wall plates with an in-wall runner ensures flexible, efficient, high quality connections for all types of equipment, with no field terminations.

Ideal for educational and institutional installations, this flying lead sends PC video and 3.5mm stereo audio over one cable. It is commonly used on the display (projector) end of classroom setups with the corresponding wall plate used at the teacher's station.

Item #	Description
87114	0.5m RapidRun VGA (HD15) + 3.5mm Flying Lead

87115



RAPIDRUN VGA (HD15) + 3.5MM + COMPOSITE VIDEO + STEREO AUDIO FLYING LEAD

Use with a Multi-Format runner for projectors and any display requiring an HD15, 3.5mm audio and RCA audio/video connection, RGB video, stereo audio, and digital signalling

RapidRun is designed to be the standard for in-wall audio/video installations. Using pre-terminated Break-away flying leads and wall plates with an in-wall runner ensures flexible, efficient, high quality connections for all types of equipment, with no field terminations.

Ideal for educational and institutional installations, this flying lead sends PC video, 3.5mm stereo audio and RCA composite audio/video over one cable. It is commonly used on the display (projector) end of classroom setups with the corresponding wall plate used at the teacher's station.

Item #	Description
87115	0.5m RapidRun VGA (HD15) + 3.5mm + Composite Video + Stereo Audio Flying Lead

87101



RAPIDRUN SINGLE GANG INTEGRATED VGA (HD15) + 3.5MM + RCA AUDIO/VIDEO WALL PLATE – BRUSHED ALUMINIUM

Use with a Multi-Format runner for projectors and any display requiring an HD15, 3.5mm audio and RCA audio/video connection

RapidRun is designed to be the standard for in-wall audio/video installations. Using pre-terminated Break-away flying leads and wall plates with an in-wall runner ensures flexible, efficient, high quality connections for all types of equipment, with no field terminations.

Ideal for educational and institutional installations, this wall plate receives PC video, 3.5mm stereo audio and RCA composite audio/video from one runner cable. Constructed from aluminium for durability, this wall plate has a locking connector that enables the integrator to save valuable space inside the surface mount or electrical box that typically is already packed with cables.

Item #	Description
87101	RapidRun Single Gang Integrated VGA (HD15) + 3.5mm + RCA Audio/Video Wall Plate – Brushed Aluminium

87105



RAPIDRUN DOUBLE GANG INTEGRATED VGA (HD15) + 3.5MM + COMPOSITE VIDEO + STEREO AUDIO + (2) KEYSTONE WALL PLATE – BRUSHED ALUMINIUM

Use with a Multi-Format runner for projectors and any display requiring an HD15, 3.5mm audio and RCA audio/video connection; the included keystones enable network or USB connectivity

Ideal for educational and institutional installations, this wall plate receives PC video, 3.5mm stereo audio and RCA composite audio/video from one runner cable. Constructed from aluminium for durability, this wall plate has a locking connector that enables the integrator to save valuable space inside the surface mount or electrical box that typically is already packed with cables. The included keystone bezels will work with most brands of keystone inserts including Leviton®, Lcom®, NetKey®, ADC Krone, HellermannTyton®, and Allen Tel.

Item #	Description
87105	RapidRun Double Gang Integrated VGA (HD15) + 3.5mm + Composite Video + Stereo Audio + (2) Keystone Wall Plate - Brushed Aluminium



87120

RAPIDRUN DOUBLE GANG INTEGRATED VGA (HD15) + 3.5MM + COMPOSITE VIDEO + STEREO AUDIO + HDMI + USB WALL PLATE – BRUSHED ALUMINIUM

Use with a Multi-Format runner for projectors and any display requiring an HD15, 3.5mm audio and RCA audio/video connection; the included HDMI and USB pigtails enable HD audio/video and data connectivity

Item #	Description
87120	RapidRun Double Gang Integrated VGA (HD15) +3.5mm + Composite Video + Stereo Audio + HDMI + USB Wall Plate – Brushed Aluminium

RapidRun is designed to be the standard for in-wall audio/video installations. Using pre-terminated Break-away flying leads and wall plates with an in-wall runner ensures flexible, efficient, high quality connections for all types of equipment, with no field terminations.

Ideal for educational and institutional installations, this wall plate receives PC video, 3.5mm stereo audio and RCA composite audio/video from one runner cable. Constructed from aluminium for durability, this wall plate has a locking connector that enables the integrator to save valuable space inside the surface mount or electrical box that typically is already packed with cables.

81308



84030



84042



KEYSTONE JACKS & INSERT MODULES

Keystone jacks and snap-in modules provide a full range of solutions for voice, home networking, home office, audio/video, and more

With the wide selection of jacks and snap-in modules we have, you can custom-configure your keystone wall plates and patch panels for greater control and more flexibility.

Item #	Description
81300	Snap-In USB A/B Female Keystone Insert Module - White
81302	Snap-In HDMI F/F Keystone Insert Module - White
81303	Snap-In Blank Keystone Insert Module - White
81307	Cat6 RJ45 UTP Keystone Jack - White
81308	90° Cat5e RJ45 UTP Keystone Jack - White
84000	Cat5e RJ45 UTP Keystone Jack - White
84030	180° Cat6 RJ45 UTP Keystone Jack - White
84042	Cat6 RJ45 UTP Toolless Keystone Jack - White

87107



RAPIDRUN MULTI-FORMAT RUNNER CABLE – CMG-RATED

Optimised for high density, multi-format signal applications over a single cable

RapidRun is designed to be the standard for in-wall audio/video installations. Using pre-terminated Break-away flying leads and wall plates with an in-wall runner ensures flexible, efficient, high quality connections for all types of equipment, with no field terminations.

Use this CMG-Rated Multi-Format runner for in-wall installations that support high density, multi-format applications. Whether hanging a projector in a modern 21st century classroom or installing a commercial digital signage system—a clean, crisp signal will be delivered every time.

Item #	Description
87107	3m RapidRun Multi-Format Runner Cable – CMG-Rated
87108	4m RapidRun Multi-Format Runner Cable – CMG-Rated
87109	7m RapidRun Multi-Format Runner Cable – CMG-Rated
87110	10m RapidRun Multi-Format Runner Cable – CMG-Rated
87111	15m RapidRun Multi-Format Runner Cable – CMG-Rated
87112	22m RapidRun Multi-Format Runner Cable – CMG-Rated
87113	30m RapidRun Multi-Format Runner Cable – CMG-Rated

87106



RAPIDRUN MULTI-FORMAT RUNNER CABLE (ORANGE) TEST ADAPTER CABLE

Check the continuity of a Multi-Format runner cable before sealing it in a wall

RapidRun is known for its versatility, convenience, and ease of installation—however, even the most experienced installers will run into hazards that damage or kink the cable during installation. Problems associated with installation damage are seldom found until the final phase of the installation when the cable is already enclosed in the wall. Colour-coded orange for use with RapidRun Multi-Format runners, this test adapter allows for a continuity test of the Multi-Format runner to ensure proper functionality before leaving the job site. This test adapter includes two pieces: a modified RapidRun connector that connects to the display end of the runner, and an RJ45 adapter cable that connects to source end of the runner and to the input of a common network cable tester.

Item #	Description
87106	0.3m RapidRun Multi-Format Runner Cable (Orange) Test Adapter Cable

87081



RAPIDRUN DESKTOP PC 15-PIN DIN (YELLOW & ORANGE) M/M COUPLER

Connect two RapidRun PC or Multi-Format runners together for quick solutions in the field

As projects are modified or upgrades are required, your customers deserve effective solutions to accommodate their existing cabling system. Now you can offer a RapidRun runner coupler that will connect two RapidRun runners together to customise the distance per your customer's needs. Use this coupler for RapidRun PC (yellow) or Multi-Format (orange) applications.

Item #	Description
87081	RapidRun Desktop PC 15-Pin Din (Yellow & Orange) M/M Coupler

87083



RAPIDRUN DESKTOP PC 15-PIN DIN (YELLOW & ORANGE) F/F COUPLER

Connect two RapidRun PC or Multi-Format flying leads together for a customised flying lead

This RapidRun female-to-female coupler is the solution to connect two RapidRun PC flying leads together without the need for a runner. The coupler acts as a very short runner cable that the user can easily customise patch cables in the field per the length required. Choose two PC or Multi-Format flying leads and this coupler and connect them all together to customise a flying lead from 3 to 20 feet in length.

Item #	Description
87083	RapidRun Desktop PC 15-Pin Din (Yellow & Orange) F/F Coupler

87088

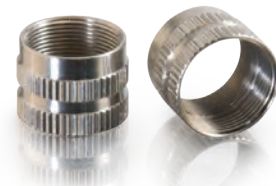

RAPIDRUN RUNNER COUPLING RINGS - 2PK

Replacement coupling rings for Desktop PC (yellow) and Multi-Format (orange) runners

Two coupling rings are provided with every Desktop PC (yellow) and Multi-Format (orange) RapidRun runner Cable for connecting break-away flying leads.

This 2-pack is available to replace those rings that are lost or misplaced.

Item #	Description
87088	RapidRun Runner Coupling Rings - 2pk

87103



RAPIDRUN PC (YELLOW) RUNNER TO MULTI-FORMAT (ORANGE) 15-PIN DIN ADAPTER

Adapt PC runner cables to Multi-Format (orange colour code) flying leads and wall plates

Adapt RapidRun PC (yellow) runner cables to Multi-Format (orange) flying leads and wall plates. Ideal for situations when replacing existing PC flying leads and wall plates with Multi-Format flying leads and wall plates.

If PC (yellow) flying leads/wall plates are used with a Multi-Format (orange) runner, then an adapter must be used on both ends of the runner cable. This adapter requires that a PC (yellow) flying lead/wall plate be used on both ends of the runner cable.

Item #	Description
87103	RapidRun PC (Yellow) Runner to Multi-Format (Orange) 15-Pin Din Adapter

87104



RAPIDRUN MULTI-FORMAT (ORANGE) RUNNER TO PC (YELLOW) 15-PIN DIN ADAPTER

Adapt Multi-Format runner cables to PC (yellow colour code) flying leads and wall plates

Adapt RapidRun Multi-Format (orange) runner cables to PC (yellow) flying leads and wall plates. Ideal for situations when existing PC flying leads and wall plates are desired with the installation of a Multi-Format runner.

If Multi-Format (orange) flying leads/wall plates are used with a PC (yellow) runner, then an adapter must be used on both ends of the runner cable. This adapter requires that a Multi-Format (orange) flying lead/wall plate be used on both ends of the runner cable.

Item #	Description
87104	RapidRun Multi-Format (Orange) Runner to PC (Yellow) 15-Pin Din Adapter



BID DESK SERVICE

FOR QUOTES & ORDERS
OVER £375/€450/\$500

WHAT IS THE BID DESK SERVICE?

C2G offers special bid pricing on quotes and orders over £375/€450/\$500. If you have a connectivity opportunity over £375/€450/\$500, contact your preferred distribution sales rep to discuss with them the details. Your C2G rep will work closely with distribution to secure special pricing and increase your chances to win the deal.

If you have a bid that is less than £375/€450/\$500 but represents a strategic opportunity, submit that and we can discuss a special bid for those opportunities as well.

WHAT INFORMATION IS NEEDED?

- The end user's details to log the bid to your organization.
- Whether the sku(s) are standard or custom.
- The reseller's target cost on the sku(s) to help in determining the discount.
- If known, the end user's target price for the sku(s).
- Is this part of a larger opportunity? If so, please explain.
- Who is the main competitor you are bidding against?
- What is the estimated close date?

HOW LONG DOES THE BID DESK PROCESS TAKE?

Typically, special bids are acknowledged and returned within 2 hours. If it's a custom built product, this timeframe may be extended as we require information from our offices in other countries and time zones. In addition, items that are not in stock or are backordered might have a longer processing time.

WHAT CUSTOMERS ARE SAYING

"The C2G bid support desk is one of the best in the business. The speed and quality of response for any quotes or assistance needed is second to none and enables us to give our customers the best possible experience. Being in the E-tail and SME spaces, it's vital we can be flexible and responsive to our customers' needs and we recognise how the C2G bid-desk is a big part of that offering."

Duncan Rutherford, Product Manager
dabs.com



BID DESK REQUEST FORM

FOR QUOTES & ORDERS OVER £375/€450/\$500

Now it's easier than ever to make your bid requests

DATE: _____

What currency is referenced on the form: _____

DISTRIBUTION INFORMATION

(Disty reps, please provide this form to your C2G rep)

Sales Rep: _____

Company: _____

Email Address: _____

RESELLER INFORMATION

(Resellers, please provide this form to your Disty rep)

Sales Rep: _____

Company: _____

Email Address: _____

END USER INFORMATION

(End Users, please provide this form to your Reseller rep)

Contact Name: _____

Company: _____

Email Address: _____

QUOTE/ORDER INFORMATION

Project Name: _____

Country of Use: _____

Sku No.	Sku Description	Qty.	Reseller's Target Cost per Sku	End User's Target Cost per Sku	Industry Standard Requirements - LSZH, RoHS,

Please see page 2 to input additional product sku information.

Is this part of a larger opportunity? If so, please explain: _____

Who is the main competitor the reseller is bidding against? _____

List any known product details about C2G competitors bidding for this opportunity: _____

What is the estimated close date? _____

What date are the products required by? _____

Is a sample required by the end user for any type of approval process prior to securing the order? _____

BID DESK REQUEST FORM

FOR QUOTES & ORDERS OVER £375/€450/\$500

Now it's easier than ever to make your bid requests

Sku No.	Sku Description	Qty.	Reseller's Target Cost per Sku	End User's Target Cost per Sku	Industry Standard Requirements - LSZH, RoHS,



Cable Connector Guide

A Group brand 

Mini DB / DB / Centronics / Micro Centronics Connectors



Lightning Connector



DVI Connectors



DIN / Mini-DIN (S-Video) Connectors



USB Connectors



Audio/Video Connectors



Firewire Connectors

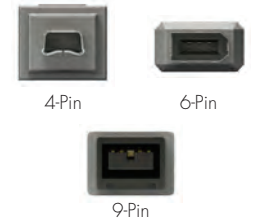

Modular Connectors



Fibre / Networking Connectors



Power Cords





Great King Street North
Birmingham, West Midlands B19 2LF
0 800 328 2916 (UK)
+44 (0)1952 677300 (EMEA)
www.c2g.com

Follow Us

