CATALOG

Sta-Kon® Power, connection & control

Wire termination & insulation



Thomas & Betts is now ABB Installation Products, but our long legacy of quality products and innovation remains the same. From connectors that help wire buildings on Earth to cable ties that help put machines in space, we continue to work every day to make, market, design and sell products that provide a smarter, safer and more reliable flow of electricity, from source to socket.

Table of contents

004–007	Overview
008–021	Ring terminals
022	Flag terminals
023–027	Fork terminals
027	Pin terminals
028–031	Splice connectors
032–034	Wire joints
035–036	Heat-shrinkable terminals, splices, disconnects
037–042	Disconnects and male tabs
045	Disconnects installation tool
043–044	Luminaire disconnects
046–051	Ferrules
052–067	Wire termination tools and installation kits
068–083	Wire termination technical information
084–096	Shrink-Kon[®] heat-shrinkable tubing
097–102	Shrink-Kon splice insulators and insulating covers
103–105	Shrink-Kon installation tools
106–120	Shield-Kon shield termination system
121–136	Dragon-Tooth[®] magnet wire termination system
137–146	Index

Overview

Experience the Sta-Kon[®] advantage

ABB developed the first tool-applied solderless terminals and connectors more than 70 years ago in response to industry awareness of the need for better performance of electrical systems.

Note: Listed for solid wire up to #10 AWG, terminals only.

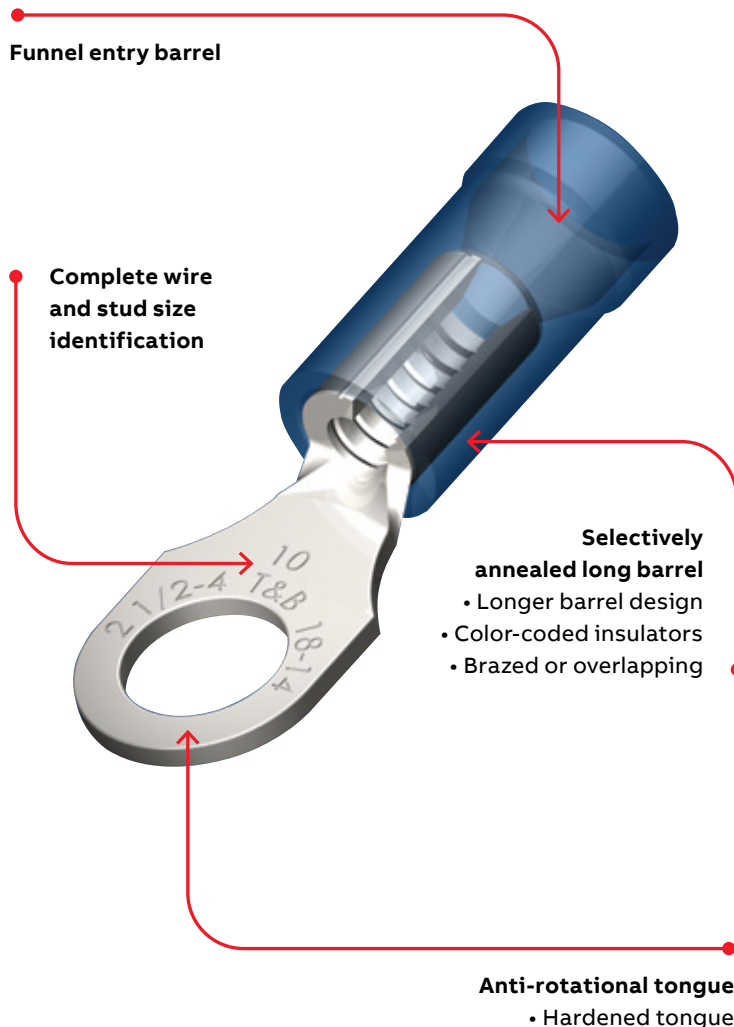

Key features and benefits

- Metal insulation grip sleeve is included on all-nylon terminal for strain relief
- Long barrel selectively annealed
- UL[®] listed E9809 unless otherwise specified

Deep internal serrations

After the insertion of a wire into the terminal's barrel, a deep, serrated interior ensures a large area of contact that lowers the resistance of a connection. With the mechanical force of the tool, the wire strands cold flow into the serrated interior. This guarantees electrical resistance lower than the wire to which it is applied. This feature also prevents pullout from vibration and mechanical strain. Deep internal serrations can be compared to the effective holding power of a well-treaded tire on a wet highway.

Funneled terminal barrel entry

This feature makes wire insertion faster and easier. A funneled barrel eliminates wire strand "hang up" upon insertion into the terminal's barrel. The loss of even a couple of wire strands can have negative results on electrical efficiency and resistance to mechanical strain.

Sta-Kon long barrel design

If lowering electrical resistance, preventing wire pullout, eliminating a "missed" crimp and having an insulator that stays on the barrel during installation are your goals, then you must design a terminal with a long barrel. This also provides the insulator with additional surface area, holding tight to the barrel. Most competitive barrel lengths range from 20–50% shorter than Sta-Kon terminals. The results are usually a stream of electrical failure, rework and added expense. Many competitive insulators come off during crimping due to a limited barrel length.

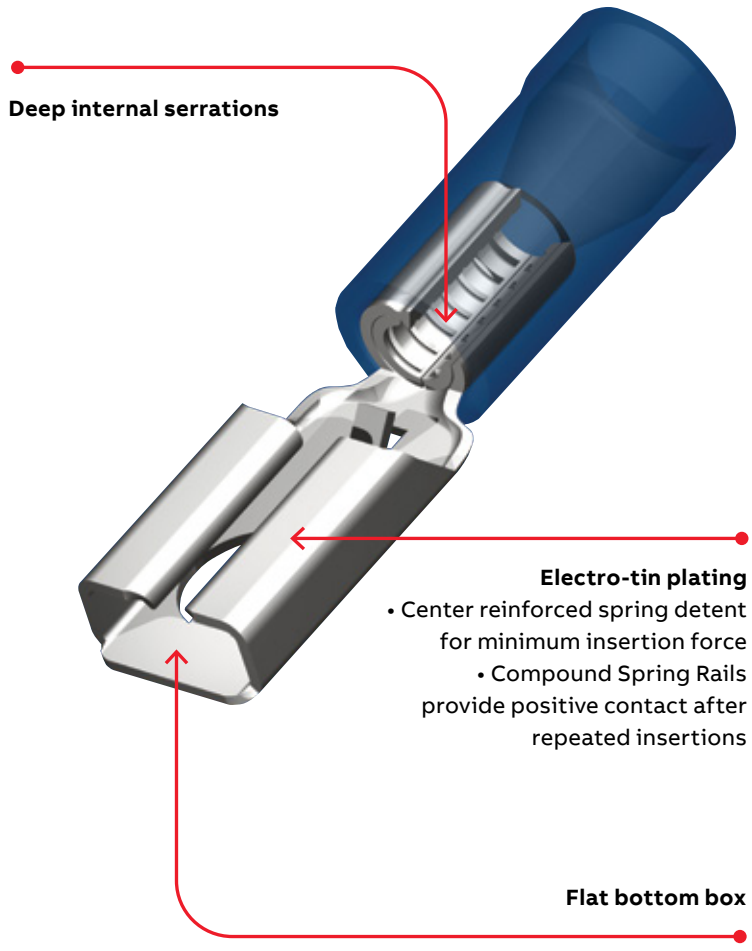

01 Strands enter as a homogeneous group and compact tightly under compression due to fully brazed seam.



01

Proper identification

We identify all terminals with ABB initials, ABB. We also indicate wire and stud sizes. These markings are clearly visible on the surface of the tongue, taking any guesswork out of replacing or reordering additional parts. Our superior bright plating also assists in visibility.

Superior terminals for superior connections

Brazed or overlapped seam

A long barrel design is of little value unless it is one solid piece. That is why ABB brazes the seam on our vinyl-insulated Sta-Kon® terminals and overlaps the seam on nylon-insulated terminals. Many competitive terminals have butted seams. This means increased chances for wire strand loss, poor resistance, wire pullout and electrical failure. If the installer doesn't position the tool exactly on the correct spot on the barrel, there's likely going to be an improper termination. The butted seam can also fold due to tool-applied pressure piercing the terminals insulation from the inside out. With ABB' brazed or overlapped seam, the installer can crimp anywhere along the barrel's surface. This provides up to 2.5 times the tensile strength of a butted seam terminal, guaranteeing proper electrical flow, void free.

Selective annealing

Because of the mechanical strength of copper, an installer can experience fatigue associated with repeated installations. For this reason, ABB puts its terminals through one more step called selective annealing. This process leaves the barrel soft enough to crimp and form around the wire. However, we "cold form" the tongue during the manufacturing process so it remains strong. This is done so the tongue can withstand repeated bends and bolt tightening strain common in most electrical installations. Many competitors attempt to accomplish similar goals by removing valuable material or using a softer copper, which has lower conductivity. This increases electrical resistance as well as the odds for shorting and downtime.

Anti-rotational tongues

This is a unique feature to the ABB ring tongue terminal. This design prevents terminal shorting by keeping the terminal secure in the terminal block. The installer can place a greater number of terminals closer together without worry.

All Sta-Kon terminals are deburred and degreased

To ensure a Sta-Kon terminal is properly plated and insulated, all our parts are put through a process that cleans and smooths the terminal of any manufacturing by-products – Mainly grease, oils and sharp edges. Many competitive products do not put their product through such rigorous finishing.

SUSTAINABLE DEVELOPMENT

Innovation, operational excellence and sustainable development are central to everything we do, reducing our environmental footprint and improving our communities.



Ring terminals

Nylon-insulated ring terminals

Note: Sta-Kon rings, forks and locking forks are tested and listed to UL 486A/B, two-way splices to UL 486C, disconnects to UL 310 and all applicable products to CSA 22.2.

Sta-Kon® rings, forks and locking forks

- Complete line of installing tools engineered to match tool with terminal
- First to gain military approval for pressure connections many styles available for military applications
- Sta-Kon products exceed test specification requirements of military, UL® and CSA



- Include extra metal sleeve to grip insulation
- Vinyl insulated and bare Sta-Kon terminals feature brazed seam wire barrels that can be crimped at any place on the barrel circumference
- Can be installed with crimping tools having a single indentor or double indentor (recommended for solid wire)
- Serrated barrel increases grip on wire
- Wire range identification on the tongue of each terminal
- Can be installed with crimping tools having a single indentor or double indentor (recommended for solid wire)
- Constructed of electrolytic copper for high conductivity
- Wire range identification on the tongue of each terminal

Nylon-insulated ring terminals



Cat. no.	Pkg. qty.	Wire range (AWG)	Max. ins. (in.)	Bolt hole (in.)	Rec. tool	Dimensions (in.)				Stock thick. (in.)
						A	B	C	M	
RZ22-2**	100	26-22	0.083	#2	ERG4006	0.57	0.14	0.13	0.49	0.02
RZ22-4**	100	26-22	0.083	#4		0.65	0.21	0.20	0.54	0.02
RZ22-6**	100	26-22	0.083	#6		0.65	0.21	0.20	0.54	0.02
RZ22-8**	100	26-22	0.083	#8		0.75	0.25	0.23	0.62	0.02
RZ22-10**	100	26-22	0.083	#10		0.75	0.25	0.23	0.62	0.02
RAX23*	1,000	26-24	0.125	#2	WT145A	0.66	0.14	0.14	0.59	0.02
RAX43*	1,000	26-24	0.125	#4		0.74	0.20	0.19	0.64	0.02
RAX63*	1,000	26-24	0.125	#6		0.84	0.25	0.22	0.72	0.02
RAX83*	1,000	26-24	0.125	#8		0.84	0.25	0.22	0.72	0.02
RAX103*	1,000	26-24	0.125	#10		0.84	0.25	0.24	0.72	0.02
RA18-4	100	22-16	0.136	#4	ERG4001	0.72	0.23	0.14	0.59	0.03
RA323	1,000	22-16	0.136	#4		0.72	0.23	0.14	0.59	0.03
RA333	1,000	22-16	0.136	#6		0.72	0.23	0.14	0.59	0.03
RA18-6	100	22-16	0.136	#6		0.86	0.26	0.25	0.71	0.03

* Not listed by UL or CSA

** CSA listed only

Cat. no.	Pkg. qty.	Wire range (AWG)	Max. ins. (in.)	Bolt hole (in.)	Rec. tool	Dimensions (in.)				Stock thick. (in.)
						A	B	C	M	
RA853	1,000	22-16	0.136	#6	WT145A	0.86	0.26	0.25	0.71	0.03
RA18-8	100	22-16	0.136	#8		0.89	0.26	0.25	0.71	0.03
RA833	1,000	22-16	0.136	#8		0.86	0.26	0.25	0.71	0.03
RA863	1,000	22-16	0.136	#8		0.89	0.26	0.25	0.71	0.03
RA18-10	100	22-16	0.136	#10		0.89	0.31	0.25	0.71	0.03
RA873	1,000	22-16	0.136	#10		0.89	0.31	0.25	0.71	0.03
RA18-14	100	22-16	0.136	¾		1.10	0.46	0.31	0.84	0.03
RA713	1,000	22-16	0.136	¾		1.10	0.46	0.31	0.84	0.03
RA18-516	100	22-16	0.136	5/16		1.10	0.46	0.31	0.84	0.03
RA723	1,000	22-16	0.136	5/16	ERG4001	1.10	0.46	0.31	0.84	0.03
RA18-38	100	22-16	0.136	¾		1.20	0.53	0.35	0.87	0.03
RA733	1,000	22-16	0.136	¾		1.20	0.53	0.35	0.87	0.03
RA18-12	100	22-16	0.136	½		1.30	0.72	0.50	0.92	0.03
RA753	1,000	22-16	0.136	½		1.30	0.72	0.50	0.92	0.03

Diagram

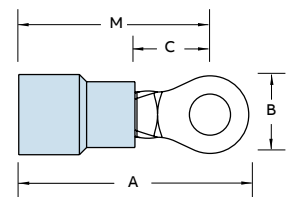

Ring terminals

Nylon-insulated ring terminals



Nylon-insulated ring terminals (continued)



Cat. no.	Pkg. qty.	Wire range (AWG)	Max. ins. (in.)	Bolt hole (in.)	Rec. tool	Dimensions (in.)				Stock thick. (in.)
						A	B	C	M	
RB14-4	100	18-14	0.162	#4	ERG4001	0.72	0.26	0.14	0.59	0.03
RB1323	1,000	18-14	0.162	#4		0.72	0.26	0.14	0.59	
RB14-6	100	18-14	0.162	#6		0.89	0.31	0.25	0.71	
RB853	1,000	18-14	0.162	#6		0.89	0.31	0.25	0.71	
RB1333	1,000	18-14	0.162	#6		0.74	0.26	0.14	0.59	
RB14-8	100	18-14	0.162	#8		0.89	0.31	0.25	0.71	
RB863	1,000	18-14	0.162	#8		0.89	0.31	0.25	0.71	
RB14-10	100	18-14	0.162	#10		0.89	0.31	0.25	0.71	
RB873	1,000	18-14	0.162	#10		0.89	0.31	0.25	0.71	
RB14-14	100	18-14	0.162	3/4		1.08	0.47	0.31	0.81	
RB713	1,000	18-14	0.162	3/4		1.08	0.47	0.31	0.81	
RB14-516	100	18-14	0.162	5/16		1.08	0.47	0.31	0.84	
RB723	1,000	18-14	0.162	5/16		1.08	0.47	0.31	0.84	
RB14-38	100	18-14	0.162	3/8		1.17	0.53	0.35	0.87	
RB733	1,000	18-14	0.162	3/8		1.17	0.53	0.35	0.87	
RB14-12	100	18-14	0.162	1/2		1.25	0.72	0.50	0.90	
RB753	1,000	18-14	0.162	1/2		1.25	0.72	0.50	0.90	
RC10-6	50	12-10	0.210	#6	ERG4001	1.00	0.37	0.27	0.81	0.04
RC333	500	12-10	0.210	#6		1.00	0.37	0.27	0.81	
RC10-8	50	12-10	0.210	#8		1.00	0.37	0.27	0.81	
RC863	500	12-10	0.210	#8		1.00	0.37	0.27	0.81	
RC10-10	50	12-10	0.210	#10		1.00	0.37	0.27	0.81	
RC363	500	12-10	0.210	#10		1.00	0.37	0.27	0.81	
RC10-14	50	12-10	0.210	3/4		1.12	0.53	0.32	0.86	
RC713	500	12-10	0.210	3/4		1.12	0.53	0.32	0.86	
RC10-516	50	12-10	0.210	5/16		1.21	0.53	0.31	0.94	
RC703	500	12-10	0.210	5/16		1.21	0.53	0.31	0.94	
RC10-38	50	12-10	0.210	3/8		1.27	0.59	0.35	0.98	
RC733	500	12-10	0.210	3/8		1.27	0.59	0.35	0.98	
RC10-12	50	12-10	0.210	1/2		1.37	0.72	0.52	1.02	
RC753	500	12-10	0.210	1/2		1.37	0.72	0.52	1.02	

Diagram

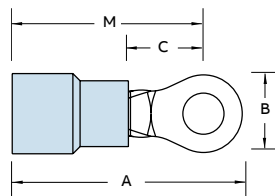

Nylon-insulated ring terminals - Expanded entry



Cat. no.	Pkg. qty.	Wire range (AWG)	Max. ins. (in.)	Bolt hole (in.)	Rec. tool	Dimensions (in.)				Stock thick. (in.)
						A	B	C	M	
RB14-4X	100	18-14	0.190	#4	ER4001	0.80	0.26	0.14	0.67	0.03
RB14-6X	100	18-14	0.190	#6		0.95	0.31	0.25	0.79	
RB854	1,000	18-14	0.190	#6		0.95	0.31	0.25	0.79	
RB14-8X	100	18-14	0.190	#8		0.95	0.31	0.25	0.79	
RB864	1,000	18-14	0.190	#8		0.95	0.31	0.25	0.79	
RB14-10X	100	18-14	0.190	#10		0.95	0.31	0.25	0.79	
RB874	1,000	18-14	0.190	#10		0.95	0.31	0.25	0.79	
RB14-14X	100	18-14	0.190	3/4		1.16	0.47	0.31	0.92	
RB714	1,000	18-14	0.190	3/4		1.16	0.47	0.31	0.92	
RB14-516X	100	18-14	0.190	5/16		1.16	0.47	0.31	0.92	
RB724	1,000	18-14	0.190	5/16		1.16	0.47	0.31	0.92	
RB14-38X	100	18-14	0.190	3/8		1.25	0.53	0.42	0.95	
RB734	1,000	18-14	0.190	3/8		1.25	0.53	0.42	0.95	
RC10-6X	50	12-10	0.250	#6	ERG4001	1.10	0.37	0.27	0.91	0.04
RC334	500	12-10	0.250	#6		1.10	0.37	0.27	0.91	
RC10-8X	50	12-10	0.250	#8		1.10	0.37	0.27	0.91	
RC864	500	12-10	0.250	#8		1.10	0.37	0.27	0.91	
RC10-10X	50	12-10	0.250	#10		1.10	0.37	0.27	0.91	
RC364	500	12-10	0.250	#10		1.10	0.37	0.27	0.91	
RC10-14X	50	12-10	0.250	3/4		1.22	0.53	0.32	0.96	
RC714	500	12-10	0.250	3/4		1.22	0.53	0.32	0.96	
RC10-516X	50	12-10	0.250	5/16		1.32	0.53	0.31	1.05	
RC704	500	12-10	0.250	5/16		1.32	0.53	0.31	1.05	
RC10-38X	50	12-10	0.250	3/8		1.38	0.59	0.48	1.09	
RC734	500	12-10	0.250	3/8		1.38	0.59	0.48	1.09	
RC10-12X	50	12-10	0.250	1/2		1.48	0.72	0.52	1.13	

Diagram

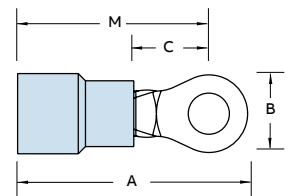

Ring terminals

Nylon-insulated large ring terminals



Nylon-insulated large ring terminals



Cat. no.	Wire Pkg. range qty. (AWG)	Max. ins. (in.)	Bolt hole (in.)	Rec. tool	Dimensions (in.)				Stock thick. (in.)	
					A	B	C	M		
Flex class 41/24										
RD167	200	8	0.340	#8	ERG4007	1.48	0.42	0.28	1.29	0.04
RD8-10	25	8	0.340	#10		1.48	0.42	0.28	1.29	
RD367	200	8	0.340	#10		1.48	0.42	0.28	1.29	
RD8-14	25	8	0.340	¼		1.54	0.46	0.36	1.32	
RD717	200	8	0.340	¼		1.54	0.46	0.36	1.32	
RD8-516	25	8	0.340	⅝ ₁₆		1.63	0.57	0.36	1.35	
RD727	200	8	0.340	⅝ ₁₆		1.63	0.57	0.36	1.35	
RD8-38	25	8	0.340	⅜		1.63	0.57	0.36	1.35	
RD737	200	8	0.340	⅜		1.63	0.57	0.36	1.35	
RD8-12*	25	8	0.310	½	TBM6S	1.79	0.82	0.55	1.39	
RD757*	200	8	0.310	½		1.79	0.82	0.55	1.39	
RD10161	200	8AN	0.270	#8	ERG4007	1.40	0.41	0.24	1.20	
RD10361	200	8AN	0.270	#10		1.40	0.41	0.24	1.20	
RD10711	200	8AN	0.270	¼		1.45	0.45	0.27	1.22	
RD10721	200	8AN	0.270	⅝ ₁₆		1.53	0.56	0.34	1.25	
RD10731	200	8AN	0.270	⅜		1.53	0.56	0.34	1.25	

*Braze seam
AN = Aircraft wire

Cat. no.	Wire Pkg. range qty. (AWG)	Max. ins. (in.)	Bolt hole (in.)	Rec. tool	Dimensions (in.)				Stock thick. (in.)	
					A	B	C	M		
Flex class 63/24										
RE6-10	20	6	0.420	#10	ERG4007	1.65	0.49	0.28	1.40	0.04
RE267	200	6	0.420	#10		1.65	0.49	0.28	1.40	
RE6-14	20	6	0.420	¼		1.65	0.49	0.28	1.40	
RE717	200	6	0.420	¼		1.65	0.49	0.28	1.40	
RE6-516	20	6	0.420	⅝ ₁₆		1.76	0.61	0.34	1.47	
RE727	200	6	0.420	⅝ ₁₆		1.76	0.61	0.34	1.47	
RE6-38	20	6	0.420	⅜		1.76	0.61	0.34	1.47	
RE737	200	6	0.420	⅜		1.76	0.61	0.34	1.47	
RE6-12*	20	6	0.395	½	TBM6S	1.83	0.82	0.55	1.43	
RE757*	200	6	0.395	½		1.83	0.82	0.55	1.43	
RE10261	200	6AN	0.315	#10	ERG4007	1.55	0.49	0.24	1.31	
RE10711	200	6AN	0.315	¼		1.55	0.49	0.27	1.31	
RE10721	200	6AN	0.315	⅝ ₁₆		1.70	0.60	0.34	1.40	
RE10731	200	6AN	0.315	⅜		1.70	0.60	0.34	1.40	
Flex class 105/24										
RF4-10	15	4	0.510	#10	TBM6S	1.76	0.56	0.36	1.49	0.04
RF267	100	4	0.510	#10		1.76	0.56	0.36	1.49	
RF4-14	15	4	0.510	¼		1.76	0.56	0.36	1.49	
RF717	100	4	0.510	¼		1.76	0.56	0.36	1.49	
RF4-516	15	4	0.510	⅝ ₁₆		1.84	0.62	0.35	1.53	
RF727	100	4	0.510	⅝ ₁₆		1.84	0.62	0.35	1.53	
RF4-38	15	4	0.510	⅜		1.84	0.62	0.35	1.53	
RF737	100	4	0.510	⅜		1.84	0.62	0.35	1.53	
RF757*	100	4	0.500	½		1.90	0.82	0.55	1.49	
RF10261	100	4AN	0.380	#10		1.78	0.55	0.30	1.51	
RF10711	100	4AN	0.380	¼		1.78	0.55	0.30	1.51	
RF10721	100	4AN	0.380	⅝ ₁₆		1.80	0.62	0.34	1.49	
RF10731	100	4AN	0.380	⅜		1.80	0.82	0.34	1.49	

Diagram

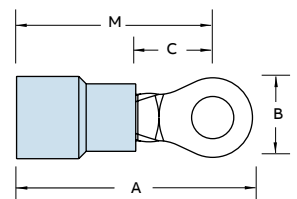

Ring terminals

Nylon-insulated large ring terminals



Nylon-insulated large ring terminals (continued)



Cat. no.	Pkg. qty.	Wire range (AWG)	Max. ins. (in.)	Bolt hole (in.)	Rec. tool	Dimensions (in.)				Stock thick. (in.)
						A	B	C	M	
Flex class 105/24										
RG2-10	10	2	0.588	#10	TBM6S	2.15	0.69	0.40	1.83	0.05
RG267	50	2	0.588	#10		2.15	0.69	0.40	1.83	
RG2-14	10	2	0.588	¼		2.15	0.69	0.40	1.83	
RG717	50	2	0.588	¼		2.15	0.69	0.40	1.83	
RG2-516	10	2	0.588	5/16		2.15	0.69	0.40	1.83	
RG727	50	2	0.588	5/16		2.15	0.69	0.40	1.83	
RG2-38	10	2	0.588	¾		2.15	0.69	0.40	1.83	
RG737	50	2	0.588	¾		2.15	0.69	0.40	1.83	
RG2-12	10	2	0.588	½		2.35	0.80	0.49	1.93	
RG757	50	2	0.588	½		2.35	0.80	0.49	1.93	
RG9711	50	2AN	0.453	¼		2.07	0.69	0.40	1.74	
RG9731	50	2AN	0.453	¾		2.07	0.69	0.40	1.74	
RG9751	50	2AN	0.453	½		2.26	0.80	0.49	1.84	
RH717	50	1/0	0.629	¼		2.14	0.77	0.43	1.81	0.05
RH727	50	1/0	0.629	5/16		2.14	0.77	0.43	1.81	
RH737	50	1/0	0.629	¾		2.14	0.77	0.43	1.81	
RH757	50	1/0	0.629	½		2.34	0.77	0.54	1.90	
RH9711	50	1AN	0.500	¼		2.14	0.77	0.44	1.81	
RH9731	50	1AN	0.500	¾		2.14	0.77	0.44	1.81	
RH9751	50	1AN	0.500	½		2.34	0.77	0.54	1.90	
RJ717	100	2/0	0.675	¼		2.34	0.83	0.46	1.96	0.06
RJ727	100	2/0	0.675	5/16		2.34	0.83	0.46	1.96	
RJ737	100	2/0	0.675	¾		2.34	0.83	0.46	1.96	
RJ757	100	2/0	0.675	½		2.48	0.89	0.54	2.03	
RJ9711	50	1/0AN	0.550	¼		2.35	0.83	0.46	1.97	
RJ9731	50	1/0AN	0.550	¾		2.35	0.83	0.46	1.97	
RJ9751	50	1/0AN	0.550	½		2.49	0.89	0.55	2.04	

Cat. no.	Pkg. qty.	Wire range (AWG)	Max. ins. (in.)	Bolt hole (in.)	Rec. tool	Dimensions (in.)				Stock thick. (in.)
						A	B	C	M	
Flex class 105/24										
RK717	25	3/0	0.765	¼	TBM6S	2.60	0.93	0.54	2.21	0.06
RK727	25	3/0	0.765	5/16		2.60	0.93	0.54	2.21	
RK737	25	3/0	0.765	¾		2.60	0.93	0.54	2.21	
RK9731	100	2/0AN	0.610	¾		2.52	0.93	0.55	2.14	
RK9751	100	2/0AN	0.610	½		2.60	0.93	0.55	2.15	
RL737	25	4/0	0.785	¾		2.83	1.04	0.57	2.35	0.07
RL757	25	4/0	0.785	½		2.83	1.04	0.57	2.35	
RL9731	25	3/0AN	0.680	¾		2.83	1.04	0.57	2.36	
RL9751	25	3/0AN	0.680	½		2.83	1.04	0.57	2.36	
RM737	20	250 kcmil	0.868	¾		3.00	1.13	0.65	2.51	0.07
RM747	20	250 kcmil	0.868	7/16		3.00	1.13	0.65	2.51	
RM757	20	250 kcmil	0.868	½		3.00	1.13	0.65	2.51	
RM9731	20	4/0AN	0.750	¾		3.00	1.13	0.66	2.51	
RM9751	20	4/0AN	0.750	½		3.00	1.13	0.66	2.51	

Diagram

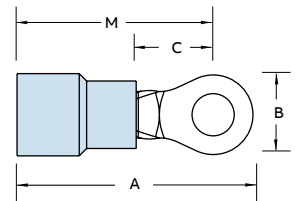

*Braze seam
AN = Aircraft wire

Ring terminals

Vinyl-insulated ring terminals



Extra-length PVC sleeve offers extra protection.

Vinyl-insulated ring terminals



Cat. no.	Wire Pkg. range (AWG)	Max. ins. (in.)	Bolt hole (in.)	Rec. tool	Dimensions (in.)				Stock thick. (in.)
					A	B	C	M	
18RA-4	100	22-16	0.150	#4 ERG4001	0.97	0.31	0.27	0.81	0.03
RA77	1,000	22-16	0.150	#4	0.97	0.31	0.27	0.81	0.03
18RA-6	100	22-16	0.150	#6	0.94	0.25	0.27	0.81	0.03
RA857	1,000	22-16	0.150	#6	0.94	0.25	0.27	0.81	0.03
18RA-8	100	22-16	0.150	#8	0.97	0.31	0.27	0.81	0.03
RA867	1,000	22-16	0.150	#8	0.97	0.31	0.27	0.81	0.03
18RA-10	100	22-16	0.150	#10	0.97	0.31	0.27	0.81	0.03
RA877	1,000	22-16	0.150	#10	0.97	0.31	0.27	0.81	0.03
18RA-14	100	22-16	0.150	1/4	1.13	0.50	0.37	0.88	0.03
RA717	1,000	22-16	0.150	1/4	1.13	0.50	0.37	0.88	0.03
18RA-516	100	22-16	0.150	5/16	1.13	0.50	0.37	0.88	0.03
RA727	1,000	22-16	0.150	5/16	1.13	0.50	0.37	0.88	0.03
18RA-38	100	22-16	0.150	3/8	1.24	0.54	0.37	0.91	0.03
RA737	1,000	22-16	0.150	3/8	1.24	0.54	0.37	0.91	0.03
14RB-4	100	18-14	0.170	#4	0.94	0.25	0.27	0.81	0.03
RB1327	1,000	18-14	0.170	#4	0.94	0.25	0.27	0.81	0.03
14RB-6	100	18-14	0.170	#6	0.97	0.31	0.27	0.81	0.03
RB857	1,000	18-14	0.170	#6	0.97	0.31	0.27	0.81	0.03
14RB-8	100	18-14	0.170	#8	0.97	0.31	0.27	0.81	0.03
RB867	1,000	18-14	0.170	#8	0.97	0.31	0.27	0.81	0.03
14RB-10	100	18-14	0.170	#10	0.97	0.31	0.27	0.81	0.03
RB877	1,000	18-14	0.170	#10	0.97	0.31	0.27	0.81	0.03
14RB-14	100	18-14	0.170	1/4	1.14	0.50	0.38	0.89	0.03
RB717	1,000	18-14	0.170	1/4	1.14	0.50	0.38	0.89	0.03
14RB-516	100	18-14	0.170	5/16	1.15	0.50	0.38	0.89	0.03
RB727	1,000	18-14	0.170	5/16	1.15	0.50	0.38	0.89	0.03
14RB-38	100	18-14	0.170	3/8	1.16	0.54	0.38	0.91	0.03
RB737	1,000	18-14	0.170	3/8	1.16	0.54	0.38	0.91	0.03

Cat. no.	Wire Pkg. range (AWG)	Max. ins. (in.)	Bolt hole (in.)	Rec. tool	Dimensions (in.)				Stock thick. (in.)
					A	B	C	M	
10RC-6	50	12-10	0.210	#6 ERG4001	1.06	0.31	0.27	0.90	0.04
RC337	500	12-10	0.210	#6	1.06	0.31	0.27	0.90	0.04
10RC-8	50	12-10	0.210	#8	1.06	0.31	0.27	0.90	0.04
RC777	500	12-10	0.210	#8	1.06	0.31	0.27	0.90	0.04
10RC-10	50	12-10	0.210	#10	1.06	0.31	0.27	0.90	0.04
RC367	500	12-10	0.210	#10	1.06	0.31	0.27	0.90	0.04
10RC-14	50	12-10	0.210	1/4	1.16	0.50	0.27	0.90	0.04
RC717	500	12-10	0.210	1/4	1.16	0.50	0.27	0.90	0.04
10RC-516	50	12-10	0.210	5/16	1.17	0.50	0.37	0.92	0.04
RC707	500	12-10	0.210	5/16	1.17	0.50	0.37	0.92	0.04
10RC-38	50	12-10	0.210	3/8	1.29	0.59	0.44	0.99	0.04
RC737	500	12-10	0.210	3/8	1.29	0.59	0.44	0.99	0.04

Diagram

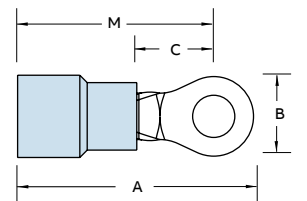

Ring terminals

Vinyl-insulated ring terminals – Expanded insulation



A wider wire entry for heavy-wall insulation.

Vinyl-insulated ring terminals – Expanded insulation

Cat. no.	Wire Pkg. range (AWG)	Max. ins. (in.)	Bolt hole (in.)	Rec. tool	Dimensions (in.)				Stock thick. (in.)	
					A	B	C	M		
18RA-4X	100	22-16	0.170	#4	ERG4001	10.97	0.31	0.27	0.81	0.03
18RA-6X	100	22-16	0.170	#6		0.97	0.31	0.27	0.81	0.03
18RA-8X	100	22-16	0.170	#8		0.97	0.31	0.27	0.81	0.03
18RA-38X	100	22-16	0.170	3/8		1.15	0.54	0.35	0.90	0.03
RA857-170	1,000	22-16	0.170	#6		0.97	0.31	0.27	0.81	0.03
RA867-170	1,000	22-16	0.170	#8		0.97	0.31	0.27	0.81	0.03
18RA-10X	1,000	22-16	0.170	#10		0.97	0.31	0.27	0.81	0.03
RA877-170	1,000	22-16	0.170	#10		0.97	0.31	0.27	0.81	0.03
18RA-14X	100	22-16	0.170	1/4		1.13	0.50	0.37	0.88	0.03
RA727-170	1,000	22-16	0.170	5/16		1.13	0.50	0.37	0.88	0.03
14RB-4X	100	18-14	0.200	#4		0.94	0.25	0.27	0.81	0.03
14RB-6X	100	18-14	0.200	#6		0.97	0.31	0.27	0.81	0.03
RB857-200	1,000	18-14	0.200	#6		0.97	0.31	0.27	0.81	0.03
14RB-8X	100	18-14	0.200	#8		0.97	0.31	0.27	0.81	0.03
RB867-200	1,000	18-14	0.200	#8		0.97	0.31	0.27	0.81	0.03
14RB-10X	100	18-14	0.200	#10		0.97	0.31	0.27	0.81	0.03
RB877-200	1,000	18-14	0.200	#10		0.97	0.31	0.27	0.81	0.03
14RB-14X	100	18-14	0.200	1/4		1.14	0.50	0.38	0.89	0.03
RB717-200	1,000	18-14	0.200	1/4		1.14	0.50	0.38	0.89	0.03
14RB-516X	100	18-14	0.200	5/16		1.15	0.50	0.38	0.89	0.03
14RB-38X	100	18-14	0.200	3/8		1.16	0.54	0.35	0.91	0.03

For multiple wire combinations per UL* file E9609, see page 14.



Cat. no.	Wire Pkg. range (AWG)	Max. ins. (in.)	Bolt hole (in.)	Rec. tool	Dimensions (in.)				Stock thick. (in.)	
					A	B	C	M		
10RC-6X	50	12-10	0.250	#6	ERG4001	1.06	0.31	0.27	0.90	0.04
RC337-250	500	12-10	0.250	#6		1.06	0.31	0.27	0.90	0.04
10RC-8X	50	12-10	0.250	#8		1.06	0.31	0.27	0.90	0.04
RC777-250	500	12-10	0.250	#8		1.06	0.31	0.27	0.90	0.04
10RC-10X	50	12-10	0.250	#10		1.06	0.31	0.27	0.90	0.04
RC367-250	500	12-10	0.250	#10		1.06	0.31	0.27	0.90	0.04
10RC-14X	50	12-10	0.250	1/4		1.16	0.50	0.27	0.90	0.04
RC717-250	500	12-10	0.250	1/4		1.16	0.50	0.27	0.90	0.04
10RC-516X	50	12-10	0.250	5/16		1.17	0.50	0.37	0.92	0.04
10RC-38X	50	12-10	0.250	3/8		1.29	0.59	0.44	0.99	0.04
RC737-250	500	12-10	0.250	3/8		1.29	0.59	0.44	0.99	0.04

Diagram

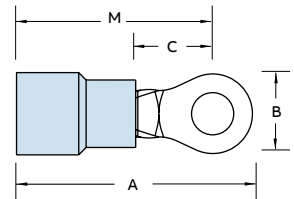

Ring terminals

Vinyl-insulated large ring terminals



Vinyl-insulated large ring terminals

Cat. no.	Wire range (AWG)	Max. ins. (in.)	Bolt hole (in.)	Rec. tool	Dimensions (in.)				Stock thick. (in.)
					A	B	C	M	
RDV167	8	0.340	#8	ERG4007	1.48	0.42	0.28	1.17	0.04
RDV367	8	0.340	#10		1.48	0.42	0.28	1.17	
RDV717	8	0.340	1/4		1.54	0.46	0.36	1.20	
RDV727	8	0.340	5/16		1.63	0.57	0.36	1.23	
RDV737	8	0.340	3/8		1.63	0.57	0.36	1.23	
RDV757*	8	0.310	1/2	TBM6S	1.79	0.82	0.55	1.27	

Vinyl-insulated large ring terminals (continued)

Cat. no.	Wire range (AWG)	Max. ins. (in.)	Bolt hole (in.)	Rec. tool	Dimensions (in.)				Stock thick. (in.)
					A	B	C	M	
REV267	6	0.420	#10	ERG4007	1.65	0.45	0.28	1.23	0.04
REV717	6	0.420	1/4		1.65	0.49	0.28	1.23	
REV727	6	0.420	5/16		1.76	0.61	0.34	1.30	
REV737	6	0.420	3/8		1.76	0.61	0.34	1.30	
REV757*	6	0.395	1/2	TBM6S	1.83	0.82	0.55	1.26	

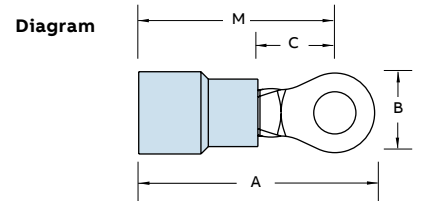

*Brazed seam

Multiple wire combinations listing per UL® file E9609

Recommended hand tools are WT145C and WT2000.

- No UL testing on disconnects for multiple wires
- No UL testing on nylon terminals for multiple wires
- No UL testing on non-insulated terminals for multiple wires

Type (insulation)	Wire range (AWG) each side
RA (vinyl) rings & forks	(1) #22 (1) #22 with (1) #20
RB (vinyl) rings & forks	(1) #16 with (1) #20 (2) #18 (1) #18 with (1) #20 (3) #20 (2) #20 (2) #20 with (2) #22 (1) #20 with (3) #22 (3) #22
RC (vinyl) rings & forks	(1) #12 with (1) #16 (1) #14 with (1) or (2) #16 (1) #14 with (1) or (2) #18 (2) #14 (3) #16 (2) #16 (1) #16 with (3) #18 (1) #16 with (2) #18 (1) #16 with (4) #18 (1) #16 with (3) #18

Type (insulation)	Wire range (AWG) each side
RCC (vinyl)	(1) #12 with (1) #16 (1) #14 with (1) or (2) #16 (1) #14 with (1) or (2) #18 (2) #14 (3) #16 (2) #16 (1) #16 with (3) #18 (1) #16 with (2) #18 (4) #18
RAA (vinyl)	(2) #22 (1) #22 with (1) #20
RBB (vinyl)	(1) #16 with (1) #20 (2) #18 (1) #18 with (1) #20 (3) #20 (2) #20 (2) #20 with (2) #22 (1) #20 with (3) #22 (3) #22

Ring terminals

Non-insulated ring terminals



Non-insulated ring terminals

Cat. no.	Pkg. qty.	Wire range (AWG)	Bolt hole (in.)	Rec. tool	Dimensions (in.)				Stock thick. (in.)
					A	B	C	M	
A18-4	100	22-16	#4	ERG4002	0.75	0.31	0.27	0.59	0.03
A18-6	100	22-16	#6		0.72	0.25	0.27	0.59	
A85	1,000	22-16	#6		0.72	0.25	0.27	0.59	
A18-8	100	22-16	#8		0.75	0.31	0.27	0.59	
A86	1,000	22-16	#8		0.75	0.31	0.27	0.59	
A18-10	100	22-16	#10		0.75	0.31	0.27	0.59	
A87	1,000	22-16	#10		0.75	0.31	0.27	0.59	
A18-14	100	22-16	1/4		0.92	0.50	0.37	0.67	
A71	1,000	22-16	1/4		0.92	0.50	0.37	0.67	
A18-516	100	22-16	5/16		0.92	0.50	0.37	0.67	
A72	1,000	22-16	5/16		0.92	0.50	0.37	0.67	
A18-38	100	22-16	3/8		0.99	0.54	0.35	0.67	
A73	1,000	22-16	3/8		0.99	0.54	0.35	0.67	
A18-12	100	22-16	1/2		1.06	0.72	0.38	0.70	
A75	1,000	22-16	1/2		1.06	0.72	0.38	0.70	
B14-4	100	18-14	#4	ERG4002	0.72	0.25	0.27	0.59	0.03
B132	1,000	18-14	#4	ERG4005	0.72	0.25	0.27	0.59	
B14-6	100	18-14	#6		0.72	0.25	0.27	0.59	
B133	1,000	18-14	#6		0.72	0.25	0.27	0.59	
B14-8	100	18-14	#8		0.75	0.31	0.27	0.59	
B86	1,000	18-14	#8		0.75	0.31	0.27	0.59	
B14-10	100	18-14	#10		0.75	0.31	0.27	0.59	
B87	1,000	18-14	#10		0.75	0.31	0.27	0.59	
B14-14	100	18-14	1/4		0.93	0.50	0.38	0.68	

Brazed seam

Constructed of electrolytic copper
for high conductivity!



Cat. no.	Pkg. qty.	Wire range (AWG)	Bolt hole (in.)	Rec. tool	Dimensions (in.)				Stock thick. (in.)
					A	B	C	M	
B71	1,000	18-14	1/4	ERG4002	0.93	0.50	0.38	0.68	0.03
B14-516	100	18-14	5/16	ERG4005	0.93	0.50	0.38	0.68	
B72	1,000	18-14	5/16		0.93	0.50	0.38	0.68	
B14-38	100	18-14	3/8		0.96	0.54	0.35	0.68	
B73	1,000	18-14	3/8		0.96	0.54	0.35	0.68	
B14-12	100	18-14	1/2		1.06	0.72	0.38	0.70	
B75-TB	1,000	18-14	1/2		1.06	0.72	0.38	0.70	
B85	1,000	18-14	#6		0.75	0.31	0.27	0.59	
B134	1,000	18-14	#8		0.72	0.25	0.27	0.59	
C10-6-SK	50	12-10	#6		0.82	0.31	0.27	0.66	0.04
C33	500	12-10	#6		0.82	0.31	0.27	0.66	
C10-8-SK	50	12-10	#8		0.82	0.31	0.27	0.66	
C77	500	12-10	#8		0.82	0.31	0.27	0.66	
C10-10	50	12-10	#10		0.85	0.38	0.27	0.66	
C26	500	12-10	#10		0.85	0.38	0.27	0.66	
C36	500	12-10	#10		0.82	0.31	0.27	0.66	
C10-14	50	12-10	1/4		0.91	0.50	0.27	0.66	
C71	500	12-10	1/4		0.91	0.50	0.27	0.66	
C10-516	50	12-10	5/16		0.98	0.50	0.38	0.73	
C70	500	12-10	5/16		0.98	0.50	0.38	0.73	
C72	500	12-10	5/16		1.10	0.59	0.45	0.80	
C10-38	50	12-10	3/8		1.10	0.59	0.45	0.80	
C73	500	12-10	3/8		1.10	0.59	0.45	0.80	
C10-12	50	12-10	1/2		1.21	0.72	0.38	0.84	
C75	500	12-10	1/2		1.21	0.72	0.38	0.84	

Diagram

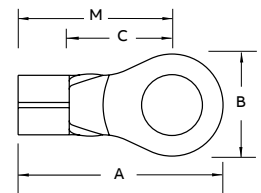

Ring terminals

Non-insulated large ring terminals – Brazed seam



Non-insulated large ring terminals – Brazed seam



Cat. no.	Pkg. qty.	Wire range (AWG)	Bolt hole (in.)	Rec. tool	Dimensions (in.)				Stock thick. (in.)	
					A	B	C	M		
D8-10	25	8	#10	TBM6S	1.09	0.42	0.34	0.90	0.06	
D36	200	8	#10		1.09	0.42	0.34	0.90		
D26	200	8	#10		1.13	0.48	0.36	0.90		
D8-14-SK	25	8	1/4		1.13	0.48	0.36	0.90		
D71	200	8	1/4		1.13	0.48	0.36	0.90		
D8-516	25	8	5/16		1.32	0.59	0.49	1.03		
D72	200	8	5/16		1.32	0.59	0.49	1.03		
D8-38	25	8	3/8		1.32	0.59	0.49	1.03		
D73	200	8	3/8		1.32	0.59	0.49	1.03		
D8-12	25	8	1/2		1.49	0.82	0.55	1.09		
D75	200	8	1/2		1.49	0.82	0.55	1.09		
E6-10	20	6	#10		1.13	0.48	0.36	0.90		0.06
E26	200	6	#10		1.13	0.48	0.36	0.90		
E6-14	20	6	1/4		1.13	0.48	0.36	0.90		
E71	200	6	1/4		1.13	0.48	0.36	0.90		
E6-516	20	6	5/16		1.32	0.60	0.49	1.03		

Cat. no.	Pkg. qty.	Wire range (AWG)	Bolt hole (in.)	Rec. tool	Dimensions (in.)				Stock thick. (in.)
					A	B	C	M	
E72	200	6	5/16	TBM6S	1.32	0.60	0.49	1.03	0.06
E6-38	20	6	3/8		1.32	0.60	0.49	1.03	
E73	200	6	3/8		1.32	0.60	0.49	1.03	
E6-12	20	6	1/2		1.49	0.82	0.55	1.08	
E75	200	6	1/2		1.49	0.82	0.55	1.08	
F4-10	20	4	#10		1.16	0.48	0.36	0.93	0.07
F26	200	4	#10		1.16	0.48	0.36	0.93	
F4-14	20	4	1/4		1.16	0.48	0.36	0.93	
F71-TB	200	4	1/4		1.16	0.48	0.36	0.93	
F4-516	20	4	5/16		1.35	0.60	0.49	1.06	
F72	200	4	5/16		1.35	0.60	0.49	1.06	
F4-38	20	4	3/8		1.35	0.60	0.49	1.06	
F73	200	4	3/8		1.35	0.60	0.49	1.06	
F4-12	20	4	1/2		1.52	0.82	0.55	1.11	
F75	200	4	1/2		1.52	0.82	0.55	1.11	

Diagram

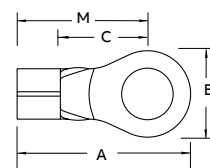

Ring Terminals

Non-insulated large ring terminals – Tubular



Select the configuration you need!

Non-insulated large ring terminals – Tubular



Cat. no.	Pkg. qty.	Wire range (AWG)	Bolt hole (in.)	Rec. tool	Dimensions (in.)				Stock thick. (in.)
					A	B	C	M	
D10161	200	8/8AN	#8	ERG 4005 ERG 4008	1.15	0.41	0.28	0.95	0.04
D10361	200	8/8AN	#10		1.15	0.41	0.28	0.95	
D10711	200	8/8AN	1/4		1.20	0.45	0.36	0.97	
D10721	200	8/8AN	5/16		1.28	0.56	0.36	1.00	
D10731	200	8/8AN	3/8		1.28	0.56	0.36	1.00	
D975*	200	8/8AN	1/2	TBM6S	1.46	0.83	0.49	1.06	
E10261	200	6/6AN	#10	ERG 4005 ERG 4008	1.26	0.49	0.24	1.02	0.04
E10711	200	6/6AN	1/4		1.26	0.49	0.27	0.99	
E10721	200	6/6AN	5/16		1.38	0.60	0.34	1.04	
E10731	200	6/6AN	3/8		1.38	0.60	0.34	1.04	
F10261	100	4/4AN	#10	ERG 4008	1.37	0.55	0.30	1.07	0.04
F10711	100	4/4AN	1/4		1.37	0.55	0.30	1.07	
F10721	100	4/4AN	5/16		1.42	0.62	0.34	1.08	
F10731	100	4/4AN	3/8		1.42	0.62	0.34	1.08	
F975*	200	4/4AN	1/2	TBM6S	1.49	0.83	0.45	1.10	
G926	100	2/2AN	#10	ERG 4008 TBM6S	1.59	0.69	0.40	1.26	0.04
G2-14	10	2/2AN	1/4		1.59	0.69	0.40	1.26	
G971	100	2/2AN	5/16		1.59	0.69	0.40	1.26	
G2-516	10	2/2AN	5/16		1.59	0.69	0.40	1.26	
G972	100	2/2AN	5/16		1.59	0.69	0.40	1.26	
G2-38	10	2/2AN	3/8		1.59	0.69	0.40	1.26	
G973	100	2/2AN	3/8		1.59	0.69	0.40	1.26	
G2-12	10	2/2AN	1/2		1.79	0.80	0.49	1.36	
G975	100	2/2AN	1/2		1.79	0.80	0.49	1.36	

*Braze seam.
AN – Aircraft wire

Cat. no.	Pkg. qty.	Wire range (AWG)	Bolt hole (in.)	Rec. tool	Dimensions (in.)				Stock thick. (in.)
					A	B	C	M	
H10-14	10	1AN-1/0	1/4	ERG 4008 TBM6S	1.65	0.77	0.43	1.32	0.05
H971	100	1AN-1/0	1/4		1.65	0.77	0.43	1.32	
H972	100	1AN-1/0	5/16		1.65	0.77	0.43	1.32	
H973	100	1AN-1/0	3/8		1.65	0.77	0.43	1.32	
H975	100	1AN-1/0	1/2		1.85	0.77	0.54	1.41	
J971	50	1/0AN-2/0	1/4	TBM6S	1.94	0.84	0.48	1.53	0.06
J972	50	1/0AN-2/0	5/16		1.94	0.84	0.48	1.53	
J20-38	10	1/0AN-2/0	3/8		1.84	0.83	0.46	1.46	
J973	50	1/0AN-2/0	3/8		1.99	0.84	0.53	1.58	
J974	50	1/0AN-2/0	7/16		1.99	0.89	0.51	1.56	
J975	50	1/0AN-2/0	1/2		1.99	0.89	0.51	1.56	
J976	50	1/0AN-2/0	5/8		1.99	0.89	0.51	1.56	
K971	50	2/0AN-3/0	1/4		2.08	0.93	0.54	1.69	0.06
K972	50	2/0AN-3/0	5/16		2.08	0.93	0.54	1.69	
K30-38	5	2/0AN-3/0	3/8		2.08	0.93	0.54	1.69	
K973	50	2/0AN-3/0	3/8		2.08	0.93	0.54	1.69	
K974	50	2/0AN-3/0	7/16		2.08	0.93	0.54	1.70	
K975	50	2/0AN-3/0	1/2		2.08	0.93	0.54	1.70	
L971	50	3/0AN-4/0	1/4		2.25	1.04	0.57	1.77	0.07
L972	50	3/0AN-4/0	5/16		2.25	1.04	0.57	1.77	
L40-38	5	3/0AN-4/0	3/8		2.25	1.04	0.57	1.77	
L973	50	3/0AN-4/0	3/8		2.25	1.04	0.57	1.77	
L974	50	3/0AN-4/0	7/16		2.25	1.04	0.57	1.77	
L975	50	3/0AN-4/0	1/2		2.25	1.04	0.57	1.77	
M972	50	4/0AN-250 kcmil	5/16		2.28	1.12	0.62	1.90	0.07
M250-38	5	4/0AN-250 kcmil	3/8		2.40	1.12	0.65	1.91	
M973	50	4/0AN-250 kcmil	3/8		2.40	1.12	0.65	1.91	
M974	50	4/0AN-250 kcmil	7/16		2.40	1.12	0.65	1.91	
M975	50	4/0AN-250 kcmil	1/2		2.40	1.12	0.65	1.91	

Diagram

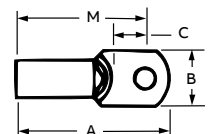

Ring terminals

Insulated heavy-duty ring terminals



Insulated heavy-duty ring terminals



Cat. no.	Pkg. qty.	Wire range (AWG)	Max. ins. (in.)	Bolt hole (in.)	Rec. tool	Dimensions (in.)				Stock thick. (in.)
						A	B	C	M	
Nylon										
RBC14-6	50	16-14 Heavy-duty	0.210	#6	WT2130A	0.98	0.25	0.29	0.85	0.05
RBC14-8	50		0.210	#8		1.04	0.39	0.29	0.85	
RBC863	500		0.210	#8		1.04	0.39	0.29	0.85	
RBC14-10	50		0.210	#10		1.04	0.39	0.29	0.85	
RBC14-14	50		0.210	¼		1.10	0.51	0.29	0.85	
RBC713	500		0.210	¼		1.10	0.51	0.29	0.85	
RBC14-516	50		0.210	5/16		1.21	0.54	0.38	0.94	
RBC14-38	50		0.210	¾		1.26	0.63	0.38	0.94	
RBC14-12	50		0.210	½		1.49	0.76	0.54	1.11	
RBC753	500		0.210	½		1.49	0.76	0.54	1.11	
Vinyl										
14RBC-6	50	16-14 Heavy-duty	0.210	#6	WT2130A	1.06	0.25	0.29	0.93	0.05
RBC857	500		0.210	#6		1.06	0.25	0.29	0.93	
14RBC-8	50		0.210	#8		1.13	0.39	0.29	0.93	
RBC867	500		0.210	#8		1.13	0.39	0.29	0.93	
14RBC-10	50		0.210	#10		1.13	0.39	0.29	0.93	
RBC877	500		0.210	#10		1.13	0.39	0.29	0.93	
14RBC-14	50		0.210	¼		1.19	0.51	0.29	0.93	
RBC717	500		0.210	¼		1.19	0.51	0.29	0.93	
14RBC-516	50		0.210	5/16		1.29	0.54	0.38	1.03	
RBC727	500		0.210	5/16		1.29	0.54	0.38	1.03	
14RBC-38	50		0.210	¾		1.34	0.63	0.38	1.03	
RBC797	500		0.210	¾		1.34	0.63	0.38	1.03	
14RBC-12	50		0.210	½		1.57	0.76	0.54	1.19	
RB757	500		0.210	½		1.57	0.76	0.54	1.19	

Diagram

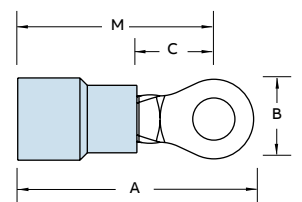

Ring terminals

Non-insulated heavy-duty ring terminals



The heavy-duty terminal solution!

Non-insulated heavy-duty ring terminals



Cat. no.	Pkg. qty.	Wire range (AWG)	Bolt hole (in.)	Rec. tool	Dimensions (in.)				Stock thick. (in.)
					A	B	C	M	
BC14-6	50	16-14 Heavy-duty	#6	ER4002	0.81	0.25	0.29	0.68	0.05
BC85	500		#6	ERG4005	0.81	0.25	0.29	0.68	
BC14-8	50		#8		0.87	0.39	0.29	0.68	
BC86	500		#8		0.87	0.39	0.29	0.68	
BC14-10	50		#10		0.87	0.39	0.29	0.68	
BC87	500		#10		0.87	0.39	0.29	0.68	
BC14-14	50		1/4		0.93	0.51	0.29	0.68	
BC71	500		1/4		0.93	0.51	0.29	0.68	
BC14-516	50		5/16		1.04	0.54	0.38	0.77	
BC72	500		5/16		1.04	0.54	0.38	0.77	
BC14-38	50		3/8		1.09	0.63	0.38	0.77	
BC79	500		3/8		1.09	0.63	0.38	0.77	
BC14-12	50		1/2		1.32	0.76	0.54	0.94	
BC75	500		1/2		1.32	0.76	0.54	0.94	

Diagram

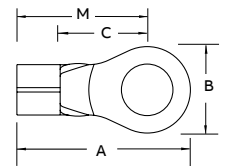

Ring terminals

High-temperature non-insulated rings – 1200 °F max.
& Tefzel® insulated rings – Insulation grip



High-temperature non-insulated rings – 1200 °F max.

Cat. no.	Wire Pkg. range	Wt./lbs. per 1,000	Bolt per hole (in.)	Rec. tool	Dimensions (in.)				Stock thick. (in.)
					A	B	C	M	
NW18-10	100 20-18	2.5	#10	WT1377	0.63	0.31	0.28	0.38	0.032
NW52	1,000 20-18	2.5	#8		0.63	0.31	0.28	0.38	
NW81	1,000 16-14	2.5	#6		0.66	0.31	0.28	0.51	0.040
NW14-8	100 16-14	2.5	#8		0.66	0.31	0.28	0.51	
NW14-10	100 16-14	2.5	#10		0.66	0.31	0.28	0.51	
NW83	1,000 16-14	2.5	#10		0.66	0.31	0.28	0.51	
NW14-12	100 16-14	2.5	#12*		0.66	0.31	0.28	0.51	
NW84	1,000 16-14	2.5	#12*		0.66	0.31	0.28	0.51	
NW10-8	50 12-10	3	#8		0.66	0.31	0.28	0.51	0.040
NW10-10	50 12-10	3	#10		0.66	0.31	0.28	0.51	
NW10-12	50 12-10	3	#12*		0.66	0.31	0.28	0.51	

Diagram

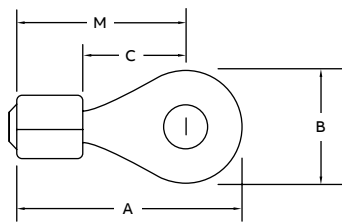

* #12 stud is smaller than 1/4" stud.

Terminals for nichrome wire NW series.



Tefzel insulated rings – Insulation grip



Cat. no.	Wire Pkg. range	Max. Ins. (in.)	Bolt hole (in.)	Rec. tool	Dimensions (in.)				Stock thick. (in.)
					A	B	C	M	
RAT853	1,000 22-18	0.140	#6	WT145C	0.81	0.25	0.25	0.69	0.03
RAT863	1,000 22-18	0.140	#8		0.84	0.31	0.25	0.69	
RAT873	1,000 22-18	0.140	#10		0.84	0.31	0.25	0.69	
RAT713	1,000 22-18	0.140	1/4		1.07	0.46	0.31	0.84	
RBT853	1,000 16-14	0.170	#6		0.84	0.31	0.25	0.69	0.03
RBT863	1,000 16-14	0.170	#8		0.84	0.31	0.25	0.69	
RBT873	1,000 16-14	0.170	#10		0.84	0.31	0.25	0.69	
RBT713	1,000 16-14	0.170	1/4		1.08	0.46	0.31	0.81	
RCT333	500 12-10	0.210	#6		1.00	0.37	0.27	0.81	0.04
RCT863	500 12-10	0.210	#8		1.00	0.37	0.27	0.81	
RCT363	500 12-10	0.210	#10		1.00	0.37	0.27	0.81	
RCT713	500 12-10	0.210	1/4		1.11	0.52	0.32	0.85	
RCT703	500 12-10	0.210	5/16		1.23	0.52	0.31	0.96	
RCT733	500 12-10	0.210	3/8		1.29	0.58	0.35	1.00	

Diagram

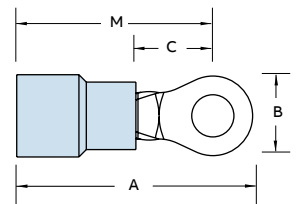

Tefzel is a registered trademark of DuPont.

Ring terminals

Nylon-insulated rectangular rings & non-insulated rectangular rings



Nylon-insulated rectangular rings



Cat. no.	Pkg. qty.	Wire range hole (AWG)	Rec. tool	Dimensions (in.)				Bu-ships tongue shape	Stock thick. (in.)
				A	B	C	M		
RA486	1,000	#4 22-18	ERG4001	0.796	0.237	0.237	0.143	L86P-1	0.03
RA485	1,000	#4 22-18		1.015	0.237	0.404	0.195	L85P-1	
RA483	1,000	#5 22-18		0.859	0.277	0.277	0.143	L83P-1	
RA484	1,000	#6 22-18		1.015	0.237	0.404	0.195	L84P-1	
RA481	1,000	#6 22-18		1.109	0.302	0.465	0.227	L81P-1	
RA482	1,000	#8 22-18		1.109	0.302	0.465	0.227	L82P-1	
RA480*	1,000	#8 22-18		1.359	0.390	0.621	0.310	L80P-1	
RB486	1,000	#4 16-14		0.796	0.237	0.237	0.143	L86P-2	0.03
RB485	1,000	#4 16-14		1.015	0.237	0.404	0.195	L85P-2	
RB483	1,000	#5 16-14		0.859	0.277	0.277	0.143	L83P-2	
RB484	1,000	#6 16-14		1.015	0.237	0.404	0.195	L84P-2	
RB481	1,000	#6 16-14		1.109	0.302	0.465	0.227	L81P-2	
RB482	1,000	#8 16-14		1.109	0.302	0.465	0.227	L82P-2	
RB480*	1,000	#8 16-14		1.359	0.390	0.621	0.310	L80P-2	
RC486	500	#4 12-10		0.984	0.237	0.237	0.143	L86P-3	0.04
RC485	500	#4 12-10		1.187	0.237	0.404	0.195	L85P-3	
RC483	500	#5 12-10		1.046	0.277	0.277	0.143	L83P-3	
RC484	500	#6 12-10		1.203	0.237	0.404	0.195	L84P-3	
RC481	500	#6 12-10		1.281	0.302	0.465	0.227	L81P-3	
RC482	500	#8 12-10		1.281	0.302	0.465	0.227	L82P-3	
RC480*	500	#8 12-10		1.531	0.390	0.621	0.310	L80P-3	

Diagram

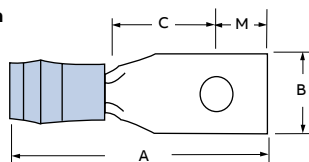

* Not available on tape.

Note: RA, RB, RC486 for use with BU-Ships terminal board types 26TB. RA, RB, RC485 for use with 25TB and 27TB. RA, RB, RC483 for use with 8TB. RA, RB, RC484 for use with 10TB and 11TB. RA, RB, RC481 for use with 6TB, 7TB and 9TB. RA, RB, RC482 for use with 15TB. RA, RB, RC480 for use with 3TB, 4TB, 5TB, 16TB, 17TB and 18TB.

Note:

22-18 ga. = 1-2 Navy
16-14 ga. = 2½-4 Navy
12-10 ga. = 6-9 Navy

The heavy-duty terminal solution!



Non-insulated rectangular rings



Cat. no.	Pkg. qty.	Wire range hole (AWG)	Rec. tool	Dimensions (in.)				Bu-ships tongue shape	Stock thick. (in.)
				A	B	C	M		
A486	1,000	#4 22-18	ERG4002	0.65	0.237	0.237	0.143	L86	0.03
A485	1,000	#4 22-18		0.87	0.237	0.404	0.195	L85	
A483	1,000	#5 22-18		0.70	0.277	0.277	0.143	L83	
A484	1,000	#6 22-18		0.87	0.237	0.404	0.195	L84	
A481	1,000	#6 22-18		0.96	0.302	0.465	0.227	L81	
A482	1,000	#8 22-18		0.96	0.302	0.465	0.227	L82	
A480*	1,000	#8 22-18		1.21	0.390	0.621	0.310	L80	
B486	1,000	#4 16-14	ERG4002	0.65	0.237	0.237	0.143	L86	0.03
B485	1,000	#4 16-14	ERG4005	0.87	0.237	0.404	0.195	L85	
B483	1,000	#5 16-14		0.70	0.277	0.277	0.143	L83	
B484	1,000	#6 16-14		0.87	0.237	0.404	0.195	L84	
B481	1,000	#6 16-14		0.96	0.302	0.465	0.227	L81	
B482	1,000	#8 16-14		0.96	0.302	0.465	0.227	L82	
B480*	1,000	#8 16-14		1.21	0.390	0.621	0.310	L80	
C486	500	#4 12-10		0.73	0.237	0.237	0.143	L86	0.04
C485	500	#4 12-10		0.90	0.237	0.404	0.195	L85	
C483	500	#5 12-10		0.76	0.277	0.277	0.143	L83	
C484	500	#6 12-10		0.94	0.237	0.404	0.195	L84	
C481	500	#6 12-10		1.03	0.302	0.465	0.227	L81	
C482	500	#8 12-10		1.03	0.302	0.465	0.227	L82	
C480*	500	#8 12-10		1.27	0.390	0.621	0.310	L80	

Diagram

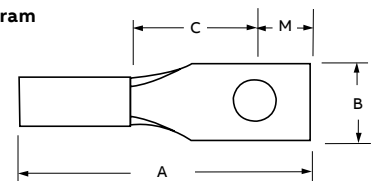

* Not available on tape.

Note: A, B, C486 for use with BU-Ships terminal board types 26TB. A, B, C485 for use with 25TB, 27TB. A, B, C483 for use with 8TB. A, B, C484 for use with 10TB and 11TB. A, B, C481 for use with 6TB, 7TB and 9TB. A, B, C482 for use with 15TB. A, B, C480 for use with 3TB, 5TB, 16TB, 17TB and 18TB.

Note:

22-18 ga. = 1-2 Navy
16-14 ga. = 2½-4 Navy
12-10 ga. = 6-9 Navy

Flag terminals

Non-insulated flags



Non-insulated flags



Cat. no.	Pkg. qty.	Wire range (AWG)	Bolt hole (in.)	Rec. tool	Dimensions (in.)				Stock thick. (in.)		
					A	B	C	M			
AB14-6A	100	22-14	#6	ERG4004	0.55	0.31	0.22	0.39	0.03		
AB51	1,000	22-14	#6		0.55	0.31	0.22	0.39			
AB14-8A	100	22-14	#8		0.55	0.31	0.22	0.39			
AB52	1,000	22-14	#8		0.55	0.31	0.22	0.39			
AB14-10A	100	22-14	#10		0.55	0.31	0.22	0.39			
AB53	1,000	22-14	#10		0.55	0.31	0.22	0.39			
C51	500	12-10	#6		0.66	0.31	0.25	0.48	0.04		
C10-8A	50	12-10	#8		0.66	0.31	0.25	0.48			
C52	500	12-10	#8		0.66	0.31	0.25	0.48			
C10-10A	50	12-10	#10		0.66	0.31	0.25	0.48			
C53	500	12-10	#10		0.66	0.31	0.25	0.48			
D236	200	8	#10		WT129	0.83	0.50	0.25		0.59	0.06
D226	200	8	#10	0.90		0.50	0.29	0.64			
D271	200	8	1/4	0.92		0.50	0.33	0.68			
E226	200	6	#10		0.93	0.50	0.29	0.69	0.06		
E271	200	6	1/4		0.99	0.50	0.33	0.73			
E272	200	6	5/16		1.05	0.50	0.41	0.81			
F226	200	4	#10		1.07	0.56	0.33	0.80			
F271	200	4	1/4		1.10	0.63	0.33	0.80			
F272	200	4	5/16		1.18	0.63	0.41	0.88			
F273	200	4	3/8	1.20	0.63	0.43	0.90				
G671	100	2	1/4		1.20	0.63	0.33	0.89	0.08		
G672	100	2	5/16		1.28	0.63	0.41	0.97			
G673	100	2	3/8		1.32	0.63	0.46	1.02			
H672	50	1/0	5/16		13642M	1.31	0.63	0.41		1.01	0.10
H673	50	1/0	3/8			1.36	0.63	0.46		1.06	
J672	50	2/0	5/16			1.46	0.75	0.41		1.10	
J673	50	2/0	3/8	1.51	0.75	0.46	1.15				
J675	50	2/0	1/2	1.67	0.75	0.55	1.24				
K672	50	3/0	5/16		1.59	0.81	0.41	1.19	0.11		
K673	50	3/0	3/8		1.64	0.81	0.46	1.24			
K675	50	3/0	1/2		1.76	0.81	0.55	1.34			
M673	50	250 kcmil	3/8		1.89	1.0	0.46	1.43	0.13		
M675	50	250 kcmil	1/2		1.99	1.0	0.55	1.52			

Diagram

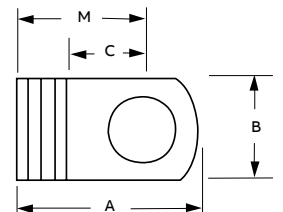

Fork terminals

Nylon-insulated forks & nylon-insulated locking forks

- Fork terminals enable easy installation because the mounting screw does not have to be completely removed.
- Brazed-seam barrel is serrated for high pull-out value. Terminal is high-conductivity electrolytic copper, electro-tin plated. Insulation is color coded.

- Vinyl-insulated fork terminals have extra-long PVC insulation sleeve for protection and stress relief at wire's flex point.
- Suffix "X" indicates an expanded insulation support, meaning a wider wire entry to accommodate heavy wall insulation.



Nylon-insulated forks



Cat. no.	Pkg. qty.	Wire range (AWG)	Max. ins. (in.)	Bolt hole (in.)	Rec. tool	Dimensions (in.)				Stock thick. (in.)
						A	B	C	M	
RA18-6F	100	22-16	0.136	#6	ERG4001	0.83	0.25	0.25	0.71	0.02
RA1103	1,000	22-16	0.136	#6		0.83	0.25	0.25	0.71	0.02
RA18-8F	100	22-16	0.136	#8		0.86	0.31	0.25	0.71	0.02
RA1123	1,000	22-16	0.136	#8		0.86	0.31	0.25	0.71	0.02
RA18-10F	100	22-16	0.136	#10		0.86	0.31	0.25	0.71	0.02
RA1153	1,000	22-16	0.136	#10		0.86	0.31	0.25	0.71	0.02
RA18-14F	100	22-16	0.136	1/4		0.95	0.44	0.31	0.70	0.02
RA1163	1,000	22-16	0.136	1/4		0.95	0.44	0.31	0.70	0.02
RB14-6F	100	18-14	0.162	#6		0.87	0.31	0.25	0.71	0.03
RB1113	1,000	18-14	0.162	#6		0.87	0.31	0.25	0.71	0.03
RB14-8F	100	18-14	0.162	#8		0.87	0.31	0.25	0.71	0.03
RB1123	1,000	18-14	0.162	#8		0.87	0.31	0.25	0.71	0.03
RB14-10F	100	18-14	0.162	#10		0.87	0.38	0.25	0.71	0.03
RB1153	1,000	18-14	0.162	#10		0.87	0.38	0.25	0.71	0.03
RB14-14F	100	18-14	0.162	1/4		0.95	0.44	0.28	0.74	0.03
RB1163	1,000	18-14	0.162	1/4		0.95	0.44	0.28	0.74	0.03
RB1103	1,000	18-14	0.162	#6		0.74	0.28	0.16	0.60	0.03
RB1124	1,000	18-14	0.190	#8		0.95	0.31	0.25	0.79	0.03
RB1154	1,000	18-14	0.190	#10		0.95	0.31	0.25	0.79	0.03
RC10-6F	50	12-10	0.210	#6		0.97	0.31	0.27	0.81	0.04
RC1113	500	12-10	0.210	#6		0.97	0.31	0.27	0.81	0.04
RC10-8F	50	12-10	0.210	#8		1.00	0.37	0.27	0.81	0.04
RC1123	500	12-10	0.210	#8		1.00	0.37	0.27	0.81	0.04
RC10-10F	50	12-10	0.210	#10		1.00	0.37	0.27	0.81	0.04
RC1153	500	12-10	0.210	#10		1.00	0.37	0.27	0.81	0.04
RC10-14F	50	12-10	0.210	1/4		1.12	0.50	0.27	0.86	0.04
RC1163	500	12-10	0.210	1/4		1.12	0.50	0.27	0.86	0.04
RC1124	1,000	12-10	0.250	#8		1.10	0.37	0.27	0.91	0.04
RC1154	1,000	12-10	0.250	#10		1.10	0.37	0.27	0.91	0.04

Diagram

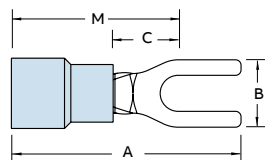

Nylon-insulated locking forks



Cat. no.	Pkg. qty.	Wire range (AWG)	Max. ins. (in.)	Bolt hole (in.)	Rec. tool	Dimensions (in.)				Stock thick. (in.)
						A	B	C	M	
RA18-6FL	100	22-16	0.136	#6	ERG4001	0.86	0.25	0.25	0.71	0.02
RA2213	1,000	22-16	0.136	#6		0.86	0.25	0.25	0.71	0.02
RA18-8FL	100	22-16	0.136	#8		0.86	0.29	0.25	0.71	0.02
RA2243	1,000	22-16	0.136	#8		0.86	0.29	0.25	0.71	0.02
RA18-10FL	100	22-16	0.136	#10		0.86	0.29	0.25	0.71	0.02
RA2253	1,000	22-16	0.136	#10		0.86	0.29	0.25	0.71	0.02
RB14-6FL	100	18-14	0.162	#6		0.87	0.25	0.25	0.71	0.03
RB2213	1,000	18-14	0.162	#6		0.87	0.25	0.25	0.71	0.03
RB2214	1,000	18-14	0.190	#6		0.95	0.25	0.25	0.79	0.03
RB14-8FL	100	18-14	0.162	#8		0.87	0.29	0.25	0.71	0.03
RB2233	1,000	18-14	0.162	#8		0.87	0.29	0.25	0.71	0.03
RB14-10FL	100	18-14	0.162	#10		0.87	0.29	0.25	0.71	0.03
RB2253	1,000	18-14	0.162	#10		0.87	0.29	0.25	0.71	0.03
RB2254	1,000	18-14	0.190	#10		0.95	0.29	0.25	0.71	0.03
RC10-6FL	50	12-10	0.210	#6		0.97	0.31	0.27	0.81	0.04
RC2203	500	12-10	0.210	#6		0.97	0.31	0.27	0.81	0.04
RC2204	1,000	12-10	0.250	#6		1.07	0.31	0.27	0.91	0.04
RC10-8FL	50	12-10	0.210	#8		1.00	0.37	0.27	0.81	0.04
RC2213	500	12-10	0.210	#8		1.00	0.37	0.27	0.81	0.04
RC10-10FL	50	12-10	0.210	#10		1.00	0.37	0.27	0.81	0.04
RC2223	500	12-10	0.210	#10		1.00	0.37	0.27	0.81	0.04
RC2224	1,000	12-10	0.250	#10		1.10	0.37	0.27	0.91	0.04
RC10-14FL	50	12-10	0.210	1/4		1.12	0.50	0.32	0.86	0.04
RC2233	500	12-10	0.210	1/4		1.12	0.50	0.32	0.86	0.04

Diagram

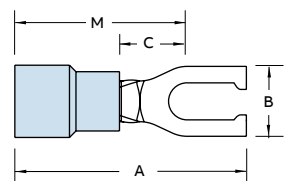

Fork terminals

Nylon-insulated forks & vinyl-insulated forks

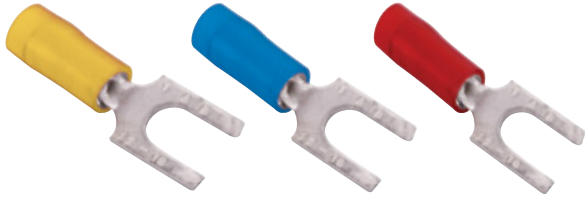

Nylon-insulated forks – Flanged tongue



Cat. no.	Pkg. qty.	Wire range (AWG)	Max. ins. (in.)	Bolt hole (in.)	Rec. tool	Dimensions (in.)				Stock thick. (in.)
						A	B	C	M	
RA18-6FS	100	22-16	0.136	#6	ERG4001	0.75	0.28	0.16	0.62	0.02
RA1203	1,000	22-16	0.136	#6		0.75	0.28	0.16	0.62	0.02
RA18-8FS	100	22-16	0.136	#8		0.89	0.31	0.23	0.65	0.02
RA1223	1,000	22-16	0.136	#8		0.89	0.31	0.23	0.65	0.02
RA18-10FS	100	22-16	0.136	#10		0.93	0.38	0.26	0.68	0.02
RA1253	1,000	22-16	0.136	#10		0.93	0.38	0.26	0.68	0.02
RB14-6FS	100	18-14	0.162	#6		0.74	0.28	0.16	0.60	0.03
RB1203	1,000	18-14	0.162	#6		0.74	0.28	0.16	0.60	0.03
RB14-8FS	100	18-14	0.162	#8		0.89	0.31	0.23	0.66	0.03
RB1223	1,000	18-14	0.162	#8		0.89	0.31	0.23	0.66	0.03
RB14-10FS	100	18-14	0.162	#10		0.94	0.38	0.27	0.69	0.03
RB1253	1,000	18-14	0.162	#10		0.94	0.38	0.27	0.69	0.03
RB1204	1,000	18-14	0.190	#6		0.79	0.28	0.16	0.67	0.03
RB1224	1,000	18-14	0.190	#8		0.94	0.31	0.23	0.71	0.03
RC10-8FS	50	12-10	0.210	#8		0.97	0.34	0.23	0.73	0.04
RC1223	500	12-10	0.210	#8		0.97	0.34	0.23	0.73	0.04
RC10-10FS	50	12-10	0.210	#10		1.00	0.38	0.26	0.74	0.04
RC1253	500	12-10	0.210	#10		1.00	0.38	0.26	0.74	0.04
RC1224	1,000	12-10	0.250	#8		1.08	0.34	0.23	0.80	0.04
RC1254	1,000	12-10	0.250	#10		1.12	0.38	0.26	0.86	0.04

Diagram

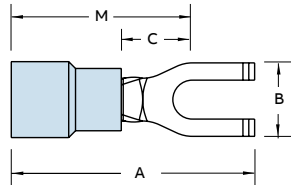

Vinyl-insulated forks



Cat. no.	Pkg. qty.	Wire range (AWG)	Max. ins. (in.)	Bolt hole (in.)	Rec. tool	Dimensions (in.)				Stock thick. (in.)
						A	B	C	M	
18RA-6F	100	22-16	0.150	#6	ERG4001	0.94	0.25	0.27	0.81	0.02
RA1167	1,000	22-16	0.150	#6		0.94	0.25	0.27	0.81	0.02
18RA-8F	100	22-16	0.150	#8		0.97	0.31	0.27	0.81	0.02
RA1147	1,000	22-16	0.150	#8		0.97	0.31	0.27	0.81	0.02
18RA-10F	100	22-16	0.150	#10		0.97	0.31	0.27	0.81	0.02
RA1157	1,000	22-16	0.150	#10		0.97	0.31	0.27	0.81	0.02
14RB-6F	100	18-14	0.170	#6		0.97	0.31	0.27	0.81	0.03
RB647	1,000	18-14	0.170	#6		0.97	0.31	0.27	0.81	0.03
14RB-6FS	100	18-14	0.170	#6		0.89	0.30	0.25	0.75	0.03
14RB-8F	100	18-14	0.170	#8		0.97	0.31	0.27	0.81	0.03
RB657	1,000	18-14	0.170	#8		0.97	0.31	0.27	0.81	0.03
14RB-10F	100	18-14	0.170	#10		0.97	0.31	0.27	0.81	0.03
RB1157	1,000	18-14	0.170	#10		0.97	0.31	0.27	0.81	0.03
14RB-14F	100	18-14	0.170	¼		1.11	0.44	0.38	0.89	0.03
RB1717	1,000	18-14	0.170	¼		1.11	0.44	0.38	0.89	0.03
10RC-6F	50	12-10	0.210	#6		1.09	0.31	0.27	0.90	0.04
RC1337	500	12-10	0.210	#6		1.09	0.31	0.27	0.90	0.04
10RC-8F	50	12-10	0.210	#8		1.09	0.38	0.27	0.90	0.04
RC1147	500	12-10	0.210	#8		1.09	0.38	0.27	0.90	0.04
10RC-10F	50	12-10	0.210	#10		1.09	0.38	0.27	0.90	0.04
RC1157	500	12-10	0.210	#10		1.09	0.38	0.27	0.90	0.04
10RC-14F	50	12-10	0.210	¼		1.15	0.50	0.37	0.90	0.04
RC1167	500	12-10	0.210	¼		1.15	0.50	0.37	0.90	0.04

Diagram

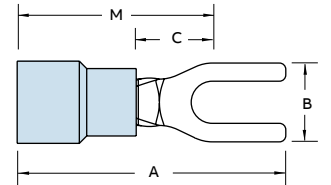

For multiple wire combinations per UL® file E9609, see page 14.

Fork terminals

Vinyl-insulation forks & vinyl-insulated locking forks



Vinyl-insulation forks – Expanded insulation



Cat. no.	Pkg. qty.	Wire range (AWG)	Max. ins. (in.)	Bolt hole (in.)	Rec. tool	Dimensions (in.)				Stock thick. (in.)
						A	B	C	M	
18RA-6FX	100	22-16	0.170	#6	ERG4001	0.94	0.25	0.27	0.81	0.02
RA1167-170	1,000	22-16	0.170	#6		0.94	0.25	0.27	0.81	
18RA-8FX	100	22-16	0.170	#8		0.97	0.31	0.27	0.81	
RA1147-170	1,000	22-16	0.170	#8		0.97	0.31	0.27	0.81	
18RA-10FX	100	22-16	0.170	#10		0.97	0.31	0.27	0.81	
RA1157-170	1,000	22-16	0.170	#10		0.97	0.31	0.27	0.81	
14RB-6FX	100	18-14	0.200	#6		0.97	0.31	0.27	0.81	0.03
RB647-200	1,000	18-14	0.200	#6		0.97	0.31	0.27	0.81	
14RB-8FX	100	18-14	0.200	#8		0.97	0.31	0.27	0.81	
RB657-200	1,000	18-14	0.200	#8		0.97	0.31	0.27	0.81	
14RB-10FX	100	18-14	0.200	#10		0.97	0.31	0.27	0.81	
RB1157-200	1,000	18-14	0.200	#10		0.97	0.31	0.27	0.81	
10RC-8FX	50	12-10	0.250	#8		1.11	0.38	0.27	0.90	0.04
RC1147-250	500	12-10	0.250	#8		1.11	0.38	0.27	0.90	
10RC-10FX	50	12-10	0.250	#10		1.11	0.38	0.27	0.90	
RC1157-250	500	12-10	0.250	#10		1.11	0.38	0.27	0.90	
10RC-14FX	50	12-10	0.250	¼		1.17	0.50	0.37	0.90	

Diagram

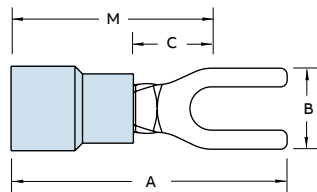

Vinyl-insulated locking forks



Cat. no.	Pkg. qty.	Wire range (AWG)	Max. ins. (in.)	Bolt hole (in.)	Rec. tool	Dimensions (in.)				Stock thick. (in.)
						A	B	C	M	
18RA-6FL	100	22-16	0.150	#6	ERG4001	0.97	0.25	0.25	0.81	0.02
RA2217	1,000	22-16	0.150	#6		0.97	0.25	0.25	0.81	
RA2227	1,000	22-16	0.155	#6		0.97	0.29	0.25	0.81	
18RA-8FL	100	22-16	0.150	#8		0.97	0.29	0.25	0.81	
RA2247	1,000	22-16	0.150	#8		0.97	0.29	0.25	0.81	
18RA-10FL	100	22-16	0.150	#10		0.97	0.29	0.25	0.81	
RA2257	1,000	22-16	0.150	#10		0.97	0.29	0.25	0.81	
14RB-6FL	100	18-14	0.170	#6		0.97	0.25	0.27	0.81	0.03
RB2207	1,000	18-14	0.170	#6		0.97	0.25	0.27	0.81	
RB2217	1,000	18-14	0.170	#6		0.97	0.29	0.27	0.81	
14RB-8FL	100	18-14	0.170	#8		0.97	0.29	0.27	0.81	
RB2237	1,000	18-14	0.170	#8		0.97	0.29	0.27	0.81	
14RB-10FL	100	18-14	0.170	#10		0.97	0.29	0.27	0.81	
RB2257	1,000	18-14	0.170	#10		0.97	0.29	0.27	0.81	
10RC-6FL	50	12-10	0.220	#6		1.09	0.31	0.27	0.90	0.04
RC2207	500	12-10	0.220	#6		1.09	0.31	0.27	0.90	
10RC-8FL	50	12-10	0.220	#8		1.09	0.37	0.27	0.90	
RC2217	500	12-10	0.220	#8		1.09	0.37	0.27	0.90	
10RC-10FL	50	12-10	0.220	#10		1.09	0.37	0.27	0.90	
RC2227	500	12-10	0.220	#10		1.09	0.37	0.27	0.90	
10RC-14FL	50	12-10	0.220	¼		1.09	0.49	0.27	0.90	
RC2237	500	12-10	0.220	¼		1.09	0.49	0.27	0.90	

Diagram

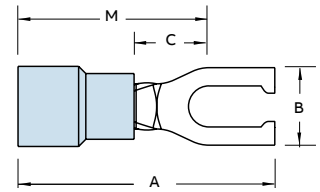

For multiple wire combinations per UL® file E9609, see page 14.

For multiple wire combinations per UL file E9609, see page 14.

Fork terminals

Vinyl-insulated locking forks & non-insulated forks



Vinyl-insulated locking forks – Expanded insulation



Cat. no.	Wire range (AWG)	Max. ins. (in.)	Bolt hole (in.)	Rec. tool	Dimensions (in.)				Stock thick. (in.)
					A	B	C	M	
18RA-6FLX	100 22-16	0.170	#6	ERG4001	0.97	0.25	0.25	0.81	0.02
RA2217-170	1,000 22-16	0.170	#6		0.97	0.25	0.25	0.81	0.02
18RA-8FLX	100 22-16	0.170	#8		0.97	0.29	0.25	0.81	0.02
18RA-10FLX	100 22-16	0.170	#10		0.97	0.29	0.25	0.81	0.02
RA2257-170	1,000 22-16	0.170	#10		0.97	0.29	0.25	0.81	0.02
14RB-6FLX	100 18-14	0.200	#6		0.97	0.31	0.27	0.81	0.03
RB2207-200	1,000 18-14	0.200	#6		0.97	0.31	0.27	0.81	0.03
RB2217-200	1,000 18-14	0.200	#6		0.97	0.29	0.27	0.81	0.03
14RB-8FLX	100 18-14	0.200	#8		0.97	0.31	0.27	0.81	0.03
RB2237-200	1,000 18-14	0.200	#8		0.97	0.31	0.27	0.81	0.03
14RB-10FLX	100 18-14	0.200	#10		0.97	0.31	0.27	0.81	0.03
RB2257-200	1,000 18-14	0.200	#10		0.97	0.31	0.27	0.81	0.03
10RC-6FLX	50 12-10	0.250	#6		1.07	0.31	0.27	0.91	0.04
RC2207-250	500 12-10	0.250	#6		1.07	0.31	0.27	0.91	0.04
10RC-8FLX	50 12-10	0.250	#8		1.10	0.37	0.27	0.91	0.04
10RC-10FLX	50 12-10	0.250	#10		1.10	0.37	0.27	0.91	0.04
RC2227-250	500 12-10	0.250	#10		1.10	0.37	0.27	0.91	0.04
10RC-14FLX	50 12-10	0.250	¼		1.22	0.50	0.32	0.96	0.04

Diagram

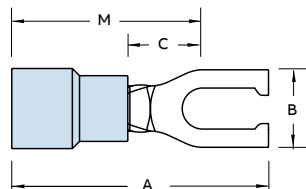

Non-insulated forks



Cat. no.	Pkg. qty.	Wire range (AWG)	Bolt hole (in.)	Rec. tool	Dimensions (in.)				Stock thick. (in.)
					A	B	C	M	
A18-6F	100	22-16	#6	ERG4002	0.72	0.25	0.27	0.59	0.02
A116	1,000	22-16	#6		0.72	0.25	0.27	0.59	0.02
A18-8F	100	22-16	#8		0.75	0.31	0.27	0.59	0.02
A114	1,000	22-16	#8		0.75	0.31	0.27	0.59	0.02
A18-10F	100	22-16	#10		0.75	0.31	0.27	0.59	0.02
A115-TB	1,000	22-16	#10		0.75	0.31	0.27	0.59	0.02
B14-6F	100	18-14	#6	ERG4002	0.75	0.31	0.27	0.59	0.03
B64	1,000	18-14	#6	ERG4005	0.75	0.31	0.27	0.59	0.03
B19	1,000	18-14	#6		0.66	0.25	0.13	0.50	0.03
B14-8F	100	18-14	#8		0.75	0.31	0.27	0.59	0.03
B65-TB	1,000	18-14	#8		0.75	0.31	0.27	0.59	0.03
B14-10F	100	18-14	#10		0.75	0.31	0.27	0.59	0.03
B115	1,000	18-14	#10		0.75	0.31	0.27	0.59	0.03
B14-14F	100	18-14	¼		0.90	0.44	0.38	0.68	0.03
C10-6F	50	12-10	#6		0.77	0.31	0.27	0.63	0.04
C133	500	12-10	#6		0.77	0.31	0.27	0.63	0.04
C10-8F	50	12-10	#8		0.82	0.38	0.27	0.63	0.04
C114	500	12-10	#8		0.82	0.38	0.27	0.63	0.04
C10-10F	50	12-10	#10		0.82	0.38	0.27	0.63	0.04
C115	500	12-10	#10		0.82	0.38	0.27	0.63	0.04
C10-14F	50	12-10	¼		0.98	0.50	0.37	0.73	0.04
C116-TB	500	12-10	¼		0.98	0.50	0.37	0.73	0.04

Diagram

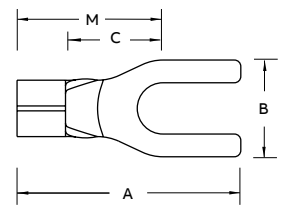

For multiple wire combinations per UL® File E9609, see page 14.

Fork terminals and Pin terminals

Non-insulated locking fork terminals & pin terminals



Non-insulated locking fork terminals



Cat. no.	Pkg. qty.	Wire range (AWG)	Bolt hole (in.)	Rec. tool	Dimensions (in.)				Stock thick. (in.)
					A	B	C	M	
A18-6FL	100	22-16	#6	ERG4002	0.75	0.25	0.27	0.59	0.02
A221	1,000	22-16	#6		0.75	0.25	0.27	0.59	
A18-8FL	100	22-16	#8		0.75	0.29	0.27	0.59	
A224	1,000	22-16	#8		0.75	0.29	0.27	0.59	
A18-10FL	100	22-16	#10		0.75	0.29	0.27	0.59	
A225	1,000	22-16	#10		0.75	0.29	0.27	0.59	0.03
B14-6FL	100	18-14	#6	ERG4002	0.75	0.25	0.27	0.59	
B220	1,000	18-14	#6	ERG4005	0.75	0.25	0.27	0.59	
B14-8FL	100	18-14	#8		0.75	0.29	0.27	0.59	
B223	1,000	18-14	#8		0.75	0.29	0.27	0.59	
B14-10FL	100	18-14	#10		0.75	0.29	0.27	0.59	0.04
B225	1,000	18-14	#10		0.75	0.29	0.27	0.59	
C10-6FL	50	12-10	#6		0.85	0.31	0.27	0.66	
C220-TB	500	12-10	#6		0.85	0.31	0.27	0.66	
C10-8FL	50	12-10	#8		0.85	0.37	0.27	0.66	
C221	500	12-10	#8		0.85	0.37	0.27	0.66	0.04
C10-10FL	50	12-10	#10		0.85	0.37	0.27	0.66	
C222	500	12-10	#10		0.85	0.37	0.27	0.66	
C10-14FL	50	12-10	¼		0.85	0.49	0.27	0.66	

Diagram

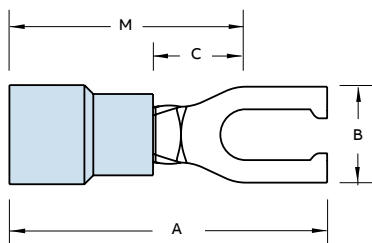

Pin terminals



Cat. no.	Pkg. qty.	Wire range (AWG)	Dimensions (in.)		Rec. tools	Stock thick. (in.)
			D (Dia.)	L		
Non-insulated						
A47PT	1,000	22-18	0.075	0.63	ERG4002	0.02
B47PT	1,000	16-14	0.075	0.63		0.03
C55PT	500	12-10	0.106	0.76		0.04
Vinyl						
18RA-47PT	100	22-18	0.075	0.85	ERG4001	0.02
RA47PT	1,000	22-18	0.075	0.85		0.03
14RB-47PT	100	16-14	0.075	0.87		0.04
RB47PT	1,000	16-14	0.075	0.87		0.04
10RC-55PT	50	12-10	0.106	1.04		0.04
RC55PT	500	12-10	0.106	1.04		0.04
Nylon						
RA18-47PT	100	22-18	0.075	0.85	ERG4001	0.02
RA147PT	1,000	22-18	0.075	0.85		0.03
RB14-47PT	100	16-14	0.075	0.87		0.04
RB147PT	1,000	16-14	0.075	0.87		0.04
RC10-55PT	50	12-10	0.106	1.04		0.04
RC155PT	500	12-10	0.106	1.04		0.04

Diagrams

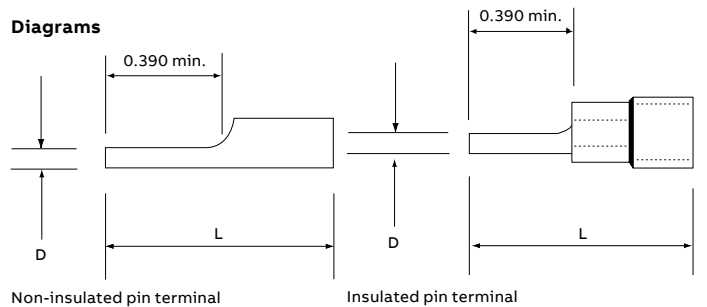

Splice connectors

Vinyl-insulated butt splices & nylon-insulated aircraft splices

Butt splices

- Wires are butted together and crimped at each end of the splice
- Available either non-insulated or insulated with nylon or PVC
- Nylon-insulated splices meet or exceed the requirements of MIL-T-7928
- Color-coded according to wire size

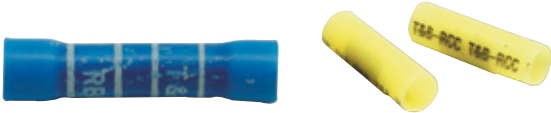

Vinyl-insulated butt splices – Expanded insulation



Cat. no.	Pkg. qty.	Wire range (AWG)	Max. ins. (in.)	Rec. tool	Dimensions (in.)	
					A	B
2RA18X	100	22–18	0.170	ERG4001	1.13	0.25
RAA217-170	1,000	22–18	0.170		1.13	0.25
RAA217	1,000	22–18	0.150		1.13	0.23
2RB14X	100	16–14	0.200		1.13	0.26
RBB217-200	1,000	16–14	0.200		1.13	0.26
RBB217	1,000	16–14	0.170		1.13	0.24
2RC10X	50	12–10	0.250		1.31	0.31
RCC217-250	500	12–10	0.250		1.31	0.31
RCC217	1,000	12–10	0.210		1.31	0.28

Diagram

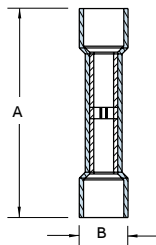

Parallel splices

- Wires are laid side by side in the connector, and the connection is made in one crimp
- Offer advantages in simplicity of installation and small size
- One crimp completes the splice



Nylon-insulated aircraft splices

Cat. no.	Pkg. qty.	Wire range (AWG)	Rec. tool	Dimensions (in.)	
				A	B
2RZZ	50	26–22	ERG4006	1.22	0.15
RZZ23	500	26–22			
2RAA	50	22–18	ERG4001	1.52	0.25
RAA23	500	22–18			
2RBB	50	16–14		1.52	0.28
RBB23	500	16–14			
2RCC	25	12–10		1.54	0.35
RCC23	250	12–10			

Diagram

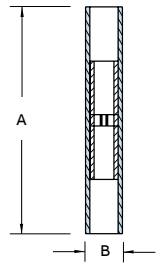

Note: RCC217 is not expanded.

Splice connectors

Nylon-insulated butt splices & Tefzel® insulated butt splices

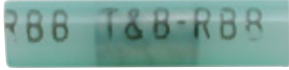

Nylon-insulated butt splices



Cat. no.	Pkg. qty.	Max. ins. dia. (in.)	Wire range (AWG)	Rec. tool	Dimensions (in.)	
					A	B
2RA18	100	0.115	22-18	ERG4001	1.19	0.18
RAA21	1,000	0.115	22-18			
2RB14	100	0.148	16-14		1.19	0.21
RBB21	1,000	0.148	16-14			
2RC10	50	0.210	12-10		1.26	0.28
RCC21	500	0.210	12-10			
2RD8	25	0.340	8	ERG4007	1.69	0.36
RDD27	200	0.340	8		TBM6S	
2RE6	20	0.420	6	TBM6S	1.85	0.45
REE28	200	0.420	6			
2RF4	15	0.510	4	TBM6S	1.85	0.52

Diagram

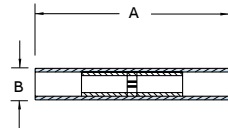

Tefzel insulated butt splices



Cat. no.	Pkg. qty.	Wire range (AWG)	Max. ins. dia. (in.)	Rec. tool	Dimensions (in.)	
					A	B
RAAT21	1,000	22-18	1.22	WT145C	1.22	0.115
RBBT21	1,000	16-14	1.22		1.22	0.148
RCCT21	1,000	12-10	1.22		1.22	0.210

Diagram

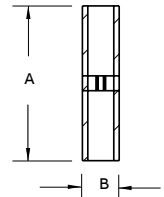

Tefzel is a registered trademark of DuPont.

Splice connectors

Non-insulated butt splices & nylon-insulated parallel splices



Non-insulated butt splices



Cat. no.	Pkg. qty.	Wire range (AWG)	Rec. tool	Dimensions (in.)	
				A	B
2A-18	100	22-18	ERG4002	0.62	0.12
AA2	1,000	22-18			
2B-14	100	16-14	ERG4002	0.62	0.16
BB2	1,000	16-14	ERG4005		
2C-10	50	12-10		0.72	0.22
CC2	500	12-10			
2D-8	25	9-8-7	ERG4005	1.03	0.28
DD102	200	9-8-7	TBM6S		
2E-6	20	6-5		1.12	0.37
EE2	200	6-5			
2F-4	15	4-3	TBM6S	1.25	0.44
FF2	200	4-3			
2G21	5	2-1		1.72	0.55
GG2	25	2-1			

Diagram

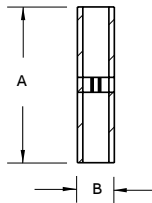

Nylon-insulated parallel splices



Cat. no.	Pkg. qty.	Wire range (AWG)	Rec. tool	Dimensions (in.)	
				A	B
2A20	100	22-20	ERG4001	0.84	0.20
RAA24	1,000	22-20			
2B-16	100	18-16		0.84	0.23
RBB25	1,000	18-16			
2C-12	50	14-12		0.90	0.28
RCC26	500	14-12			

Diagram

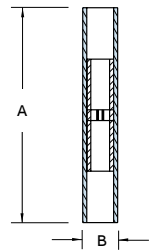

Splice connectors

Sta-kon® parallel splices



Sta-kon parallel splices



Cat. no.	Wire range (AWG or kcmil)	Cir. mil range	Rec. tool	Dimensions (in.)			Pkg. qty.
				Length (A)	O.D. (B)	I.D. (C)	
A18-PS-M	22-16	509-3,260	ERG4002	0.314	0.129	0.086	1,000
B14-PS-M	16-14	2,050-5,180	ERG4002	0.315	0.155	0.113	1,000
C10-PS-D	12-10	5,180-13,100	ERG4005	0.380	0.220	0.170	500
D8-PS-D	8	13,100-20,800	ERG4005	0.375	0.260	0.180	500
E6-PS-D	6	20,800-33,100	WT115A	0.500	0.365	0.266	500
F4-PS-W	4	33,100-52,600	WT115A	0.531	0.410	0.302	250
G2-PS-W	2	52,600-83,700		0.640	0.521	0.396	250
H1/0-PS-C	1/0	83,700-119,500	TBM8-750M-1	0.750	0.571	0.446	100
J2/0-PS-C	2/0	119,500-150,500		0.750	0.632	0.507	100
K3/0-PS-L	3/0	150,500-190,000		0.750	0.701	0.564	50
L4/0-PS-L	4/0	190,000-231,100		0.770	0.766	0.629	50
M250-PS-Q	250	231,100-300,000		1.063	0.926	0.749	25
N300-PS-X	300	300,000-380,000		1.125	1.100	0.882	10
P400-PS-X	400	380,000-478,000		1.250	1.200	0.956	10
R500-PS-V	500	478,000-600,000		1.438	1.330	1.060	5

Diagram

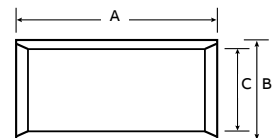

The total combined cross sectional area of all wires must be within the CMA range.
Rated at 150 °C.

Wire joints

Crimp-on wire joints, one-piece nylon self-insulated



Crimp-on wire joints, one-piece nylon self-insulated



Cat. no.	Pkg. qty.	Wire range (AWG)		Rec. tool	Dimensions (in.)	
		min.	max.		A	B
RB44	100	2#18	2#16	WT2000	0.31	0.78
RB4-TB	1,000	2#18	2#16		0.31	0.78
RC55	50	4#18	2#12	WT2130A	0.43	0.95
RC6	500	4#18	2#12		0.43	3
RP12	100	3#14	4#12		0.53	1.00
RP7	1,000	3#14	4#12		0.53	1.00

Diagram

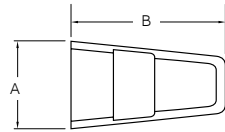

Cat. no.	Allowable wire combinations (AWG)						
	#22	#20	#18	#16	#14	#12	#10
RB4-TB/ RB44	-	-	2-3	-	-	-	-
	-	-	1-2	2	-	-	-
	3	-	-	-	-	-	-
	-	3	-	-	-	-	-
	3	-	1	-	-	-	-
	2	3	-	-	-	-	-
	1-2	-	2	-	-	-	-
	2	-	-	1	-	-	-
	-	3	1	-	-	-	-
	1	2	-	-	-	-	-
	-	2	-	1	-	-	-
	-	1	2	-	-	-	-

Cat. no.	Allowable wire combinations (AWG)						
	#22	#20	#18	#16	#14	#12	#10
RC6/ RC55	-	-	1-4	-	-	1	-
	-	-	-	1-3	-	1	-
	-	-	-	-	1-2	1	-
	-	-	-	-	-	2	-
	-	-	3-5	-	1	-	-
	-	-	-	2-4	1	-	-
	-	-	-	-	3	-	-
	-	-	1-4	-	2	-	-
	-	-	-	1-3	2	-	-
	-	-	1-3	-	3	-	-
	-	-	-	1	3	-	-
	-	-	-	2-5	-	-	-
	-	-	4-6	-	-	-	-

Cat. no.	Allowable wire combinations (AWG)						
	#22	#20	#18	#16	#14	#12	#10
RP7/ RP12	-	-	-	-	-	-	2
	-	-	-	-	-	1	1
	-	-	-	-	1	-	1
	-	-	-	-	-	2-4	-
	-	-	-	-	2-4	1	-
	-	-	-	-	1-3	2	-
	-	-	-	-	1	3	-
	-	-	-	-	3-6	-	-
	-	-	-	-	1	2-3	-
	-	-	-	-	2	1-2	-
	-	-	-	-	3	1-2	-
	-	-	-	-	4	1	-
	-	-	-	-	-	-	-

Wire joints

PT series crimp-on wire joints

- 01 Two-piece nylon insulator
- 02 One-piece non-insulated



PT series crimp-on wire joints



Cat. no.	Pkg. qty.	Wire range (AWG)		Rec. tool	Dimensions (in.)	
		min.	max.		A	B
PT66M	100	2#18	3#12 combination	WT161M	0.50	0.93
PT6M	100	—	Insulator only		0.50	0.93
PT60M	100	2#14	3#12 connector only		0.31	0.37
PT70	200	2#14	3#12		0.29	0.34
PT70M	200	3#18	4#12		0.31	0.37
PT80	50	2#16	4#10		0.35	0.62

Diagrams

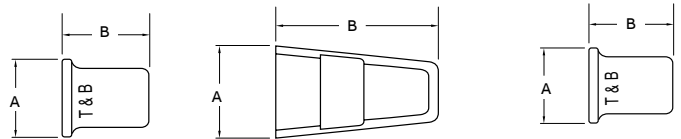

90 °C rated.

- 01 Twist wires, insert through serrated barrel of wire joint (PT60M, PT70, PT70M, PT80).

Installation procedure for "PT" connectors

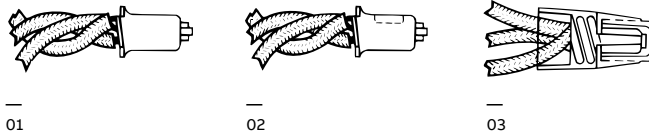

- 02 Crimp and trim off excess wire with WT161M hand tool.

- 03 Screw PT6 insulator firmly onto PT160M barrel.

Wire joints

High-temperature wire joints & wire joints UL® listed combinations



- Rated for temperatures up to 150 °C (302 °F), 600 V maximum
- Molded, one-piece nylon construction for electrical insulation, UL94-V2
- Brazed copper sleeve prevents separation of connection during crimping
- Internal serrations enable cold flow for increased conductivity and pull-out strength

High-temperature wire joints



Cat. no.	Pkg. qty.	Wire range (AWG)		Rec. tool	Dimensions (in.)	
		min.	max.		A	B
RB4-HT	1,000	2#18	2#16	WT2000	0.36	0.82
RB44-HT	100	2#18	2#16	WT2000	0.36	0.82
RC6-HT	500	3#16	3#14	ERG4001, WT2130A	0.48	0.95
RC551-HT	100	3#16	3#14	ERG4001, WT2130A	0.48	0.95
RP7-HT	500	3#14	3#12	ERG4007, WT2130A	0.53	1.00
RP12-HT	100	3#14	3#12	ERG4007, WT2130A	0.53	1.00

Wire joints UL listed combinations

Cat. no.	Solid or stranded AWG	Cat. no.	Solid or stranded AWG	
RB4, RB44, RB4-10M	(2) or (3) #18	RP7, RP-12	(2) to (4) #12	
	(2) #16		(3) to (6) #14	
	(1) #16 and (1) or (2) #18		(3) #12 and (1) #14	
	(3) #22		(2) #12 and (1) #14	
	(3) #20		(2) #12 and (2) #14	
	(3) #22 and (1) #18		(2) #12 and (3) #14	
	(2) #22 and (3) #20		(1) #12 and (2) #14	
	(1) or (2) #22 and (2) #18		(1) #12 and (3) #14	
	(2) #22 and (1) #16		(1) #12 and (4) #14	
	(3) #20 and (1) #18		(2) #10	
	(2) #20 and (1) #22		(1) #10 and (1) #12	
	(2) #20 and (1) #16		(1) #10 and (1) #14	
	(1) #20 and (2) #18		(1) #8 Str. and (1) #16	
	RC6, RC6-5M, RC55		(1) #14 with (2), (3) or (4) #16	(1) #10 and (1) #16
			(1) #14 with (3), (4) or (5) #18	(1) #12 and (1) #16
			(2) #14 with (1), (2), (3) or (4) #18	
(2) #14 with (1), (2) or (3) #16				
(3) #14				
(4) to (7) #18				
(3) #14 with (1) or (2) #18				
(3) #14 with (1) #16				
(1) #12 with (1), (2), (3) or (4) #18				
(1) #12 with (1), (2) or (3) #16				
(1) #12 with (1) or (2) #14				
(5) #16				

Heat-shrinkable terminals, splices, disconnects

Heat-shrinkable ring terminals & heat-shrinkable locking fork terminals



Heat-shrinkable ring terminals



Cat. no.	Pkg. qty.	Wire range (AWG)	Max. ins. (in.)	Bolt hole (in.)	Rec. tool	Dimensions (in.)				Stock thick. (in.)
						A	B	C	M	
RAS18-6X	100	22-18	0.170	#6	ERG4255	1.23	0.25	0.27	1.10	0.03
RAS18-8X	100	22-18	0.170	#8		1.26	0.31	0.27	1.10	0.03
RAS18-10X	100	22-18	0.170	#10		1.26	0.31	0.27	1.10	0.03
RBS14-6X	100	16-14	0.200	#6		1.23	0.25	0.27	1.10	0.03
RBS14-8X	100	16-14	0.200	#8		1.23	0.25	0.27	1.10	0.03
RBS14-10X	100	16-14	0.200	#10		1.26	0.31	0.27	1.10	0.03
RCS10-6X	50	12-10	0.250	#6		1.34	0.31	0.27	1.15	0.04
RCS10-8X	50	12-10	0.250	#8		1.34	0.37	0.27	1.15	0.04
RCS10-10X	50	12-10	0.250	#10		1.34	0.37	0.27	1.15	0.04
RCS10-14X	50	12-10	0.250	¼		1.34	0.49	0.32	1.15	0.04

Diagram

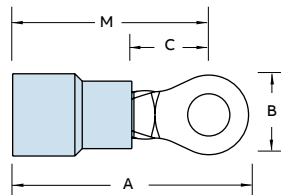

Heat-shrinkable locking fork terminals



Cat. no.	Pkg. qty.	Wire range (AWG)	Max. ins. (in.)	Bolt hole (in.)	Rec. tool	Dimensions (in.)				Stock thick. (in.)
						A	B	C	M	
RAS18-6FLX	100	22-18	0.170	#6	ERG4255	1.350	0.25	-	-	0.03
RAS18-8FLX	100	22-18	0.170	#8		1.350	0.29	-	-	0.03
RAS18-10FLX	100	22-18	0.170	#10		1.350	0.29	-	-	0.03
RBS14-6FLX	100	16-14	0.200	#6		1.350	0.25	-	-	0.03
RBS14-8FLX	100	16-14	0.200	#8		1.350	0.29	-	-	0.03
RBS14-10FLX	100	16-14	0.200	#10		1.350	0.29	-	-	0.03
RCS10-6FLX	50	12-10	0.250	#6		1.350	0.31	-	-	0.04
RCS10-8FLX	50	12-10	0.250	#8		1.350	0.37	-	-	0.04
RCS10-10FLX	50	12-10	0.250	#10		1.350	0.37	-	-	0.04
RCS10-14FLX	50	12-10	0.250	¼		1.350	0.49	-	-	0.04

Diagram

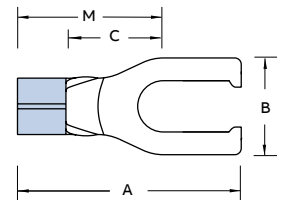

Heat-shrinkable terminals, splices, disconnects



Heat-shrinkable fully insulated female disconnects



Cat. no.	Pkg. qty.	Wire		Tab size (in.)	Rec. tool	Dimensions (in.)	
		range (AWG)	Max. ins. (in.)			A	
RAS18-250AX	25	22-18	0.170	0.250 x 0.032	ERG4255	1.82	
RBS14-250AX	25	16-14	0.200	0.250 x 0.032		1.77	
RCS10-250AX	25	12-10	0.250	0.250 x 0.032		1.80	

Diagram

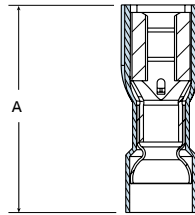

Heat-shrinkable fully insulated male tabs



Cat. no.	Pkg. qty.	Wire		Tab size (in.)	Rec. tool	Dimensions (in.)	
		range (AWG)	Max. ins. (in.)			A	
18RAS-251TX	25	22-18	0.170	0.250 x 0.032	ERG4255	1.80	
14RBS-251TX	25	16-14	0.200	0.250 x 0.032		1.75	
10RCS-251TX	25	12-10	0.250	0.250 x 0.032		1.80	

Diagram

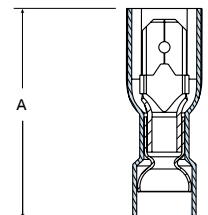

Heat-shrinkable butt splices



Cat. no.	Pkg. qty.	Wire		Rec. tool	Dimensions (in.)	
		range (AWG)	Max. ins. (in.)		A	B
2RAS18X	50	22-18	0.170	ERG4255	1.50	.25
RAAS22X	500	22-18	0.170		1.50	.26
2RBS14X	50	16-14	0.200		1.50	.26
RBBS22X	500	16-14	0.200		1.60	.31
2RCS10X	25	12-10	0.250		1.60	.31
RCCS22X	250	12-10	0.250		1.60	.31

Diagram



Everything you need to make fully sealed connections in one handy kit.

- Tools: (1) butane torch; (1) wire stripper; (1) ratchet crimp tool
- Butt splices: (20) #22-#18 AWG; (20) #16-#14 AWG; (15) #12-#10 AWG
- Ring terminals: (20) #16-#14 AWG #10 stud; (2) #16-#14 AWG #8 stud; (15) #12-#10 AWG ¼" stud

Heat-shrink terminal kit with tools

Cat. no.	Description	Std. pkg. qty.
STAPOUCH-HS	Heat-shrink terminal kit with tools	1

Disconnects and male tabs

Disconnects



- Internal barrel serrations and long barrel provide for maximum tensile strength
- Complete line of installing tools, engineered to match tool with terminal
- Funnel-entry insulators enable easier inserting of wire into barrel
- Color coded for easy installation

250 Series – Female disconnects



- Female disconnect terminals and matching male tabs accommodate a range of #22–#10 AWG, and are available in non-insulated, partially insulated and fully insulated styles, in both nylon and vinyl
- Unique construction of the female disconnect offers long-term dependability
- Brazed-seam serrated barrel provides maximum tensile strength

187 Series – Female disconnects

- Quick, reliable method of connection to terminal blocks and boards without the use of tools
- Female disconnect terminals and matching male tabs accommodate a range of #22–#10 AWG, and are available in non-insulated, partially insulated and fully insulated styles, in both nylon and vinyl
- Unique construction of the female disconnect offers long-term dependability

250 Series – Female disconnects



	Cat. no.	Pkg. qty.	Wire range (AWG)	Max. ins. (in.)	Tab size (in.)	Fig.	Rec. tool	Dimensions (in.)	
								A	B
Nylon self-insulated 	RA18-250F	100	22–18	0.136	0.250 x 0.032	1	ERG4001	0.91	0.29
	RA250	1,000	22–18	0.136	0.250 x 0.032	1		0.91	0.29
	RB14-250F	100	16–14	0.162	0.250 x 0.032	1		1.04	0.29
	RB250	1,000	16–14	0.162	0.250 x 0.032	1		0.96	0.29
	RC10-250F	50	12–10	0.215	0.250 x 0.032	1		0.96	0.29
	RC250	500	12–10	0.215	0.250 x 0.032	1		1.03	0.29
Vinyl self-insulated 	18RA-250F	100	22–18	0.150	0.250 x 0.032	1	ERG4001	0.96	0.29
	RA257	1,000	22–18	0.150	0.250 x 0.032	1		0.96	0.29
	RA257-170	1,000	22–18	0.170	0.250 x 0.032	1		1.01	0.38
	14RB-250F	100	16–14	0.170	0.250 x 0.032	1		1.01	0.38
	RB257	1,000	16–14	0.170	0.250 x 0.032	1		1.04	0.38
	RB257-200	1,000	16–14	0.200	0.250 x 0.032	1		1.01	0.38
	10RC-250F	50	12–10	0.250	0.250 x 0.032	1		1.04	0.38
Nylon fully insulated 	RC257	500	12–10	0.250	0.250 x 0.032	1	ERG4001	1.01	0.38
	18RA-2577	100	22–18	0.165	0.250 x 0.032	2		1.01	0.38
	RA2573	1,000	22–18	0.165	0.250 x 0.032	2		1.04	0.38
	14RB-2577	50	16–14	0.185	0.250 x 0.032	2		1.01	0.38
	RB2573	1,000	16–14	0.185	0.250 x 0.032	2		1.04	0.38
	10RC-2577	50	12–10	0.225	0.250 x 0.032	2		1.01	0.38
RC2573	500	12–10	0.225	0.250 x 0.032	2	1.04	0.38		

Diagrams

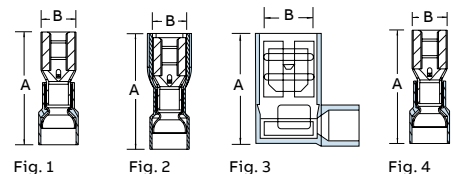





(Continued on next page)

Disconnects and male tabs

Disconnects (continued)

250 Series – Female disconnects (continued)

	Cat. no.	Pkg. qty.	Wire range (AWG)	Max. ins. (in.)	Tab size (in.)	Fig.	Rec. tool	Dimensions (in.)	
								A	B
	RA18-250A	50	22-18	0.170	0.250 x 0.032	3	ERG4001	0.80	0.71
	RA2577F	500	22-18	0.170	0.250 x 0.032	3			
	RB14-250A	50	16-14	0.190	0.250 x 0.032	3		0.80	0.72
	RB2577F	500	16-14	0.190	0.250 x 0.032	3			
	RC10-250A	50	12-10	0.245	0.250 x 0.032	3		0.80	0.88
	RC2577F	500	12-10	0.245	0.250 x 0.032	3			
Non-insulated 	A18-250	100	22-18	-	0.250 x 0.032	1	ERG4002	0.73	0.31
	A250	1,000	22-18	-	0.250 x 0.032	1			
	B14-250	100	16-14	-	0.250 x 0.032	1			
	B250	1,000	16-14	-	0.250 x 0.032	1			
	C10-250F	50	12-10	-	0.250 x 0.032	1			
	C250	500	12-10	-	0.250 x 0.032	1			
Non-insulated/insulation grip 	B14-250F	100	16-14	-	0.250 x 0.032	4	WT110M	0.87	0.31
	B250G	1,000	16-14	-	0.250 x 0.032	4			
Non-insulated 90° flag 	A18-250A	50	22-18	-	0.250 x 0.032	3	ERG4002	0.58	0.61
	A252G	500	22-18	-	0.250 x 0.032	3			
	B14-250A	50	16-14	-	0.250 x 0.032	3	ERG4002	0.58	0.62
	B252G	500	16-14	-	0.250 x 0.032	3			
	C10-250A	50	12-10	-	0.250 x 0.032	3	ERG4005	0.64	0.63
	C252G	500	12-10	-	0.250 x 0.032	3			

Diagrams

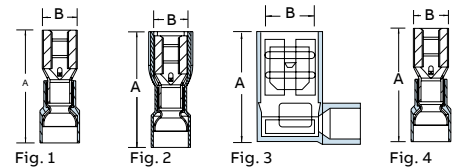

250 Series – Nylon piggy back disconnects



	Cat. no.	Pkg. qty.	Wire range (AWG)	Max. ins. (in.)	Tab size (in.)	Rec. tool	Dimensions (in.)		
							A	B	C
	RA18-250FP	100	22-18	0.136	0.250 x 0.032	WT112M ERG4001	0.87	0.30	0.43
	RA250P	1,000	22-18	0.136	0.250 x 0.032				
	RB14-250FP	100	16-14	0.163	0.250 x 0.032	0.87	0.30	0.43	
	RB250P	1,000	16-14	0.163	0.250 x 0.032				

Diagrams

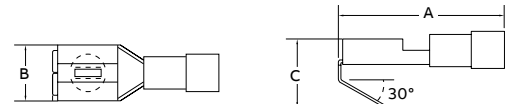





Disconnects and male tabs

Disconnects (continued)

187 Series – Female disconnects



	Cat. no.	Pkg. qty.	Wire range (AWG)	Max. ins. (in.)	Tab size (in.)	Fig.	Rec. tool	Dimensions (in.)	
								A	B
Nylon self-insulated 	RAD18-183	100	22-18	0.136	0.187 x 0.032	1	ERG4001	0.83	0.23
	RAD1833	1,000	22-18	0.136	0.187 x 0.032	1			
	RAD18-182	100	22-18	0.136	0.187 x 0.020	1			
	RAD1823	1,000	22-18	0.136	0.187 x 0.020	1			
	RBD14-183	100	16-14	0.163	0.187 x 0.032	1		0.83	0.23
	RBD1833	1,000	16-14	0.163	0.187 x 0.032	1			
	RBD14-182	100	16-14	0.163	0.187 x 0.020	1			
	RBD1823	1,000	16-14	0.163	0.187 x 0.020	1			
Vinyl self-insulated 	18RAD-183	100	22-18	0.150	0.187 x 0.032	1		0.85	0.23
	RAD1837	1,000	22-18	0.150	0.187 x 0.032	1			
	18RAD-182	100	22-18	0.150	0.187 x 0.020	1			
	RAD1827	1,000	22-18	0.150	0.187 x 0.020	1			
	14RBD-183	100	16-14	0.170	0.187 x 0.032	1		0.85	0.23
	RBD1837	1,000	16-14	0.170	0.187 x 0.032	1			
	14RBD-182	100	16-14	0.170	0.187 x 0.020	1			
	RBD1827	1,000	16-14	0.170	0.187 x 0.020	1			
Nylon fully insulated 	18RAD-18377	100	22-18	0.150	0.187 x 0.032	2		0.89	0.30
	RAD18377	1,000	22-18	0.150	0.187 x 0.032	2			
	18RAD-18277	100	22-18	0.150	0.187 x 0.020	2			
	RAD18277	1,000	22-18	0.150	0.187 x 0.020	2			
	14RBD-18377	100	16-14	0.170	0.187 x 0.032	2		0.89	0.30
	RBD18377	1,000	16-14	0.170	0.187 x 0.032	2			
	14RBD-18277	100	16-14	0.170	0.187 x 0.020	2			
	RBD18277	1,000	16-14	0.170	0.187 x 0.020	2			
Non-insulated 	AD18-183	100	22-18	-	0.187 x 0.032	1	ERG4002	0.64	0.23
	AD183	1,000	22-18	-	0.187 x 0.032	1			
	AD18-182	100	22-18	-	0.187 x 0.020	1			
	AD182	1,000	22-18	-	0.187 x 0.020	1			
	BD14-183	100	16-14	-	0.187 x 0.032	1			
	BD183	1,000	16-14	-	0.187 x 0.032	1			
	BD14-182	100	16-14	-	0.187 x 0.020	1			
	Nylon fully insulated 90° flag 	RAD18-187A	50	22-18	0.150	0.187 x 0.032			
RAD1877F		500	22-18	0.150	0.187 x 0.032	3			
RAD18-188A		50	22-18	0.150	0.187 x 0.020	3			
RAD1887F		500	22-18	0.150	0.187 x 0.020	3			
RBD14-187A		50	16-14	0.170	0.187 x 0.032	3	0.74	0.61	
RBD1877F		500	16-14	0.170	0.187 x 0.032	3			
RBD14-188A		50	16-14	0.170	0.187 x 0.020	3			
RBD1887F		500	16-14	0.170	0.187 x 0.020	3			

Diagrams

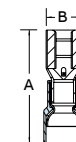

Fig. 1

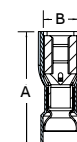

Fig. 2

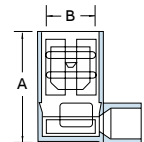

Fig. 3



Disconnects and male tabs

Male tabs

250 Series – Male tabs

Select the tabs you need!

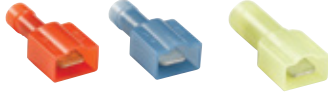

	Cat. no.	Pkg. qty.	Wire range (AWG)	Max. ins. (in.)	Tab size (in.)	Rec. tool	Dimensions (in.)	
							A	B
Vinyl self-insulated 	18RA-250T	100	22-18	0.150	0.250 x 0.032	ERG4001	0.95	–
	RA2517	1,000	22-18	0.150	0.250 x 0.032		0.95	–
	14RB-250T	100	16-14	0.170	0.250 x 0.032		1.08	–
	RB2517	1,000	16-14	0.170	0.250 x 0.032		1.13	0.45
	10RC-250T	50	12-10	0.250	0.250 x 0.032		1.13	0.45
	RC2517	500	12-10	0.250	0.250 x 0.032		1.17	0.45
Nylon fully insulated 	18RA-251T	50	22-18	0.150	0.250 x 0.032	WT110M	0.87	–
	RA25177	500	22-18	0.150	0.250 x 0.032		0.87	–
	14RB-251T	50	16-14	0.170	0.250 x 0.032		0.68	–
	RB25177	500	16-14	0.170	0.250 x 0.032		0.68	–
	10RC-251T	25	12-10	0.210	0.250 x 0.032		0.68	–
	RC25177	500	12-10	0.210	0.250 x 0.032		0.68	–
Non-insulated/insulated grip 	A18-250T	100	22-18	–	0.250 x 0.032	ERG4002	0.68	–
	B14-250T	100	20-14	–	0.250 x 0.032		0.68	–
Non-insulated 	A18-251T	100	22-18	–	0.250 x 0.032	ERG4002	0.68	–
	A251	1,000	22-18	–	0.250 x 0.032		0.68	–
	B14-251T	100	16-14	–	0.250 x 0.032		0.68	–
	B251	1,000	16-14	–	0.250 x 0.032		0.68	–
	C10-251T	50	12-10	–	0.250 x 0.032		0.68	–

Diagram

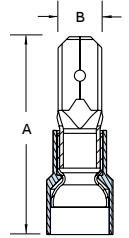

187 Series – Male tabs



	Cat. no.	Pkg. qty.	Wire range (AWG)	Max. ins. (in.)	Tab size (in.)	Rec. tool	Dimensions (in.)	
							A	B
Vinyl insulated 	18RAD-187	100	22-18	0.150	0.187 x 0.032	ERG4001	0.87	–
	18RAD-188	100	22-18	0.150	0.187 x 0.020		0.87	–
	14RBD-187	100	16-14	0.170	0.187 x 0.032		0.87	–
	14RBD-188	100	16-14	0.170	0.187 x 0.020		0.87	–

Diagram

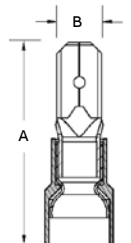



Disconnects and male tabs

250 Series – Adapters and coupler & 110 Series – Disconnects

250 Series – Adapters and coupler†

Insulated coupler requires no tool!

	Cat. no.	Pkg. qty.	Tab size (in.)	Dimensions (in.)	
				A	B
Non-insulated 	F250TA	50	0.250 x 0.032	0.82	0.56
	FTA250	1,000	0.250 x 0.032		
Insulated coupler 	RB14-250	50	0.250 x 0.032	2.35	0.51
	RBB250	500	0.250 x 0.032		

Diagrams

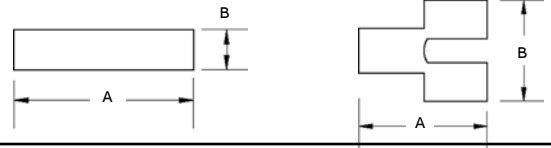

† Not UL* listed



Cat. no. F250TA – Material: brass; Finish: tin plated

Cat. no. RB14-250 – Material: brass; Finish: none; Insulation: vinyl

Disconnects

Available in variety of wire ranges!

110 Series – Disconnects*

	Cat. no.	Pkg. qty.	Wire range (AWG)	Max. ins. (in.)	Tab size (in.)	Rec. tool	Dimensions (in.)	
							A	B
Nylon-insulated 	RA18-110F	100	22-18	0.110	0.110 x 0.032	ERG4006	0.75	0.15
	RA10-SK	1,000	22-18	0.110	0.110 x 0.032			
	RA18-111F	100	22-18	0.110	0.110 x 0.020			
	RA11	1,000	22-18	0.110	0.110 x 0.020			
	RB14-110F	100	16-14	0.135	0.110 x 0.032		0.75	0.15
	RB10-SK	1,000	16-14	0.135	0.110 x 0.032			
	RB14-111F	100	16-14	0.135	0.110 x 0.020			
	RB11-TB	1,000	16-14	0.135	0.110 x 0.020			
Non-insulated 	A18-110F	100	22-18	-	0.110 x 0.032	WT111M WT112M WT2000	0.59	0.15
	A10-TB	1,000	22-18	-	0.110 x 0.032			
	A18-111F	100	22-18	-	0.110 x 0.020			
	A11	1,000	22-18	-	0.110 x 0.020			
	B14-110F	100	16-14	-	0.110 x 0.032			
	B10-TB	1,000	16-14	-	0.110 x 0.032			
	B14-111F	100	16-14	-	0.110 x 0.020			
	B11-TB	1,000	16-14	-	0.110 x 0.020			

Diagram

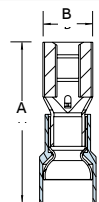



* Not UL listed or CSA approved.

Disconnects and male tabs

Wristlock disconnects

Choose from nylon-insulated or non-insulated!

Wristlock disconnects[†]

	Cat. no.	Pkg. qty.	Wire range (AWG)	Max. ins. (in.)	Rec. tool	Dimensions (in.)	
						A	B
	RA18D	50	22-18	0.136	WT2000	0.99	1.70
	RA23	1,000	22-18	0.136			
	RB14D	50	16-14	0.162		0.99	1.70
	RB23	1,000	16-14	0.162			
	B14-D	50	16-14	0.187	WT110M	0.97	1.66
	B23	1,000	16-14	0.187			

Diagram

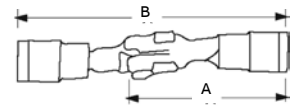

[†] Not UL[®] listed

Picture shows wristlock disconnect assembled as two pieces. Parts are sold by the piece, not by assemblies.

Luminaire disconnects

Disconnect ballasts under load for safe servicing –
In compliance with NEC® requirements.



01 This cutaway shows how the Sta-Kon Luminaire Disconnect grips and holds the pushed-in wires securely after installation.

Push-in luminaire disconnect

Each year, electricians sustain injuries while attempting to change ballasts without tripping the breaker because they're trying to avoid disconnecting other lighting and equipment from power. That's why recent changes to NEC and UL standards require a means of disconnecting power to non-residential fluorescent lighting ballasts.

In 2006, ABB developed the first UL Listed product to meet this need. Now, in response to customer demand, the new Sta-Kon® Push-In Luminaire Disconnect provides all the same safety benefits as the original, but installs even faster and easier.

- Enables electricians changing ballasts to easily disconnect incoming power for safe servicing without having to trip the main power breaker
- Installs easily – just strip de-energized wires and insert
- Disconnect halves snap together and separate easily – But won't accidentally disconnect
- Foolproof design eliminates the potential for incorrect installation and reverse polarity
- Fits through ½" knockouts for easy retrofit

- Ballast hot-lead wire entry is color-coded black for easy visibility
- Finger-safe on both sides
- For use in all non-residential fluorescent lighting applications and in ordinary location HID lighting applications – both up to 600 V, 4 A maximum
- Complies with NEC, CEC, UL® and CSA requirements
- Sold in mated pairs (male/line and female/load sides)

Specifications

- Housing: polycarbonate
- Temperature rating: 105 °C (221 °F) max.
- Electrical rating: 600 V, 4 A max.
- Flammability rating: UL94V-2
- Contacts: copper alloy
- Wire Range: #18–#12 AWG solid copper
#14–#12 AWG stranded copper (19 strands or fewer)
- Standards: complies with 2008 NEC 410.130(G), CEC 30-308(4) and UL 2459
- Certifications: UL listed, CSA certified



Sta-Kon push-in luminaire disconnect



Cat. no.	Description	Std. pkg. qty.
LD2P-Q	2-Wire push-in luminaire disconnect, distributor pack	25
LD2P-D	2-Wire push-in luminaire disconnect, bulk packaging	500

Note: If you prefer lead wires instead of a push-in design and/or need a 3-wire disconnect for switching or dimming applications, order the original Sta-Kon luminaire disconnect, 2-wire Cat. no. LD2 (Cat. no. LD2-D for bulk packaging) or 3-wire Cat. no. LD3 (Cat. no. LD3-D for bulk packaging). See following page.

NEC and National Electrical Code are registered trademarks of the National Fire Protection Association, Inc.

Luminaire disconnects



Meets 2011 NEC[®] requirements for fluorescent fixtures and ballasts!

- Oversized electrical contacts improve conductivity and reduce temperature rise
- Integral wire leads ease installation – even with multiple wire sizes – and support connection to copper or aluminum wiring
- Foolproof design ensures mating halves of disconnect are installed correctly, preventing reverse polarization
- Finger-safe line side protects installer and enables safe servicing without disconnecting power
- Line and load indications clearly identified on each half
- Rounded, compact design fits in tight spaces
- Bright orange for instant identification as a safety device

Specifications

- Housing: polycarbonate
- Contacts: tin-plated brass
- Integral leads: insulated #18 AWG solid copper
- Temp. rating: 105 °C
- Flammability: UL94V-2
- (V-0 available on request)
- Electrical rating: 4 A, 600 V
- Standards: UL[®] listed E07134, CSA certified, NEC section 410.130(G) 2011 edition compliant

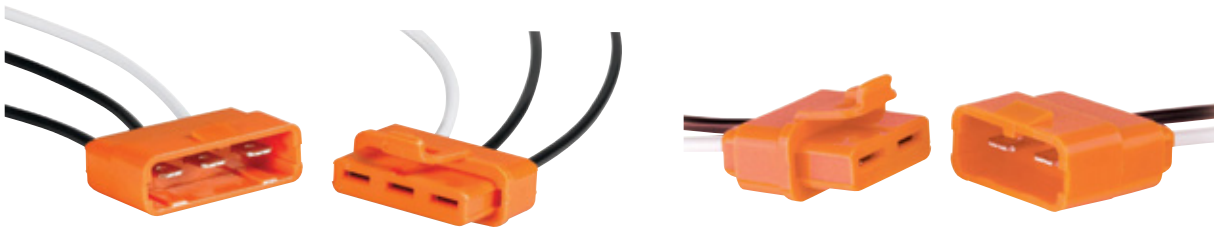

Luminaire disconnects



Cat. no.	Description	Pkg. qty.
Bulk packaging for OEMs		
LD2-D	2-Pole luminaire disconnect	500
LD3-D	3-Pole luminaire disconnect	500
Kits for servicing electricians (includes two male/line half and two female/load half of the luminaire disconnect, polybagged with installation instructions)		
LD2	2-pole luminaire disconnect kit	20
LD3	3-pole luminaire disconnect kit	20

Disconnect installation tool

—
01 This one-of-a-kind tool
may be used to seat all
sizes of ABB disconnects.



—
01

Faster, easier and safer than manual seating of disconnects!

- Perfect for wire-harness assemblers and panel builders
- Dual-ended with slots to fit red and blue (male and female) or yellow disconnects
- Color-coded dots for easy matching of disconnect with correct tool end
- Lightweight and only 5 $\frac{1}{8}$ " long – Fits in a shirt pocket like a pen

Disconnect installation tool

Cat. no.	Description	Pkg. Qty.
DT22-10	Sta-kon® disconnect installation tool	1

Ferrules

Insulated ferrules

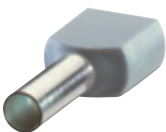

Features

- Ferrules ensure reliable electrical connections when terminating conductors in screw clamp terminal blocks
- Fraying and breaking of wire strands is prevented and the possibility of an unreliable connection is minimized
- Insulated ferrules prevent conductor breakage due to bending, wire stress or vibration, while facilitating wire insertions into the terminal block clamp
- Ferrules are the preferred alternative to twisting wire stands or tinning the wire end before terminating into a terminal block
- Ferrules are thin-walled copper tubes, which are mechanically crimped onto the ends of stranded wires
- They are easy to use – simply strip the wire, slide the ferrule onto the end of the wire and crimp

- Meets emerging global standards, requiring wire-to-metric style terminal block installations to be terminated with a “pin” style terminal
- Vinyl insulated, nylon insulated and non-insulated styles
- All styles offered in #22 AWG to #10 AWG and compatible with existing Sta-Kon® tooling

How to apply a ferrule

- Strip the insulation from the end of the wire and insert into the insulated end of the ferrule
- Using the designated crimping tool, place the metal shaft into the tool's appropriate slot. Compress the tool to make a crescent-shape depression along the length of the ferrule
- Insert the crimped ferrule into the terminal block
- Tighten the ferrule and wire into the terminal block

Materials

- High-conductivity copper
- Tin plating

Insulated ferrules

Cat. no.	Conductor section		Color	Dimensions (in.)/(mm)					Installation tooling	Pkg. qty.
	AWG	mm ²		A	B	ØC	ØD	E		
F4004	26	0.14	Gray	0.413/10.5	0.236/6.0	0.031/0.80	0.079/2.0	0.010/0.25	T3, ERG4	500
F4005	26	0.14	Gray	0.492/12.5	0.315/8.0	0.031/0.80	0.079/2.0	0.010/0.25	T3, ERG4	500
F4006	24	0.25	Yellow	0.413/10.5	0.236/6.0	0.031/0.80	0.079/2.0	0.010/0.25	T3, ERG4	500
F4007	24	0.25	Yellow	0.492/12.5	0.315/8.0	0.031/0.80	0.079/2.0	0.010/0.25	T3, ERG4	500
F4008	22	0.34	Purple	0.413/10.5	0.236/6.0	0.031/0.80	0.079/2.0	0.010/0.25	T3, ERG4	500
F4009	22	0.34	Purple	0.492/12.5	0.315/8.0	0.031/0.80	0.079/2.0	0.010/0.25	T3, ERG4	500
F2020	20	0.50	White	0.453/11.5	0.236/6.0	0.043/1.1	0.098/2.5	0.006/0.15	T1, T3 & ERG4	500
F2021	20	0.50	White	0.531/13.5	0.315/8.0	0.043/1.1	0.098/2.5	0.006/0.15	T1, T3 & ERG4	500
F2022	20	0.50	White	0.610/15.5	0.394/10.0	0.043/1.1	0.098/2.5	0.006/0.15	T1, T3 & ERG4	500
F2023	18	0.75	Gray	0.472/12.0	0.236/6.0	0.051/1.3	0.110/2.8	0.006/0.15	T1, T3 & ERG4	500
F2024	18	0.75	Gray	0.551/14.0	0.315/8.0	0.051/1.3	0.110/2.8	0.006/0.15	T1, T3 & ERG4	500
F2025	18	0.75	Gray	0.630/16.0	0.394/10.0	0.051/1.3	0.110/2.8	0.006/0.15	T1, T3 & ERG4	500
F2026	18	0.75	Gray	0.709/18.0	0.472/12.0	0.051/1.3	0.110/2.8	0.006/0.15	T1, T3 & ERG4	500
F2027	18	1.00	Red	0.492/12.5	0.236/6.0	0.059/1.5	0.118/3.0	0.006/0.15	T1, T3 & ERG4	500
F2028	18	1.00	Red	0.571/14.5	0.315/8.0	0.059/1.5	0.118/3.0	0.006/0.15	T1, T3 & ERG4	500
F2029	18	1.00	Red	0.650/16.5	0.394/10.0	0.059/1.5	0.118/3.0	0.006/0.15	T1, T3 & ERG4	500
F2030	18	1.00	Red	0.728/18.5	0.472/12.0	0.059/1.5	0.118/3.0	0.006/0.15	T1, T3 & ERG4	500

Diagram

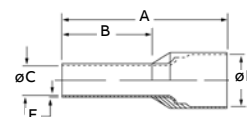

Ferrules

Insulated ferrules (continued)

Insulated ferrules

Cat. no.	Conductor section		Color	Dimensions (in.)/(mm)					Installation tooling	Pkg. qty.
	AWG	mm ²		A	B	ØC	ØD	E		
F2031	16	1.50	Black	0.571/14.5	0.315/8.0	0.071/1.8	0.134/3.4	0.006/0.15	T1, T3 & ERG4	500
F2032	16	1.50		0.650/16.5	0.394/10.0	0.071/1.8	0.134/3.4	0.006/0.15	T1, T3 & ERG4	500
F2033	16	1.50		0.728/18.5	0.472/12.0	0.071/1.8	0.134/3.4	0.006/0.15	T1, T3 & ERG4	500
F2034	16	1.50		0.965/24.5	0.708/18.0	0.071/1.8	0.134/3.4	0.006/0.15	T1, T3 & ERG4	500
F2035	14	2.50	Blue	0.591/15.0	0.315/8.0	0.091/2.3	0.165/4.2	0.006/0.15	T1, T3 & ERG4	500
F2036	14	2.50		0.748/19.0	0.472/12.0	0.091/2.3	0.165/4.2	0.006/0.15	T1, T3 & ERG4	500
F2037	14	2.50		0.984/25.0	0.708/18.0	0.091/2.3	0.165/4.2	0.006/0.15	T1, T3 & ERG4	500
F2038	12	4.00	Gray	0.889/17.5	0.394/10.0	0.114/2.9	0.189/4.8	0.008/0.20	T3 & ERG4	500
F2039	12	4.00		0.787/20.0	0.472/12.0	0.114/2.9	0.189/4.8	0.008/0.20	T3 & ERG4	500
F2040	12	4.00		1.024/26.0	0.708/18.0	0.114/2.9	0.189/4.8	0.008/0.20	T3 & ERG4	100
F2041	10	6.00	Yellow	0.787/20.0	0.472/12.0	0.142/3.6	0.244/6.2	0.008/0.20	T3 & ERG4	100
F2042	10	6.00		0.984/25.0	0.708/18.0	0.142/3.6	0.244/6.2	0.008/0.20	T3 & ERG4	100
F2043	8	10.00	Red	0.827/21.0	0.472/12.0	0.181/4.6	0.295/7.5	0.008/0.20	T3 & ERG4	100
F2044	8	10.00		1.063/27.0	0.708/18.0	0.181/4.6	0.295/7.5	0.008/0.20	T3 & ERG4	100
F2045	6	16.00	Blue	0.906/23.0	0.472/12.0	0.236/6.0	0.346/8.8	0.008/0.20	ERG4	100
F2046	6	16.00		1.142/29.0	0.708/18.0	0.236/6.0	0.346/8.8	0.008/0.20	ERG4	50
F2047	4	25.00	Yellow	1.142/29.0	0.630/18.0	0.295/7.5	0.433/11.0	0.008/0.20	ERG4	50
F2048	4	25.00		1.220/31.0	0.708/18.0	0.295/7.5	0.433/11.0	0.008/0.20	ERG4	50
F2049	4	25.00		1.378/35.0	0.866/22.0	0.295/7.5	0.433/11.0	0.008/0.20	ERG4	50
F2050	2	35.00	Red	1.181/30.0	0.630/16.0	0.335/8.5	0.492/12.5	0.008/0.20	ERG4	50
F2051	2	35.00		1.260/32.0	0.708/18.0	0.335/8.5	0.492/12.5	0.008/0.20	ERG4	50
F2052	2	35.00		1.535/39.0	0.984/25.0	0.335/8.5	0.492/12.5	0.008/0.20	ERG4	50
F2053	1/0	50.00	Blue	1.417/36.0	0.787/20.0	0.413/10.5	0.591/15.0	0.014/0.35	ERG4	50
F2054	1/0	50.00		1.614/41.0	0.984/25.0	0.413/10.5	0.591/15.0	0.014/0.35	ERG4	50

Diagram

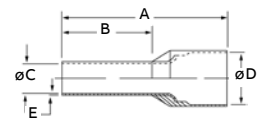

Ferrule dimensions conform to DIN 46228, Part 4.

Ferrules

Strip lengths on insulated ferrules

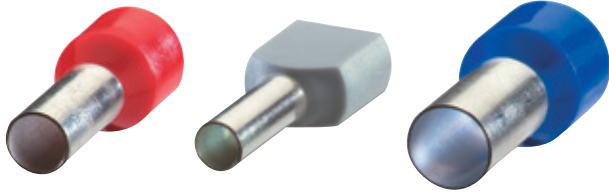

Strip lengths on insulated ferrules

Cat. no.	Dimensions (in.)		
	Pin length	Min. strip length	Max. strip length
F2020	0.236	0.3147	0.354
F2021	0.315	0.3937	0.433
F2022	0.394	0.4727	0.512
F2023	0.236	0.3147	0.354
F2024	0.315	0.3937	0.433
F2025	0.394	0.4727	0.512
F2026	0.472	0.5507	0.59
F2027	0.236	0.3147	0.354
F2028	0.315	0.3937	0.433
F2029	0.394	0.4727	0.512
F2030	0.472	0.5507	0.59
F2031	0.315	0.3937	0.433
F2032	0.394	0.4727	0.512
F2033	0.472	0.5507	0.59
F2034	0.708	0.7867	0.826
F2035	0.315	0.3937	0.433
F2036	0.472	0.5507	0.59
F2037	0.708	0.7867	0.826
F2038	0.394	0.4727	0.512
F2039	0.472	0.5507	0.59
F2040	0.708	0.7867	0.826
F2041	0.472	0.5507	0.59
F2042	0.708	0.7867	0.826
F2043	0.472	0.5507	0.59
F2044	0.708	0.7867	0.826
F2045	0.472	0.5507	0.59

Note: The thicker the insulation, the longer the strip length should be.

Cat. no.	Dimensions (in.)		
	Pin length	Min. strip length	Max. strip length
F2046	0.708	0.7867	0.826
F2047	0.63	0.7087	0.748
F2048	0.708	0.7867	0.826
F2049	0.866	0.9447	0.984
F2050	0.53	0.6087	0.648
F2051	0.708	0.7867	0.826
F2052	0.984	1.0627	1.102
F2053	0.787	0.8657	0.905
F2054	0.984	1.0627	1.102
F4000	0.315	0.3937	0.433
F4001	0.315	0.3937	0.433
F4002	0.315	0.3937	0.433
F4003	0.315	0.3937	0.433
F4004	0.236	0.3147	0.354
F4005	0.315	0.3937	0.433
F4006	0.236	0.3147	0.354
F4007	0.315	0.3937	0.433
F4008	0.236	0.3147	0.354
F4009	0.315	0.3937	0.433
F4020	0.315	0.3937	0.433
F4021	0.315	0.3937	0.433
F4022	0.315	0.3937	0.433
F4023	0.315	0.3937	0.433
F4024	0.315	0.3937	0.433
F4027	0.315	0.3937	0.433
F4028	0.315	0.3937	0.433

Ferrules

Insulated twin ferrules



Insulated twin ferrules

Cat. no.	Conductor section		Colors	Dimensions (in.)/(mm)					Installation tooling	Pkg. qty.
	AWG	mm ²		A	B	ØC	ØD	E		
F8000	2 x 20	2 x 0.50	White	0.591/15.0	0.315/8.0	0.059/1.5	0.177/4.5	0.010/0.25	T3	500
F8001	2 x 18	2 x 0.75	Gray	0.591/15.0	0.315/8.0	0.071/1.8	0.201/5.1	0.010/0.25	T3	500
F8002	2 x 18	2 x 0.75		0.669/17.0	0.394/10.0	0.071/1.8	0.201/5.1	0.006/0.15	T3	500
F8003	2 x 17	2 x 1.00	Red	0.591/15.0	0.315/8.0	0.081/2.05	0.201/5.1	0.006/0.15	T3	500
F8005	2 x 17	2 x 1.00	Black	0.669/17.0	0.394/10.0	0.081/2.05	0.201/5.1	0.006/0.15	T3	500
F8006	2 x 16	2 x 1.50		0.630/16.0	0.315/8.0	0.091/2.3	0.252/6.4	0.006/0.15	T3	500
F8007	2 x 16	2 x 1.50	Blue	0.787/20.0	0.472/12.0	0.091/2.3	0.252/6.4	0.006/0.15	T3	500
F8008	2 x 14	2 x 2.50		0.728/18.5	0.394/10.0	0.114/2.9	0.295/7.5	0.006/0.15	T3	500
F8009	2 x 14	2 x 2.50	Gray	0.846/21.5	0.512/13.0	0.114/2.9	0.295/7.5	0.006/0.15	T3	500
F8010	2 x 12	2 x 4.00		0.906/23.0	0.472/12.0	0.150/3.8	0.339/8.6	0.006/0.15	ERG4/6MM DIE	100
F8011	2 x 10	2 x 6.00	Yellow	0.984/25.0	0.551/14.0	0.193/4.9	0.378/9.6	0.008/0.20	ERG4/10MM DIE	100

Diagram

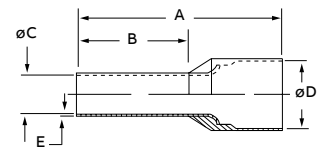

Ferrule dimensions conform to DIN 46228, part 4.

Ferrules

Insulated ferrules & Tooling for Sta-Kon® insulated ferrules



Insulated ferrules (old DIN and French standards)

Diagram	Cat. no.	Conductor section			Colors	Dimensions (in.)/(mm)					Installation tooling	Pkg. qty.
		Style	AWG	mm ²		A	B	ØC	ØD	E		
	F4000	Old DIN	20	0.50	Orange	0.571/14.5	0.315/8.0	0.043/1.1	0.102/2.6	0.006/0.15	T1, T3 & ERG4	500
	F4001	Old DIN	18	0.75	White	0.571/14.5	0.315/8.0	0.051/1.3	0.110/2.8	0.006/0.15	T1, T3 & ERG4	500
	F4002	Old DIN	18-17	1.00	Yellow	0.571/14.5	0.315/8.0	0.059/1.5	0.118/3.0	0.006/0.15	T1, T3 & ERG4	500
	F4003	Old DIN	16	1.50	Red	0.571/14.5	0.315/8.0	0.071/1.8	0.134/3.4	0.006/0.15	T1, T3 & ERG4	500
	F4020	Old DIN	14	2.50	Blue	0.571/14.5	0.315/8.0	0.091/2.3	0.165/4.2	0.006/0.15	T1, T3 & ERG4	500
	F4021	French	20	0.50	White	0.571/14.5	0.315/8.0	0.043/1.1	0.102/2.6	0.006/0.15	T1, T3 & ERG4	500
	F4023	French	18	0.75	Lt. Blue	0.571/14.5	0.315/8.0	0.051/1.3	0.110/2.8	0.006/0.15	T1, T3 & ERG4	500
	F4024	French	18-17	1.00	Red	0.571/14.5	0.315/8.0	0.059/1.5	0.118/3.0	0.006/0.15	T1, T3 & ERG4	500
	F4027	French	16	1.50	Black	0.571/14.5	0.315/8.0	0.071/1.8	0.134/3.4	0.006/0.15	T1, T3 & ERG4	500
	F4028	French	14	2.50	Gray	0.571/14.5	0.315/8.0	0.091/2.3	0.165/4.2	0.006/0.15	T1, T3 & ERG4	500

Ferrule dimensions conform to DIN 46228, part 4.

The crimping tools you need!

01 T1
02 T3
03 ERG4

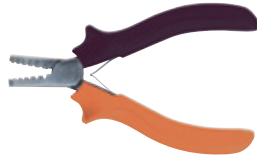

01



02



03

Tooling for Sta-Kon insulated ferrules

Cat. no.	Description	Pkg. qty.
T1	Sta-Kon crimp tool for wire ferrules #20-#14 AWG - Insulated handle	1
T3	Sta-Kon crimp tool for wire ferrules #26-#10 AWG - Insulated handle	1
ERG4	Comfort Crimp® Sta-Kon crimp tool with Shure-Stake® mechanism, for installing wire ferrules #26-1/0 AWG; Four interchangeable die sets included; Insulated handle; Packaged in sturdy plastic carrying case	1

Ferrules

Non-insulated ferrules



Non-insulated ferrules

Diagram	Cat. no.	Conductor section		Dimensions (in.)/(mm)				Installation tooling	Pkg. qty.
		AWG	mm ²	A	C	D	E		
	F9000	24	0.25	0.196/5	0.030/0.75	0.067/1.7	0.006/0.15	T1, ERG4 T3	1,000
	F9001	22	0.5	0.236/6	0.039/1.0	0.083/2.1	0.006/0.15	T1, T3, ERG4	1,000
	F9002	22	0.5	0.394/10	0.039/1.0	0.083/2.1	0.006/0.15	T1, T3, ERG4	1,000
	F9003	18	0.75	0.236/6	0.047/1.2	0.091/2.3	0.006/0.15	T1, T3, ERG4	1,000
	F9004	18	0.75	0.394/10	0.047/1.2	0.091/2.3	0.006/0.15	T1, T3, ERG4	1,000
	F9005	18	1	0.236/6	0.055/1.4	0.098/2.5	0.006/0.15	T1, T3, ERG4	1,000
	F9006	18	1	0.394/10	0.055/1.4	0.098/2.5	0.006/0.15	T1, T3, ERG4	1,000
	F9007	16	1.5	0.276/7	0.067/1.7	0.110/2.8	0.006/0.15	T1, T3, ERG4	1,000
	F9008	16	1.5	0.394/10	0.067/1.7	0.110/2.8	0.006/0.15	T1, T3, ERG4	1,000
	F9009	16	1.5	0.473/12	0.067/1.7	0.110/2.8	0.006/0.15	T1, T3, ERG4	1,000
	F9010	16	1.5	0.709/18	0.067/1.7	0.110/2.8	0.006/0.15	T1, T3, ERG4	1,000
	F9011	14	2.5	0.276/7	0.087/2.2	0.139/3.4	0.006/0.15	T1, T3, ERG4	1,000
	F9012	14	2.5	0.394/10	0.087/2.2	0.139/3.4	0.006/0.15	T1, T3, ERG4	1,000
	F9013	14	2.5	0.472/12	0.087/2.2	0.139/3.4	0.006/0.15	T1, T3, ERG4	1,000
	F9014	14	2.5	0.709/18	0.087/2.2	0.139/3.4	0.006/0.15	T1, T3, ERG4	1,000
	F9015	12	4	0.354/9	0.110/2.8	0.158/4	0.008/0.2	T3, ERG4	1,000
	F9016	12	4	0.472/12	0.110/2.8	0.158/4	0.008/0.2	T3, ERG4	1,000
	F9017	12	4	0.591/15	0.110/2.8	0.158/4	0.008/0.2	T3, ERG4	1,000
	F9018	12	4	0.709/18	0.110/2.8	0.158/4	0.008/0.2	T3, ERG4	1,000
	F9019	10	6	0.472/12	0.138/3.5	0.185/4.7	0.008/0.2	T3, ERG4	1,000
	F9020	10	6	0.591/15	0.138/3.5	0.185/4.7	0.008/0.2	T3, ERG4	1,000
	F9021	10	6	0.709/18	0.138/3.5	0.185/4.7	0.008/0.2	T3, ERG4	1,000
	F9022	8	10	0.472/12	0.177/4.5	0.228/5.8	0.008/0.2	ERG4	500
	F9023	8	10	0.591/15	0.177/4.5	0.228/5.8	0.008/0.2	ERG4	500
	F9024	8	10	0.709/18	0.177/4.5	0.228/5.8	0.008/0.2	ERG4	500
	F9025	6	16	0.472/12	0.228/5.8	0.295/7.5	0.008/0.2	ERG4	250
	F9026	6	16	0.591/15	0.228/5.8	0.295/7.5	0.008/0.2	ERG4	250
	F9027	6	16	0.709/18	0.228/5.8	0.295/7.5	0.008/0.2	ERG4	250
	F9028	6	16	0.984/25	0.228/5.8	0.295/7.5	0.008/0.2	ERG4	250
	F9029	6	16	1.26/32	0.228/5.8	0.295/7.5	0.008/0.2	ERG4	250
	F9030	4	25	0.591/15	0.287/7.3	0.374/9.5	0.010/0.25	ERG4	100
	F9031	4	25	0.709/18	0.287/7.3	0.374/9.5	0.010/0.25	ERG4	100
	F9032	4	25	0.984/25	0.287/7.3	0.374/9.5	0.010/0.25	ERG4	100
	F9033	4	25	1.26/32	0.287/7.3	0.374/9.5	0.010/0.25	ERG4	100
	F9034	2	35	0.709/18	0.327/8.3	0.433/11	0.010/0.25	ERG4	100
	F9035	2	35	0.984/25	0.327/8.3	0.433/11	0.010/0.25	ERG4	100
	F9036	2	35	1.26/32	0.327/8.3	0.433/11	0.010/0.25	ERG4	100
	F9037	1/0	50	0.709/18	0.406/10.3	0.512/13	0.012/0.3	TB5095, ERG4	100
	F9038	1/0	50	0.984/25	0.406/10.3	0.512/13	0.012/0.3	TB5095, ERG4	100
F9039	1/0	50	1.18/30	0.406/10.3	0.512/13	0.012/0.3	TB5095, ERG4	100	

Wire termination tools and installation kits

Sta-Kon® mini-pack terminals



Convenient 20-count packaging!

- Wire ranges from #22 AWG to #10 AWG
- Vinyl insulated ring and forked-tongued terminals, female disconnects, butt-type splice connectors

Note: "CP" designates mini-pack quantities. Refer to other catalog pages for description and dimensional information.

Sta-Kon mini-pack terminals

Cat. no.	Colors	Unit qty.	Pkg. qty.	Wire range (AWG)	Bolt hole (in.)
18RA-6FCP	Red	20	100	22-18	#6
18RA-8CP	Red	20	100	22-18	#8
18RA-10CP	Red	20	100	22-18	#10
14RB-6CP	Blue	20	100	16-14	#6
14RB-8CP	Blue	20	100	16-14	#8
14RB-10CP	Blue	20	100	16-14	#10
10RC-10CP	Yellow	20	100	12-10	#10
10RC-14CP	Yellow	20	100	12-10	¼
18RA-8FCP	Red	20	100	22-18	#8
18RA-10FCP	Red	20	100	22-18	#10
14RB-6FCP	Blue	20	100	16-14	#6
14RB-8FCP	Blue	20	100	16-14	#8
14RB-10FCP	Blue	20	100	16-14	#10
10RC-8FCP	Yellow	20	100	12-10	#8
10RC-10FCP	Yellow	20	100	12-10	10
2RA18XCP	Red	20	100	22-18	-
2RB14XCP	Blue	20	100	16-14	-
2RC10XCP	Yellow	20	100	12-10	-
18RA-250FCP	Red	20	100	22-18	-
14RB-250FCP	Blue	20	100	16-14	-
10RC-250FCP	Yellow	20	100	12-10	-

Wire termination tools and installation kits

Sta-Kit® installing kit & Sta-Org® terminal and splice organizer kit



Perfect for residential or light commercial installations!

- Assortment of popular Sta-Kon® vinyl terminals
- Kit includes a WT112M crimping tool
- Includes cable ties and wire marker book

Sta-Kit installing kit

Cat. no.	Description	Pkg. qty.
STAKIT	Assortment of Sta-Kon vinyl terminals, splices and disconnects – Includes crimp tool, cable ties and wire book marker	1



Lightweight, durable, nylon construction!

- Ideal for contractors, OEMs or any other user of terminals and splices
- Slips in a tool box or sits on your bench – Only 6.6"L x 3" dia.
- Bench-mountable (hardware included)

Kit contents:

- Blue nylon organizer/carrier x 1
- See-through nylon canisters with lids x 6
- #12–#10 AWG vinyl ring terminals (Cat. no. 10RC-10) x 20

- #18–#14 AWG vinyl ring terminals (Cat. no. 14RB-10) x 25
- #12–#10 AWG vinyl butt splices (Cat. no. 2RC-10X) x 15
- #18–#14 AWG vinyl butt splices (Cat. no. 2RB-14X) x 25
- #12–#10 AWG vinyl fork terminals (Cat. no. 10RC-10F) x 20
- #18–#14 AWG vinyl fork terminals (Cat. no. 14RB-10F) x 25

Sta-Org terminal and splice organizer kit

Cat. no.	Description	Pkg. qty.
STA-ORG	Sta-Kon Sta-Org terminal and splice organizer kit	1

Wire termination tools and installation kits

Recommended tools



The Shure-Stake® mechanism on mechanical ratchet tools and power tools prevents the dies from releasing the terminal until the proper compression has been completed. With this method, an operator achieves a reliable crimp every time. ABB tooling techniques correctly match tools, wire size and terminal to produce optimum mechanical and electrical performance.

—
01 Plier type if installations are fewer than 20 per day – WT112M



—
01

—
02 Ratchet type if installations are more than 20 per day – ERG4001



—
02





—
03 Power type if installations are more than 200 per day – 12050



—
03

Plier-type tools

Used for installation of various Sta-Kon® terminal series.

		Cat. no.	For use with Sta-Kon series	Pkg. qty.
WT110M		WT110M	A, B, C non-insulated terminal and splices and A, B non-insulated terminals with insulation grip	1
		WT111M	A, B, C, PT non-insulated terminal and splices; includes cutters	1
WT112M		WT112M	A, B, C non-insulated and RA, RB, RC insulated nylon and vinyl terminal and splices; includes cutters	1
		WT161M	A, B, C, PT non-insulated terminal and splices; includes plier grip and cutters	1
WT2000		WT2000	A, B, C, AB, PT, RA, RB, RC insulated and non-insulated terminal and splices; includes wire cutters, bolt cutters and wire stripper	1

Wire termination tools and installation kits

Comfort Crimp® compression tools

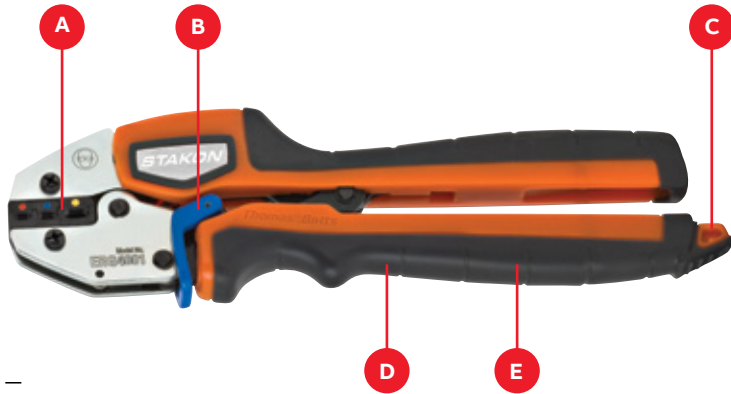

A Color-coded die nests (left and right side) provided for proper crimping of insulated terminals

B Shure-Stake mechanism ensures a proper crimp every time

C Crimp-Assist foot provides stability when work surface leverage is needed to crimp larger connectors

D Ergonomically advanced, soft, over-molded handle grips reduce strain and enhance user comfort

E Requires the lowest handle force of any tool in its class – 25% less than the previous generation of Comfort Crimp tools

Features





- Perfect for OEM, MRO and field use
- UL listed for use with Sta-Kon® connectors
- Shure-Stake® mechanism ensures a complete crimp cycle before release for a proper crimp every time
- Color-coded die nests for easy matching with Sta-Kon insulated terminals
- Creates integrity dots for quick verification of proper crimp
- Advanced manufacturing methods for improved durability and tool life
- Lanyard hole in handle for easy tethering to workstation
- Calibration service available through ABB Tool Services

Sta-Kon Comfort Crimp Compression Tools previously set the standard for manual crimp tools. Now, ABB engineers have made a great line of tools even better with the newly redesigned Sta-Kon Comfort Crimp Compression Tools. We kept all the performance features that made the tools industry leaders such as the Shure-Stake mechanism and interchangeable dies with color-coded die nests, and focused on creating the best possible user experience in terms of comfort and reduction of strain.

Ergonomic handles position the user's hands correctly to minimize the risk of strain, and soft, over-molded grips cushion fingers and palm for user comfort. A new Crimp-Assist™ foot stabilizes the tool when the user needs to place it on a work surface for leverage to crimp larger connectors. Best of all, the redesigned Comfort Crimp tools require 25% less handle force to complete the crimp cycle than the previous generation – And up to 75% less handle force than competing tools!

Requiring the lowest handle force of any tool in its class, the new Comfort Crimp family provides maximum comfort to installers, without sacrificing the durability or performance associated with ABB tools.

Comfort Crimp compression tools

		Cat. no.	For use with Sta-Kon series	Pkg. qty.
ERG4002	ERG4007	ERG4001	RA, RB, RC nylon & vinyl terminals, splices & disconnects	1
		ERG4002	A, B, C non-insulated terminals, splices, disconnects	1
		ERG4004	A, B and C flag terminals	1
		ERG4005	B, C, D, E non-insulated terminals, splices, (D & E tubular only)	1
ERG4004	ERG4008	ERG4006	RA, RB 0.110 disconnects and RZ Terminals	1
		ERG4007	RD & RE insulated terminals (tubular only)	1
		ERG4008	Non-insulated terminals #8-1/0 AWG (tubular only)	1
ERG4005				
				

Note: Contact tool services for gauging.

Wire termination tools and installation kits

Comfort Crimp® compression tools



WT1377 Ratchet hand tool

Cat. no.	For use with Sta-Kon series	Pkg. qty.
WT1377	NW ring terminals	1

Correct compression every time – The Shure-Stake® mechanism principle prevents opening of the handles until full staking action is completed. Installs self-insulated and non-insulated Sta-Kon® terminal series in the #26-#10 AWG wire range.



WT2130A Ratchet hand tool

Cat. no.	For use with Sta-Kon series	Pkg. qty.
WT2130A	RC, RBC and RD insulated terminals, RC6, RP7 wire joints	1



ERG4006 Hand tool

Cat. no.	For use with Sta-Kon series	Pkg. qty.
ERG4006	RZ terminals/splices RA, RB 0.110 insulated disconnects	1



WT3185 Ratchet hand tool

Cat. no.	For use with Sta-Kon series	Pkg. qty.
WT3185	For #8 AWG to 250 kcmil non-insulated Sta-Kon Terminals joints	1

Note: For gauging information, contact Tool Services.



ERG4255 Ratchet hand tool

Cat. no.	For use with Sta-Kon series	Pkg. qty.
ERG4255	RA, RB, RC heat-shrinkable nylon-insulated terminals, butt splices, and disconnects	1



WT129 Flag terminal type hand tool

Cat. no.	For use with Sta-Kon series	Pkg. qty.
WT129	D, E, F & G non-insulated flag terminals Sta-Kon Terminals joints	1

Wire termination tools and installation kits

Wire stripping/cutting tools and toggle-type hand tool

01 SWS01

02 DWS02



01

02

Single operation to cut and strip at the same time!

- Automatic adjustment to the diameter of the wire, with neither setting nor selection
- Sharply cuts and strips insulator without damaging the conductors
- DWS02 is a double-side stripper

SWS01/DWS02 Wire stripping/cutting tools

Cat. no.	Description	Pkg. qty.
SWS01	Single-side stripper	1
DWS02	Double-side stripper	1

01 ERG1-WS

02 "V" blade cassette



01

02

Integral wire cutter lets user cut and strip with the same tool!

- Interchangeable cassettes enable the user to strip a wide range of insulations without having to change tools
- Tool automatically strips wire to preset length

Sta-Kon® ERG1-WS Wire stripping/cutting tool

Cat. no.	Description	Pkg. qty.
ERG1-WS	Ergonomic wire stripping tool	1
VBC-1	Replacement "V" blade cassette	1

ERG1-WS Wire stripping/cutting tool is shipped with one straight blade cassette (SBC-1). "V" blade cassettes sold separately.



WT115A Toggle-type hand tool

Cat. no.	For use with Sta-Kon® series	Pkg. qty.
WT115A	D, E, F & G non-insulated terminals	1

Wire termination tools and installation kits

TBM6 & TBM6S toggle-type hand tools

Installing dies for non-insulated code and Aircraft Sta-Kon® terminals

Cat. no.		
Nest stationary die	Indenter movable die	Term. size
11803	-	D, E (tubular)
11805	-	E (brazed), F (tubular)
11806	11802	F (brazed), G
11807	-	H
11808	-	J
11809	-	K
11810	-	L
11811	-	M

Installing dies for nylon-insulated Sta-Kon terminals TBM6 & TBM6S tools

Die set cat. no.	Term. size
11821	RD (tubular)
11822	RD (brazed seam) RE (tubular)
11823	RF
11824	RG
11825	RH
11826	RJ
11827	RK
11828	RL
11829	RM

TBM6 & TBM6S Toggle-type hand tools

	Cat. no.	For use with Sta-Kon series	Pkg. qty.
TBM6	TBM6	D through M, RD through RM	1
	TBM6S	D through M, RD through RM with Shure-Stake®	1



Dies not included.

Note: This tool can also be used to crimp Blackburn® Lugs and Splices.
See the Color-Keyed® compression connectors catalog.

Wire termination tools and installation kits

Shure-Stake® auto-feed tool



Safe, fast, high-volume crimping machine!

- Shure-Stake mechanism
- Fully guarded foot pedal
- Clear plastic safety guard over die area
- Dies color coded to terminals
- #26–#10 AWG wire range
- Installs insulated and non-insulated terminals and disconnects

Installing dies for 12050

Die cat. no.	Sta-Kon® terminal type	AWG wire size	Pkg. qty.
12051	RA – Nylon	22–18	1
12054*	RA – Vinyl	22–18	1
12061	RA disconnect	22–18	1
12052	RB – Nylon	16–14	1
12055*	RB – Vinyl	16–14	1
12062	RB disconnect	16–14	1
12056	RC – Nylon and vinyl insulated	12–10	1
12057	A – Non-insulated	22–18	1
12058	B – Non-insulated	16–14	1
12059	C – Non-insulated	12–10	1
12060	C Disconnect, non-insulated	12–10	1

* Can also be used on nylon.

Shure-Stake® auto-feed tool

Cat. no.	Description	Pkg. qty.
12050	Compact, pneumatically operated unit for crimping tape-mounted Sta-Kon terminals; equipped with a Shure-Stake mechanism, which ensures a full compression each time	1

Space requirement: 30" W x 20" H x 20" D

Weight: 55 lbs.

Air pressure: 90–125 psi input air supply

Wire termination tools and installation kits

Battery-powered crimping tool – BAT22-6

01 Easy to rotate with your wrist – Delivers fast and effective crimping power.

02 Uses the exact dies of the Comfort Crimp® line of ergonomic tools for Sta-Kon and Dragon Tooth terminals.

1½ tons of grip that weighs less than three pounds!

ABB's newest battery-powered tool is fast and portable for making high-volume and difficult-to-reach terminal installations in a snap. The Sta-Kon® BAT22-6 delivers 1.5 tons of crimping force with an easy, pushbutton trigger. The lightweight, ergonomic design minimizes the risk of repetitive motion injuries that can occur with traditional hand crimping tools. And at less than three pounds, one-hand operation is easy while still packing enough power to crimp up to #6 AWG terminals in seconds.

- Interchangeable dies can be quickly changed to crimp non-insulated and insulated terminals up to #6 AWG
- Dies are the same as our hand tools – Crimps will be exactly the same between Sta-Kon hand tools such as our ERG4001 and the BAT22-6
- 360° rotating head gives the user the added flexibility when crimping hard-to-reach connections

- Short cycle time equates to crimping times of less than two seconds
- Quick, lightweight and maneuverable
- NiCd battery operation provides long-lasting battery life to complete up to 150 crimps on a single charge
- Extra battery and charger are included with the tool, ensuring round-the-clock operation
- Battery charger provides full battery life in under an hour
- Linear crimping motion gives a symmetric, high-quality crimp every time

Included accessories:

- Sturdy, plastic carrying case for portability
- Two 9.6 V NiCd batteries and battery charger
- Sturdy tray for convenient storage of crimp dies



01



02

Battery-powered crimping tool – BAT22-6

Cat. no.	Description	Pkg. qty.
BAT22-6	Battery crimping tool, 1.5 ton with 120 V AC charger	1
Crimp dies*		
DIE2001	Insulated #22–#10 AWG Sta-Kon terminals	1
DIE2002	Non-insulated #22–#10 AWG Sta-Kon terminals	1
DIE2005	Non-insulated #16–#14/#12–#10/#8–#6 Sta-Kon terminals (tubular only)	1
DIE2007	Insulated #8–#6 AWG Sta-Kon terminals (tubular only)	1

*Dies sold separately.

Note: Battery-powered tools BPI42300CR, BPLT6BSCR and BPLT62BSCR can also be used to crimp non-insulated Sta-Kon terminals. See the Color-Keyed® compression connectors catalog.

Wire termination tools and installation kits

PAIR22-6 Heavy-duty portable air crimp tool



Portable heavy-duty air tool.

- 1.25 tons output force at 100 psi
- Crimps #22–#6 AWG terminals
- Installs Sta-Kon® terminals as well as ferrules and Dragon Tooth® connectors
- Interchangeable dies
- Open yoke enables easy access to insert and remove terminals for crimping

PAIR22-6 Heavy-duty portable air crimp tool

Cat. no.	Description	Pkg. qty.
PAIR22-6	Open yoke, hand actuated	1
Crimp dies*		
DIE2001	Insulated #22–#10 AWG Sta-Kon terminals	1
DIE2002	Non-insulated #22–#10 AWG Sta-Kon terminals	1
DIE2005	Non-insulated #16–#10/#8–#6 AWG Sta-Kon terminals (tubular only)	1
DIE2007	Insulated #8–#6 AWG Sta-Kon terminals (tubular only)	1

* Dies sold separately.

Note: The dies for the BAIR22-6, PAIR22-6 and BAT22-6 are interchangeable.

Note: Battery-powered tools BPI42300CR, BPLT6BSCR and BPLT62BSCR can also be used to crimp non-insulated Sta-Kon terminals.

See the Color-Keyed® compression connectors catalog.

Wire termination tools and installation kits

BAIR22-6 Bench-mounted air tool & Air-operated bench-mounted tool



Crimps #22–#6 AWG terminals!

- 1.8 tons output force at 100 psi
- Bench-mounted heavy-duty air tool
- Short cycle time
- Shure-Stake® mechanism
- Foot actuated

- Accepts ABB standard hand tool dies
- Installs Sta-Kon® and Spec-Kon® terminals as well as ferrules and Dragon Tooth® connectors

BAIR22-6 Bench-mounted air tool

Cat. no.	Description	Pkg. qty.
BAIR22-6	Heavy-duty, high-speed production tool installs a wide range of Sta-Kon terminals, from #26–#6 gauge; uses the DIE2000 series dies for both non-insulated and insulated terminals; supplied complete with foot pedal, air hose/air lubricator	1
Crimp dies*		
DIE2001	Insulated #22–#10 AWG Sta-Kon terminals	1
DIE2002	Non-insulated #22–#10 AWG Sta-Kon terminals	1
DIE2005	Non-insulated #16–#10/#8–#6 AWG Sta-Kon terminals (tubular only)	1
DIE2007	Insulated #8–#6 AWG Sta-Kon terminals (tubular only)	1

* Dies sold separately.

Note: The dies for the BAIR22-6, PAIR22-6 and BAT22-6 are interchangeable.

Note: Battery-powered tools BPI42300CR, BPLT6BSCR and BPLT62BSCR can also be used to crimp non-insulated Sta-Kon terminals.

See the Color-Keyed® compression connectors catalog.



Crimps #8 AWG–250 kcmil!

Convenience and economy

The tool accepts a full range of interchangeable dies, the same as used in the TBM6 or TBM6S tools. To install the dies, simply pull the spring-loaded pin and remove the indentor die. Then, flex the retaining spring and remove the die nest.

Shure-Stake mechanism means quality connections

The Shure-Stake mechanism senses inlet air pressure, and if insufficient, is designed to prevent the tool from cycling. Thus you avoid “undercrimping.” An 85–90-psi air pressure source is required.

Safety features increase productivity, reduce downtime

Safety features include a guard over the die area, an air shutdown switch activated by a slight push with the finger and a foot pedal that’s enclosed to prevent accidental tool operation. In addition, the tool may be bench-mounted for stability and control. For convenience when crimping large size terminals on heavy wire, the head assembly may overhang the workbench.

Air-operated bench-mounted tool

Cat. no.	Description	Pkg. qty.
25000	This compact heavy-duty air tool installs nylon insulated Sta-Kon terminals on wire sizes from #8 AWG to 250 kcmil; non-insulated styles are also installed just as quickly and dependably; heavy-duty air tool installs non-insulated and insulated Sta-Kon terminals from #8 AWG to 250 kcmil	1

Note: This tool uses the same dies as the TBM6 and TBM6S hand tools on page 58.

Wire termination tools and installation kits
 12-ton hydraulic head & 12-ton crimping tool



Installs insulated and non-insulated Sta-Kon® terminals!

12-ton hydraulic head

Cat. no.	Description	Pkg. qty.
13400	12-ton crimping tool supplied with adapter TBM12D-AR is used for installing both insulated and non-insulated Sta-Kon terminals #8 AWG to 250 kcmil (dies ordered separately)	1

Diagram

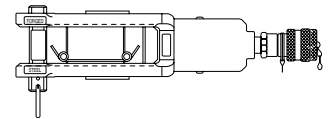

Military listed and 12 tons of crimping power!

12-ton crimping tool (Military spec. MS25441-1)

Cat. no.	Description	Pkg. qty.
13642M	Hydraulic-operated 12-ton tool installs #8 AWG through 250 kcmil Sta-Kon terminals (dies ordered separately)	1

Wire termination tools and installation kits

Dies

Hex dies for non-insulated Sta-Kon® terminals to fit 13642M and 13400

Die cat. no.				
For tubular term	For brazed seam	Sta-Kon size	Wire size (AWG)	Hex die code
11732	-	D	8	21
-	11733	D	8	24
11733	-	E	6	24
-	11734	E	6	29
11734	-	F	4	29
-	11735	F	4	33
11736	-	G	2-1	37
11737	-	H	1/0	42
11738	-	J	2/0	45
11739	-	K	3/0	50
11740	-	L	4/0	54
11771	-	M	250 kcmil	62

Installing dies for insulated Sta-Kon terminals to Fit 13642M (military listed)

Die cat. no.	Sta-Kon size	Wire size (AWG)	Pkg. qty.
21707M	RD	8	1
21708M	RE	6	1
21709M	RF	4	1
21710M	RG	2-1	1
21711M	RH	1/0	1
21712M	RJ	2/0	1
21713M	RK	3/0	1
21714M	RL	4/0	1
21715M	RM	250 kcmil	1

Hex dies for non-insulated Sta-Kon terminals to fit 13642M (military listed)

Die cat. no.	Sta-Kon size	Wire size (AWG)	Pkg. qty.
11781M	D	8	1
11782M	E	6AN	1
11783M	F	4AN	1
11784M	G	2AN	1
11785M	H	1AN	1
11786M	J	1/0AN	1
11787M	K	2/0AN	1
11788M	L	3/0AN	1
11789M	M	4/0AN	1

Wire termination tools and installation kits

Dies

Indent style dies for Sta-Kon® brazed seam non-insulated terminals to fit 13642M and 13400

Nest cat. no.	Indent. cat. no.	Sta-Kon size	Wire size (AWG)	Pkg. qty.
13643	13650	D	8	1
13644		E	6	1
13645		F	4	1

Indent style dies for Sta-Kon tubular non-insulated terminals to fit 13642M and 13400

Nest cat. no.	Indent. cat. no.	Sta-Kon size	Wire size (AWG)	Pkg. qty.
13654	13650	G	2-1	1
13655		H	1/0	1
13656		J	2/0	1
13657		K	3/0	1
13658		L	4/0	1
13659		M	250 kcmil	1

Indent style dies for flag type Sta-Kon terminals – Use with 13642M and 13400

Nest cat. no.	Indent. cat. no.	Sta-Kon size	Wire size (AWG)	Pkg. qty.
21733	21731	D	8	1
21734		E	6	1
21735		F	4	1
21736	21732	G	2	1
21737		H	1	1
21738		J	1/0	1
21739**		K	2/0	1
21740**		L	3/0	1
21741**		M	4/0	1

** Cat. nos. 21739, 21740 and 21741 dies must be left in 13642 head with 21732 indenter when gauging.

Wire termination tools and installation kits

Electric hydraulic pumps



- Designed for use with single-acting cylinders and tools rated for 10,000-psi operation
- Supplied with metal carrying case
- 13620 hand switch and 13619 hydraulic hose, both sold separately, required for operation

Specifications

- Motor: ½ hp, 115 V 50–60 Hz, 10 A
- Pumping capacity:
 - 170 cu. in./min. at 100 psi
 - 32 cu. in./min. at 1,000 psi
 - 25 cu. in./min. at 5,000 psi
 - 18 cu. in./min. at 10,000 psi
- Reservoir volume: 104 cu. in. (0.45 gal.)
- Basic pump dimension: 6" x 8" x 16"
- Weight: 25 lbs.

13600 Electric hydraulic pump

Cat. no.	Description	Pkg. qty.
13600	Electric hydraulic pump – Hand or foot switch and non-metallic hose (sold separately) required for operation	1



- Shure-Stake® control mechanism requires 9,800-psi pump pressure before recycling to prevent under-crimping
- Designed for use with single-acting cylinders and tools rated for 10,000-psi operation
- Supplied with metal carrying case

Specifications

- Motor rating: ½ hp, 115 V, 50–60 Hz, 12.5 A
- Pumping capacity:
 - 170 cu. in./min. at 100 psi
 - 32 cu. in./min. at 1,000 psi
 - 25 cu. in./min. at 5,000 psi
 - 18 cu. in./min. at 10,000 psi
- Reservoir volume: 104 cu. in. (0.45 gal.)
- Basic pump dimension:
 - 8½" x 10½" x 16"
- Weight: 35 lbs.

13610A Electric hydraulic pump with Shure-Stake control

Cat. no.	Description	Pkg. qty.
13610A	Electric hydraulic pump with Shure-Stake control – Hand or foot switch and non-metallic hose (sold separately) required for operation	1

Wire termination tools and installation kits

Electric hydraulic pumps and accessories



- Designed for perfect crimps every time in heavy-duty OEM applications
- Heavy-duty OEM two-stage pump with high flow rate
- Shure-Stake® control mechanism requires 9,800-psi pump pressure before recycling to prevent under-crimping
- Requires hand or foot control (sold separately)

Specifications

- Motor rating: 1½ hp, 115 V, 60 Hz, 23 A
- Pumping capacity:
235 cu. in./min. at 200 psi
6 cu. in./min. at 8,000 psi
- Reservoir volume: 462 cu. in./2 gal.
- Dimensions (L x W x H): 10¾" x 15" x 20¾"
- Weight: 60 lbs.

13810 Heavy-duty electric hydraulic pump with Shure-Stake control

Cat. no.	Description	Pkg. qty.
13810	Heavy-duty electric hydraulic pump with Shure-Stake control – Hand or foot switch and non-metallic hose (sold separately) required for operation	1

Accessories for pumps 13600, 13610A and 13810

Cat. no.	Description	Pkg. qty.
You may also need...for 13600		
13620	Hand switch	1
13589A	Foot switch	1
13619	10-ft. non-metallic hose	1
13618	20-ft. non-metallic hose	1
13600S	"Sled" type stand for 13600 pump	1
You may also need...for 13610A & 13810		
13611	Hand switch	1
13612	Foot switch	1
13619	10-ft. non-metallic hose	1
13618	20-ft. non-metallic hose	1

Wire termination technical information

Platings/finish & Sta-Kon® technical data

Electroplated-tin is standard finish. All others require minimum order quantities and are generally not stocked. Alternative platings are as follows: gold, silver, tin-alloys, nickel or plain finish. See table (below) for specification information.

Platings/finish

Finish	Suffix	Spec.	Temp. rating
Gold plate	GP	MIL-G-45204 Type II, Grade B, C, D, Class O	150 °C
Nickel plate	NP	QQ-N-290 Class 2, Grade G	260 °C
Plain finish	PF	None	150 °C
Silver plate	SP	MIL-T-16366 Type I or II, 400 °F, 204 °C	150 °C

Listing

Sta-Kon rings, forks and locking forks are tested and listed to UL® 486A, two-way splices to UL 486C, disconnects to UL 310 and all applicable products to CSA 22.2.

Sta-Kon technical data



Terminals & splices insulation rating	UL 94 flammability	Voltage	Temperature
Nylon	V-2	600 V*	105 °C
Vinyl	V-0	600 V*	105 °C
Tefzel®	V-0	600 V*	150 °C
Disconnects	–	300 V	105 °C
Non-insulated	–	600 V	150 °C

*1000 V fixture or sign

Minimum pull-out test – UL 486A and UL 486C

Wire termination technical information

Installation procedure

01 Shure-Stake® tools are matched to terminals – ERG4001



01

The proper installation procedure for the quality-assured connection!

The proper installation of terminals, splices and connectors is very important to the efficient performance of an electrical system. The properly installed connector will enable good conductivity through the termination. Certain basic requirements must be met to make a good termination.

- Strip the insulation carefully to avoid nicking or cutting conductor strands
- Strip the insulation to the proper length so the conductors can be inserted fully into the connector barrel; the wire/cable should be visible in the inspection hole of the lug; the proper strip length can be found on page 74.

A poor termination results in a high-resistance connection. A poor connector installation may cause damage or failure of an entire system.

1. Strip the insulation carefully to avoid nicking or cutting conductor strands.
2. Strip the insulation to the proper length so the conductors can be inserted fully into the connector barrel; the wire/cable should be visible in the inspection hole of the lug; the proper strip length can be found on page 74.
3. Train the wires to eliminate fanning of strands.
4. Open handles fully.
5. Insert terminal in proper die nest and locate it as shown above. When crimping a butt splice, position in proper die nest with window facing indenter.
6. Close handles slightly to secure terminal. Do not deform terminal.
7. Insert properly stripped wire into terminal.
8. Complete crimp by closing handles.

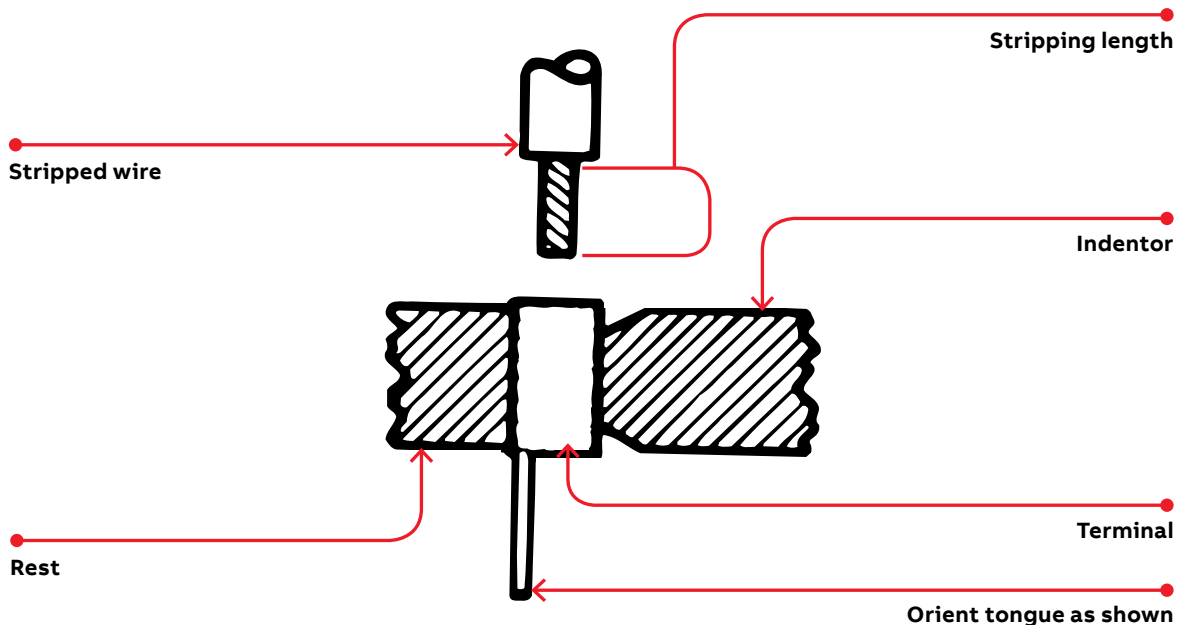

Wire termination technical information

Product selection guide

Product selection guide

Type	Terminal series	Pliers					Ergonomic ratchet hand tools					
		WT110M	WT111M	WT112M	WT161M	WT2000	ERG4001	ERG4002	ERG4004	ERG4005	ERG4006	ERG4255
Nylon terminals	RZ	-	-	-	-	-	-	-	-	-	•	-
	RA, RAX	-	-	•	-	•	•	-	-	-	-	-
	RB	-	-	•	-	•	•	-	-	-	-	-
	RBC, RC	-	-	•	-	•	•	-	-	-	-	-
Nylon butt splices	RA	-	-	•	-	•	•	-	-	-	-	-
	RB	-	-	•	-	•	•	-	-	-	-	-
	RC	-	-	•	-	•	•	-	-	-	-	-
Nylon parallel splices	RAA	-	-	-	-	•	-	-	-	-	-	-
	RBB	-	-	-	-	•	-	-	-	-	-	-
	RCC	-	-	-	-	•	-	-	-	-	-	-
All nylon disconnects (except 0.110 size)	RA	-	-	•	-	•	•	-	-	-	-	-
	RB	-	-	•	-	•	•	-	-	-	-	-
	RC	-	-	•	-	•	•	-	-	-	-	-
Heat-shrinkable terminals, splices & disconnects	RAS	-	-	-	-	-	-	-	-	-	-	•
	RBS	-	-	-	-	-	-	-	-	-	-	•
	RCS	-	-	-	-	-	-	-	-	-	-	•
Vinyl terminals and splices	RA, RAA	-	-	•	-	•	•	-	-	-	-	-
	RB, RBB	-	-	•	-	•	•	-	-	-	-	-
	RC, RCC, RBC	-	-	•	-	•	•	-	-	-	-	-
Bare terminals and splices	A, AA	•	•	•	•	•	-	•	-	-	-	-
	B, BB	•	•	•	•	•	-	•	-	•	-	-
	C, CC	•	•	•	•	•	-	•	-	•	-	-
Wire joints	RB	-	-	•	-	•	•	-	-	-	-	-
	RC	-	-	•	-	•	-	-	-	-	-	-
	RP	-	-	•	-	•	-	-	-	-	-	-
	PT	-	•	-	•	-	-	-	-	-	-	-
Hi-temp terminals and splices	NW-rings	-	-	-	-	-	-	-	-	-	-	-
	NW-splices	-	-	-	-	-	-	-	-	-	-	-
Insulation grip	A	•	-	-	-	-	-	-	-	-	-	-
	B	•	-	-	-	-	-	-	-	-	-	-
0.110 disconnects	A, B	•	•	•	-	-	-	-	-	-	-	-
	RA, RB	-	-	-	-	-	-	-	-	-	•	-
Flag terminals	AB	-	-	-	-	-	-	-	•	-	-	-
	C	-	-	-	-	-	-	-	•	-	-	-
Tefzel® terminals and splices	RAT, RAAT	-	-	•	-	•	-	-	-	-	-	-
	RB, RBBT	-	-	•	-	•	-	-	-	-	-	-
	RC, RCCT	-	-	•	-	•	-	-	-	-	-	-
Vinyl disconnects	RA	-	-	•	-	•	•	-	-	-	-	-
	RB	-	-	•	-	•	•	-	-	-	-	-
	RC	-	-	•	-	•	•	-	-	-	-	-
Bare disconnects	A	•	•	•	•	•	-	•	-	-	-	-
	B	•	•	•	•	•	-	•	-	•	-	-
	C	•	•	•	•	•	-	•	-	•	-	-

Tefzel is a registered trademark of DuPont.

Wire termination technical information

Select the die numbers you need

Select the die numbers you need

Description	Series	Terminal Type	Hand tool with dies	25000 air tool TBM6 toggle hand tool TBM6S toggle hand tool die Cat. nos.		BPI42300CR, BPLT6BSCR and BPLT62BSCR crimp tools		13642M (MS25441-1) and 13400 hydraulic tool		
				Nest (stationary)	Indentor (movable)	Hex dies	Die code	Hex dies	Nest	Indentor
Non-insulated terminals and splices	D	Tubular	ERG4005	11803	11802	-	-	11781M*	13651	13650**
	D	Tubular	ERG4008	11803	11802	-	-	11781M*	13651	13650**
	D	Tubular	WT3185/WT115A	11803	11802	TBM6221	21	11732	13651	13650**
	D	Brazed	WT3185/WT115A	11803	11802	TBM6224	24	11733	13643	13650**
	E	Tubular	ERG4005	11803	11802	-	-	11782M	13652	13650**
	E	Tubular	ERG4008	11803	11802	-	-	11782M	13652	13650**
	E	Tubular	WT3185/WT115A	11803	11802	TBM6224	24	11733*	13652	13650**
	E	Brazed	WT3185/WT115A	11804	11802	TBM6229	29	11734	13644	13650**
	F	Tubular	ERG4008	11805	11802	-	-	11783	13653	13650**
	F	Tubular	WT3185/WT115A	11805	11802	TBM6229	29	11734*	13653	13650**
	F	Brazed	WT3185/WT115A	11806	11802	TBM6233	33	11735	13645	13650**
	G	Tubular	ERG4008	11806	11802	-	-	11784M*	13654	13650**
	G	Tubular	WT3185/WT115A	11806	11802	TBM6237	37	11736	13654	13650**
	H	Tubular	ERG4008	11807	11802	-	-	11785M*	13655	13650**
	H	Tubular	WT3185	11807	11802	-	-	11785M*	13655	13650**
	H	Tubular	WT3185	11807	11802	TBM6242	42	11737	13655	13650**
	J	Tubular	WT3185	11808	11802	-	-	11786M*	13656	13650**
	J	Tubular	WT3185	11808	11802	TBM6245	45	11738	13656	13650**
	K	Tubular	-	11809	11802	-	-	11787M*	13657	13650**
	K	Tubular	-	11809	11802	TBM6250	50	11739	13657	13650**
L	Tubular	-	11810	11802	-	50	11788M*	13658	13650**	
L	Tubular	-	11810	11802	TBM6254	54	11740	13658	13650**	
M	Tubular	-	11811	11802	-	54	11789M*	13659	13650**	
M	Tubular	-	11811	11802	TBM6262	62	11771	13659	13650**	
Tefzel** nylon insulated terminals and splices	RD	Tubular	ERG4007	-----	11821 (Set)	-	-	-----	21707M* (Set)	
	RD	Brazed & tubular	-	-----	11822 (Set)	-	-	-----	21708M* (Set)	
	RE	Tubular	ERG4007	-----	11822 (Set)	-	-	-----	21708M* (Set)	
	RE	Brazed	-	-----	11823 (Set)	-	-	-----	21709M* (Set)	
	RF	Tubular	-	-----	11823 (Set)	-	-	-----	21709M* (Set)	
	RF	Brazed	-	-----	11824 (Set)	-	-	-----	21710M* (Set)	
	RG	Tubular	-	-----	11824 (Set)	-	-	-----	21710M* (Set)	
	RH	Tubular	-	-----	11825 (Set)	-	-	-----	21711M* (Set)	
	RJ	Tubular	-	-----	11826 (Set)	-	-	-----	21712M* (Set)	
	RK	Tubular	-	-----	11827 (Set)	-	-	-----	21713M* (Set)	
	RL	Tubular	-	-----	11828 (Set)	-	-	-----	21714M* (Set)	
RM	Tubular	-	-----	11829 (Set)	-	-	-----	21715M* (Set)		

* Indicates military listed die.

** To order the military version, suffix the indentor catalog number with an "M" (13650M). Nest catalog number does not change.

†Tefzel is a registered trademark of DuPont.

Wire termination technical information

Select the die numbers you need

Select the die numbers you need

Description	Series	Terminal Type	Hand tool with dies	25000 air tool TBM6 toggle hand tool TBM6S toggle hand tool die Cat. nos.		BPI42300CR, BPLT6BSCR and BPLT62BSCR crimp tools		13642M (MS25441-1) and 13400 hydraulic tool		
				Nest (stationary)	Indentor (movable)	Hex dies	Die code	Hex dies	Nest	Indentor
Non-insulated flag terminals	D	-	WT129	-	-	-	-	-	21733	21731
	E	-	WT129	-	-	-	-	-	21734	21731
	F	-	WT129	-	-	-	-	-	21735	21731
	G	-	WT129	-	-	-	-	-	21736	21732
	H	-	-	-	-	-	-	-	21737	21732
	J	-	-	-	-	-	-	-	21738	21732
	K	-	-	-	-	-	-	-	21739	21732
	L	-	-	-	-	-	-	-	21740	21732
	M	-	-	-	-	-	-	-	21741	21732

* Indicates military listed die.

** To order the military version, suffix the indentor catalog number with an "M" (13650M). Nest catalog number does not change.

[†]Tefzel is a registered trademark of DuPont.

Stud size and clearance hole chart

Stud size	2	4	6	8	10	¼	⅜	½	⅝	¾	1	1¼
Min. hole dia. (In.)	0.92	0.116	0.143	0.169	0.196	0.262	0.323	0.388	0.453	0.516	0.650	0.775
Min. hole dia. (mm)	2.337	2.946	3.632	4.292	4.978	6.655	8.204	9.855	11.506	13.106	16.510	19.685

Wire termination technical information

Wire strip length chart

Wire strip length chart

Wire strip length	Terminal series	Recommended wire strip length "A" standard terminals (in.)
Non-insulated	A	$\frac{3}{4}$
	B	$\frac{3}{4}$
	C, BC	$\frac{5}{16}$
Vinyl insulated – Add $\frac{1}{16}$ " for funnel entry type	RA	$\frac{3}{4}$
	RB	$\frac{3}{4}$
	RC, RBC	$\frac{11}{32}$
Nylon insulated and Tefzel® insulated	RA	$\frac{7}{32}$
	RB	$\frac{7}{32}$
	RC, RBC	$\frac{5}{16}$
Nylon insulated and Tefzel insulated when using aircraft and code wire	RD	$\frac{17}{32}$
	RE	$\frac{17}{32}$
	RF	$\frac{9}{16}$
	RG	$\frac{11}{16}$
	RH	$\frac{11}{16}$
	RJ	$\frac{3}{4}$
	RK	$\frac{7}{8}$
	RL	$\frac{7}{8}$
Non-insulated, when using aircraft code wire	RM	1
	D	$\frac{15}{32}$
	E	$\frac{15}{32}$
	F	$\frac{1}{2}$
	G	$\frac{41}{64}$
	H	$\frac{43}{64}$
	J	$\frac{47}{64}$
	K	$\frac{55}{64}$
L	$\frac{55}{64}$	
M	$\frac{59}{64}$	

Diagram

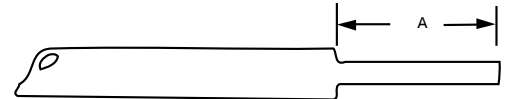

Wire termination technical information

Wire termination technical information

AWG or AN	Individual strands			Whole conductor		
	Navy shipboard [†]	No.	Dia. (in.)	Cir. mil. area	Dia. (in.)	Dia. (mm)
22 Wire size						
22	3/8 (1)	1	0.025	642	0.025	0.635
22	3/8 (7)	7	0.010	703	0.030	0.762
AN-22*	–	7	**	704	0.032	0.813
–	1/2 (21)	21	0.005	525	0.028	0.711
20 Wire size						
20	1 (1)	1	0.032	1,022	0.032	0.813
20	–	7	0.012	1,024	0.036	0.914
20	–	10	0.010	1,005	0.040	1.016
20	–	19	0.007	1,022	0.037	0.940
20	–	26	0.006	1,034	0.039	0.991
AN-20*	–	7	**	1,119	0.040	1.016
–	1 (7)	7	0.013	1,119	0.038	0.965
–	1 (10)	10	0.010	1,005	0.038	0.965
–	1 (26)	26	0.006	1,034	0.042	1.067
18 Wire size						
18	1 1/2 (1)	1	0.040	1,624	0.040	1.016
18	1 1/2 (7)	7	0.016	1,624	0.049	1.245
18	1 1/2 (16)	16	0.010	1,608	0.049	1.245
18	–	19	0.009	1,624	0.046	1.168
18	1 1/2 (41)	41	0.006	1,630	0.049	1.245
AN-18*	2 (7)	7	0.016	1,779	0.048	1.219
16 Wire size						
16	2 1/2 (1)	1	0.051	2,583	0.051	1.295
16	–	7	0.019	2,583	0.058	1.473
16	–	19	0.012	2,601	0.058	1.473
16	–	26	0.010	2,613	0.059	1.499
16	–	65	0.006	2,580	0.058	1.473
AN-16*	2 1/2 (19)	19	0.011	2,407	0.061	1.549
–	2 1/2 (26)	26	0.010	2,613	0.061	1.549
14 Wire size						
14	–	1	0.064	4,107	0.064	1.626
14	–	7	0.024	4,107	0.073	1.854
14	–	19	0.015	4,107	0.074	1.880
14	–	37	0.011	4,107	0.074	1.880
14	–	14	0.009	4,157	0.083	2.108
14	–	104	0.006	4,128	0.074	1.880
AN-14*	–	19	**	3,830	0.076	1.930
–	3 (7)	7	0.020	2,828	0.060	1.524
–	3 (19)	19	0.013	3,036	0.063	1.600
–	4 (1)	1	0.064	4,107	0.064	1.626
–	4 (7)	7	0.025	4,497	0.076	1.930
–	4 (19)	19	0.014	3,828	0.072	1.829
–	4 (41)	41	0.010	4,121	0.077	1.956

AWG or AN	Individual strands			Whole conductor		
	Navy shipboard [†]	No.	Dia. (in.)	Cir. mil. area	Dia. (in.)	Dia. (mm)
12 Wire size						
12	–	1	0.081	6,530	0.081	2.057
12	–	7	0.031	6,530	0.092	2.337
12	–	19	0.019	6,530	0.093	2.362
12	–	37	0.013	6,530	0.093	2.362
12	–	49	0.012	6,593	0.104	2.642
12	–	65	0.010	6,533	0.093	2.362
12	–	104	0.008	6,574	0.094	2.388
12	–	165	0.006	6,559	0.095	2.413
AN-12*	6 (19)	19	0.018	6,088	0.096	2.438
–	6 (7)	7	0.031	6,512	0.092	2.337
–	6 (65)	65	0.010	6,533	0.097	2.964
10 Wire size						
10	–	1	0.102	10,380	0.102	2.591
10	–	7	0.039	10,380	0.116	2.946
10	–	19	0.023	10,380	0.117	2.972
10	–	37	0.017	10,443	0.117	2.972
10	–	49	0.015	10,445	0.131	2.327
10	–	104	0.010	10,452	0.116	2.946
AN-10*	–	37	**	10,380	0.117	2.972
–	9 (7)	7	0.036	9,016	0.108	2.743
–	9 (37)	37	0.016	9,402	0.109	2.769
–	9 (90)	90	0.010	9,045	0.120	3.048

* MIL-W-5086.

** Strand diameter not specified.

† MIL-E-16366 A.

Wire termination technical information

AWG or AN	Navy shipboard [†]	Individual strands			Whole conductor	
		No.	Dia. (in.)	Cir. mil. area	Dia. (in.)	Dia. (mm)
9 Wire size						
9	–	7	0.043	13,090	0.130	3.302
–	14 (7)	7	0.045	14,340	0.136	3.454
8 Wire size						
8	–	7	0.049	16,510	0.146	3.712
8	–	19	0.030	16,510	0.148	3.763
8	–	37	0.021	16,510	0.148	3.763
7 Wire size						
7	–	1	0.144	20,820	0.144	3.662
–	14 (7)	7	0.045	14,340	0.136	3.454
–	14 (140)	140	0.010	14,070	0.145	3.787
6 Wire size						
6	–	7	0.061	25,250	0.184	4.672
6	–	19	0.037	26,250	0.186	4.722
6	–	37	0.027	26,250	0.186	4.722
6	–	49	0.023	26,146	0.208	5.283
6	–	661	0.006	26,274	0.259	6.579
5 Wire size						
5	–	1	0.181	33,100	0.181	4.595
–	20 (49)	7 x 7	0.020	19,800	0.180	4.570
–	23 (7)	7	0.057	22,800	0.171	4.345
–	23 (228)	19 x 12	0.010	22,190	0.190	4.830
–	26 (49)	7 x 7	0.023	26,250	0.210	5.330
4 Wire size						
4	–	7	0.077	41,740	0.232	5.891
4	–	19	0.047	41,740	0.235	5.967
4	–	37	0.034	41,740	0.235	5.967
3 Wire size						
3	–	1	0.229	52,630	0.229	5.819
–	30 (304)	19 x 16	0.010	30,550	0.220	5.590
–	33 (336)	7 x 48	0.010	33,370	0.235	5.967
–	40 (19)	19	0.045	38,910	0.226	5.742
–	42 (49)	7 x 7	0.029	41,740	0.260	6.600
–	42 (209)	19 x 11	0.014	42,110	0.260	6.600
–	50 (19)	19	0.051	49,080	0.254	6.452
2 Wire size						
2	–	7	0.097	66,370	0.292	7.421
2	–	19	0.059	66,370	0.296	7.522
2	–	37	0.042	66,370	0.297	7.548
2	–	49	0.037	66,356	0.331	8.405
2	–	133	0.022	66,140	0.335	8.507
AN-2*	–	663	**	66,832	0.345	8.767
–	53 (532)	19 x 28	0.010	53,470	0.304	7.772
–	60 (37)	37	0.040	60,090	0.282	7.161

* MIL-W-5086.

** Strand diameter not specified.

† MIL-E-16366 A

Wire termination technical information

AWG or AN	Navy shipboard [†]	Individual strands			Whole conductor	
		No.	Dia. (in.)	Cir. mil. area	Dia. (in.)	Dia. (mm)
2 Wire size (cont.)						
–	60 (304)	19 x 16	0.014	61,260	0.310	7.870
–	66 (133)	19 x 7	0.022	66,370	0.330	8.380
–	75 (37)	37	0.045	75,780	0.317	8.048
1 Wire size						
1	–	7	0.109	83,690	0.328	8.333
1	–	19	0.066	83,690	0.332	8.431
1	–	37	0.048	83,690	0.333	8.456
1	–	61	0.037	83,690	0.333	8.456
1	–	133	0.025	83,690	0.377	9.578
1	–	259	0.018	83,916	0.378	9.603
AN-1*	–	812	**	81,807	0.384	9.752
–	83 (418)	19 x 22	0.014	84,230	0.380	9.650
–	84 (2,107)	2107	**	83,690	0.410	10.41
1/0 Wire size						
1/0	–	7	0.123	105,500	0.368	9.343
1/0	–	19	0.075	105,500	0.373	9.476
1/0	–	37	0.053	105,500	0.374	9.502
1/0	–	61	0.042	105,500	0.374	9.502
1/0	–	133	0.028	105,761	0.423	10.721
1/0	–	259	0.020	105,672	0.424	10.772
AN-0*	–	1,033	**	104,118	0.432	10.971
–	100 (61)	61	0.040	99,060	0.363	9.216
–	105 (259)	37 x 7	**	105,500	0.410	10.410
2/0 Wire Size						
–	105 (2,646)	2,646	**	105,500	0.460	11.680
2/0	–	7	0.138	133,100	0.414	10.512
2/0	–	19	0.084	133,100	0.419	10.639
2/0	–	37	0.060	133,100	0.420	10.670
2/0	–	61	0.047	133,100	0.420	10.670
2/0	–	133	0.032	132,800	0.474	12.042
2/0	–	259	0.023	133,462	0.477	12.118
AN-00*	–	1,327	**	133,665	0.490	12.450
–	125 (61)	61	0.045	124,900	0.407	10.338
–	133 (259)	37 x 7	**	133,100	0.460	11.680
–	133 (684)	19 x 36	0.014	137,800	0.480	12.190
–	133 (3,325)	3,325	**	133,100	0.520	13.210
–	150 (61)	61	0.051	157,600	0.457	11.608
3/0 Wire size						
3/0	–	7	0.155	167,800	0.464	11.782
3/0	–	19	0.094	167,800	0.470	11.940
3/0	–	37	0.067	167,800	0.471	11.965
3/0	–	61	0.052	167,800	0.472	11.991
3/0	–	133	0.036	167,607	0.533	13.536

* MIL-W-5086.

** Strand diameter not specified.

† MIL-E-16366 A

Wire termination technical information

AWG or AN	Navy shipboard†	Individual strands			Whole conductor	
		No.	Dia. (in.)	Cir. mil. area	Dia. (in.)	Dia. (mm)
3/0 Wire size (cont.)						
3/0	–	259	0.026	167,402	0.536	13.612
3/0	–	4,227	0.006	168,023	0.610	15.490
–	150 (760)	19 x 40	0.014	153,100	0.510	12.950
–	168 (427)	61 x 7	**	167,800	0.520	13.210
4/0 Wire size						
4/0	–	7	0.174	211,600	0.522	13.261
4/0	–	19	0.106	211,600	0.528	13.413
4/0	–	37	0.076	211,600	0.529	13.439
4/0	–	61	0.059	211,600	0.530	13.460
4/0	–	133	0.040	211,736	0.599	15.219
4/0	–	259	0.029	211,845	0.601	15.265
AN-000*	–	1,661	**	167,332	0.548	13.923
–	200 (61)	61	0.057	198,700	0.514	13.652
–	200 (988)	19 x 52	0.014	199,100	0.580	14.730
250 kcmil Wire size						
250,000	–	19	0.115	250,000	0.574	14.582
250,000	–	37	2	250,000	0.575	14.607
250,000	–	61	0.064	250,000	0.576	14.632
250,000	–	91	0.052	250,000	0.576	14.632
AN-0000*	–	2,104	**	211,954	0.615	15.617
–	220 (259)	37 x 7	0.029	220,700	0.610	15.490
–	250 (61)	61	0.064	250,000	0.577	14.658

* MIL-W-5086.

** Strand diameter not specified.

† MIL-E-16366 A.

Wire termination technical information

MIL-T-7928 MS-25036	Cat. no. ABB class 1 & 2	MIL-T-7928 MS-25036	Cat. no. ABB class 1 & 2	MIL-T-7928 MS-20659	Cat. no. ABB class 1 & 2	MIL-T-7928 MS-21004	Cat. no. ABB
-101	RA333	-148	RA323	-146	G926	-1	A486
-102	RA853	-149	RA863	-147	G972	-2	A483
-103	RA873	-150	RA713	-148	G974	-3	A482
-104	RA723	-151	RA753	-149	H972	-4	A481
-105	RA733	-152	RB1323	-151	J972	-5	A485
-106	RB1333	-153	RB863	-152	J974	-6	A484
-107	RB853	-154	RB713	-153	K971	-7	A480
-108	RB873	-155	RB753	-154	K974	-8	B486
-109	RB723	-156	RC863	-155	L972	-9	B483
-110	RB733	-157	RC713	-156	L974	-10	B482
-111	RC333	-158	RC753	-157	M972	-11	B481
-112	RC363			-158	M974	-12	B485
-113	RC703			-165	C33	-13	B484
-114	RC733			-166	C75	-14	B480
-115	RD10361					-15	C486
-116	RD10711					-16	C483
-117	RD10721					-17	C482
-118	RD10731					-18	C481
-119	RE10261					-19	C485
-120	RE10711					-20	C484
-121	RE10721					-21	C480
-122	RE10731						
-123	RF10711						
-124	RF10721						
-125	RF10731						
-126	RG9711						
-127	RG9731						
-128	RG9751						
-129	RH9711						
-130	RH9731						
-131	RH9751						
-132	RJ9711						
-133	RJ9731						
-135	RK9721						
-136	RK9731						
-137	RK9751						
-138	RL9731						
-139	RL9751						
-140	RM9731						
-141	RM9751						
-142	-						
-143	-						
-144	-						
-145	-						
-146	-						
-147	-						

MIL-T-7928 MS-20659	Cat. no. ABB class 1 & 2	MIL-T-7928 MS-20659	Cat. no. ABB class 1 & 2
-101	A85G	-101	A85G
-102	A87G	-102	A87G
-103	B85G	-103	B85G
-104	B87G	-104	B87G
-105	C26	-105	C26
-106	C70	-106	C70
-107	D10361	-107	D10361
-108	D10721	-108	D10721
-109	E10711	-109	E10711
-110	E10731	-110	E10731
-111	F10711	-111	F10711
-112	F10731	-112	F10731
-113	G971	-113	G971
-114	G973	-114	G973
-115	H971	-115	H971
-116	H973	-116	H973
-117	J971	-117	J971
-118	J973	-118	J973
-119	K972	-119	K972
-120	K973	-120	K973
-121	L973	-121	L973
-122	L975	-122	L975
-123	M973	-123	M973
-124	M975	-124	M975
-128	C73	-128	C73
-129	D10731	-129	D10731
-130	E10261	-130	E10261
-131	E10721	-131	E10721
-132	F10721	-132	F10721
-133	G975	-133	G975
-134	H975	-134	H975
-135	J975	-135	J975
-136	K975	-136	K975
-140	D10161	-140	D10161
-141	D10711	-141	D10711
-144	F10261	-144	F10261

MIL-T-22909 MS-90485	Cat. no. ABB	MIL-T-22909 MS-90485	Cat. no. ABB
-8	11781M	-8	11781M
-6	11782M	-6	11782M
-4	11783M	-4	11783M
-2	11784M	-2	11784M
-1	11785M	-1	11785M
-01	11786M	-01	11786M
-02	11787M	-02	11787M
-03	11788M	-03	11788M
-04	11789M	-04	11789M

MIL-T-7928 MS-17143	Cat. no. ABB	MIL-T-7928 MS-17143	Cat. no. ABB
-1	RA480	-1	RA480
-2	RB480	-2	RB480
-3	RC480	-3	RC480
-4	RA481	-4	RA481
-5	RB481	-5	RB481
-6	RC481	-6	RC481
-7	RA482	-7	RA482
-8	RB482	-8	RB482
-9	RC482	-9	RC482
-10	RA483	-10	RA483
-11	RB483	-11	RB483
-12	RC483	-12	RC483
-13	RA484	-13	RA484
-14	RB484	-14	RB484
-15	RC484	-15	RC484
-16	RA485	-16	RA485
-17	RB485	-17	RB485
-19	RA486	-19	RA486
-20	RB486	-20	RB486

MIL-T-22909 -MS-23002	Cat. no. ABB	MIL-T-22909 -MS-23002	Cat. no. ABB
-8	21707M	-8	21707M
-6	21708M	-6	21708M
-4	21709M	-4	21709M
-2	21710M	-2	21710M
-1	21711M	-1	21711M
-01	21712M	-01	21712M
-02	21713M	-02	21713M
-03	21714M	-03	21714M
-04	21715M	-04	21715M

Wire termination technical information

Cat. no. ABB distributor package	Cat. no. ABB bulk package	Cat. no. ABB distributor package	Cat. no. ABB bulk package	Cat. no. ABB distributor package	Cat. no. ABB bulk package	Cat. no. ABB distributor package	Cat. no. ABB bulk package
10RC-10	RC367	14RB-6FX	RB647-200	2A-18	AA2	18RAD-18277	RAD18277
10RC-10F	RC1157	14RB-6X	RB857-200	2A20	RAA24	18RAD-183	RAD1837
10RC-10FL	RC2227	14RB-8	RB867	2A22-20	A1A	18RAD-18377	RAD18377
10RC-10FLX	RC2227-250	14RB-8F	RB657	2B-14	BB2	2A-18	AA2
10RC-10FX	RC1157-250	14RB-8FL	RB2237	2B-16	RBB25	2A-18	AA2
10RC-10X	RC367-250	14RB-8FLX	RB2237-200	2B18-16	B1B	2A20	RAA24
10RC-14	RC717	14RB-8FX	RB657-200	2C-10	CC2-TB	2A22-20	A1A
10RC-14F	RC1167	14RB-8X	RB867-200	2C-12	RCC26	2B-14	BB2
10RC-14FL	RC2237	14RBC-10	RBC877	2C14-12	C1C	2B-16	RBB25
10RC-14X	RC717-250	14RBC-12	RBC757	2D10-9	D1D	2B18-16	B1B
10RC-250F	RC257	14RBC-14	RBC717	2D-8	DD102	2C-10	CC2-TB
10RC-250T	RC2517	14RBC-38	RBC797	2.00E-06	EE2	2C-12	RCC26
10RC-251T	RC25177	14RBC-516	RBC727	2E8-7	E1E	A18-250A	A252G
10RC-2577	RC2573	14RBC-6	RBC857	2F-4	FF2	A18-251T	A251
10RC-38	RC737	14RBD-182	RBD1827	2F6-5	F1F	A18-38	A73
10RC-38X	RC737-250	14RBD-18277	RBD18277	2G21	GG2	A18-516	A72
10RC-516	RC707	14RBD-183	RBD1837	2G4-2	G1G	A18-6	A85
10RC-55PT	RC55PT	14RBD-18377	RBD18377	2RA18	RAA21	A18-6F	A116
10RC-6	RC337	18RA-10	RA877	2RA18X	RAA217-170	A18-6FL	A221
10RC-6F	RC1337	18RA-10F	RA1157	2RAA	RAA23	A18-8	A86
10RC-6FL	RC2207	18RA-10FL	RA2257	2RAS18X	RAAS22X	A18-8F	A114
10RC-6FLX	RC2207-250	18RA-10FLX	RA2257-170	2RB14	RBB21	A18-8FL	A224
10RC-6X	RC337-250	18RA-10X	RA877-170	2RB14X	RBB217-200	AB14-10A	AB53
10RC-8	RC777	18RA-14	RA717	2RBB	RBB23	AB14-6A	AB51
10RC-8F	RC1147	18RA-250F	RA257	2RBS14X	RBBS22X	AB14-8A	AB52
10RC-8FL	RC2217	18RA-250T	RA2517	2RC10	RCC21	AD18-182	AD182
10RC-8FLX	RC2217-250	18RA-251T	RA25177	2RC10X	RCC217-250	AD18-183	AD183
10RC-8X	RC777-250	18RA-2577	RA2573	2RCC	RCC23	B14-10	B87
14RB-10	RB877	18RA-38	RA737	2RCS10X	RCCS22X	B14-10F	B115
14RB-10F	RB1157	18RA-4	RA77	2RD8	RDD27	B14-10FL	B225
14RB-10FL	RB2257	18RA-47PT	RA47PT	2RE6	REE28	B14-10G	B87G
14RB-10FLX	RB2257-200	18RA-516	RA727	2RZZ	RZZ23	B14-110F	B10TB
14RB-10FX	RB1157-200	18RA-516X	RA727-170	A18-10	A87	B14-111F	B11-TB
14RB-10X	RB877-200	18RA-6	RA857	A18-10F	A115-TB	B14-12	B75TB
14RB-14	RB717	18RA-6F	RA1167	A18-10FL	A225	B14-14	B71
14RB-14F	RB1717	18RA-6FL	RA2217	A18-110F	A10-TB	B14-250	B250
14RB-14X	RB717-200	18RA-6FLX	RA2217-170	A18-111F	A11	B14-250A	B252G
14RB-250F	RB257	18RA-6FX	RA1167-170	A18-12	A75	B14-250F	B250G
14RB-250T	RB2517	18RA-6X	RA857-170	A18-14	A71	B14-250T	B251G
14RB-251T	RB25177	18RA-8	RA867	A18-250	A250-TB	B14-251T	B251
14RB-2577	RB2573	18RA-8F	RA1147	18RA-6FLX	RA2217-170	B14-38	B73
14RB-38	RB737	18RA-8FL	RA2247	18RA-6FX	RA1167-170	B14-4	B132
14RB-4	RB1327	18RA-8FX	RA1147-170	18RA-6X	RA857-170	B14-516	B72
14RB-47PT	RB47PT	18RA-8X	RA867-170	18RA-8	RA867	B14-6	B133
14RB-516	RB727	18RAD-182	RAD1827	18RA-8F	RA1147	B14-6F	B64
14RB-6	RB857	18RAD-18277	RAD18277	18RA-8FL	RA2247	B14-6FL	B220
14RB-6F	RB647	18RAD-183	RAD1837	18RA-8FX	RA1147-170	B14-8	B86
14RB-6FL	RB2207	18RAD-18377	RAD18377	18RA-8X	RA867-170	B14-8F	B65TB
14RB-6FLX	RB2207-200	2A-18	AA2	18RAD-182	RAD1827	B14-8FL	B223

Note: All catalog numbers do not appear in this cross reference. This means it may not be available in one of the package options.

Wire termination technical information

Cat. no. ABB distributor package	Cat. no. ABB bulk package	Cat. no. ABB distributor package	Cat. no. ABB bulk package	Cat. no. ABB distributor package	Cat. no. ABB bulk package	Cat. no. ABB distributor package	Cat. no. ABB bulk package
B14-D	B23	E6-14	E71	RB4-HT	RB44-HT	RC10-10F	RC1153
BC14-10	BC87	E6-38	E73	RB14-10	RB873	RC10-10FL	RC2223
BC14-12	BC75	E6-516	E72	RB14-10F	RB1153	RC10-10FS	RC1253
BC14-14	BC71	F250TA	FTA250	RB14-10FL	RB2253	RC10-10X	RC364
BC14-38	BC79	F4-10	F26	RB14-10FS	RB1253	RC10-12	RC753
BC14-516	BC72	F4-12	F75	RB14-10X	RB874	RC10-14	RC713
BC14-6	BC85	F4-14	F71-TB	RB14-110F	RB10-SK	RC10-14F	RC1163
BC14-8	BC86	F4-38	F73	RB14-111F	RB11-TB	RC10-14FL	RC2233
BD14-183	BD183	F4-516	F72	RB14-12	RB753	RC10-14X	RC714
C10-10	C26	G2-12	G975	RB14-14	RB713	RC10-250A	RC2577F
C10-10A	C53	G2-14	G971	RB14-14F	RB1163	RC10-250F	RC250
C10-10F	C115	G2-38	G973	RB14-14X	RB714	RC10-38	RC733
C10-10FL	C222-TB	G2-516	G972	RB14-250	RBB250	RC10-38X	RC734
C10-12	C75	H10-14	H971	RB14-250A	RB2577F	RC10-516	RC703
C10-14	C71	J20-38	J973	RB14-250F	RB250	RC10-516X	RC704
BC14-10	BC87	K30-38	K973	RB14-250FP	RB250P	RC10-55PT	RC155PT
BC14-14	BC71	L40-38	L973	RB14-38	RB733	RC10-6	RC333
BC14-38	BC79	M250-38	M973	RB14-38X	RB734	RC10-6F	RC1113
BC14-516	BC72	NW14-10	NW83	RB14-4	RB1323	RC10-6FL	RC2203
BC14-6	BC85	NW14-12	NW84	RB14-47PT	RB147PT	RC10-6X	RC334
BC14-8	BC86	NW22-10	NW23	RB14-516	RB723	RC10-8	RC863
BD14-183	BD183	RA18-10	RA873	RB14-516X	RB724	RC10-8F	RC1123
C10-10	C26	RA18-10F	RA1153	RB14-6	RB853	RC10-8FL	RC2213
C10-10A	C53	RA18-10FL	RA2253	RB14-38	RB733	RC10-8FS	RC1223
C10-10F	C115	RA18-10FS	RA1253	RB14-38X	RB734	RC10-8X	RC864
C10-10FL	C222-TB	RA18-110F	RA10SK	RB14-4	RB1323	RC55	RC6
C10-12	C75	RA18-111F	RA11	RB14-47PT	RB147PT	RD8-10	RD367
C10-14	C71	RA18-12	RA753	RB14-516	RB723	RD8-12	RD757
C10-14F	C116-TB	RA18-14	RA713	RB14-516X	RB724	RD8-14	RD717
C10-250A	C252G	RA18-14F	RA1163	RB14-6	RB853	RD8-38	RD737
C10-250F	C250	RA18-250A	RA2577F	RB14-6F	RB1113	RD8-516	RD727
C10-38	C73	RA18-250F	RA250TB	RB14-6F	RB1113	RE6-10	RE267
C10-516	C70	RA18-250FP	RA250P	RB14-6FL	RB2213	RE6-12	RE757
C10-6F	C133	RA18-38	RA733	RB14-6FS	RB1203	RE6-14	RE717
C10-6FL	C220-TB	RA18-4	RA323	RB14-6X	RB854	RE6-38	RE737
C10-6-SK	C33	RA18-47PT	RA147PT	RB14-8	RB863	RE6-516	RE727
C10-8A	C52-TB	RA18-516	RA723	RB14-8F	RB1123	RF4-10	RF267
C10-8F	C114	RA18-6	RA853	RB14-8FL	RB2233	RF4-14	RF717
C10-8FL	C221	RA18-6F	RA1103	RB14-8FS	RB1223	RF4-38	RF737
C10-8-SK	C77	RA18-6FL	RA2213	RB14-8X	RB864	RF4-516	RF727
D8-10	D36	RA18-6FS	RA1203	RB14D	RB23	RG2-10	RG267
D8-12	D75	RA18-8	RA863	RB44	RB4-TB	RG2-12	RG757
D8-14-SK	D71	RA18-8F	RA1123	RBC14-12	RBC753	RG2-14	RG717
D8-38	D73	RA18-8FL	RA2243	RBC14-14	RBC713	RG2-38	RG737
D8-516	D72	RA18-8FS	RA1223	RBC14-8	RBC863	RG2-516	RG727
E6-10	E26	RA18D	RA23	RBD14-182	RBD1823	RP7-T	RP12-HT
E6-12	E75	RAD18-182	RAD1823	RBD14-183	RBD1833	RP12	RP7
E6-14	E71	RAD18-183	RAD1833	RC6-T	RC551-HT	A10-TB	A18-110F
E6-12	E75	RAD18-188A	RAD1887F	RC10-10	RC363	A11	A18-111F

Note: All catalog numbers do not appear in this cross reference. This means it may not be available in one of the package options.

Wire termination technical information

Cat. no. ABB distributor package	Cat. no. ABB bulk package	Cat. no. ABB distributor package	Cat. no. ABB bulk package	Cat. no. ABB distributor package	Cat. no. ABB bulk package	Cat. no. ABB distributor package	Cat. no. ABB bulk package
A114	A18-8F	BC71	BC14-14	FTA250	F250TA	RA753	RA18-12
A115-TB	A18-10F	BC72	BC14-516	G1G	2G4-2	RA77	18RA-4
A116	A18-6F	BC75	BC14-12	G971	G2-14	RA853	RA18-6
A1A	2A22-20	BC79	BC14-38	G972	G2-516	RA857	18RA-6
A221	A18-6FL	BC85	BC14-6	G973	G2-38	RA857-170	18RA-6X
A224	A18-8FL	BC86	BC14-8	G975	G2-12	RA863	RA18-8
A225	A18-10FL	BC87	BC14-10	GG2	2G21	RA867	18RA-8
A250-TB	A18-250	BD183	BD14-183	H971	H10-14	RA867-170	18RA-8X
A251	A18-251T	C114	C10-8F	J973	J20-38	RA873	RA18-10
A252G	A18-250A	C115	C10-10F	K973	K30-38	RA877	18RA-10
A71	A18-14	C116-TB	C10-14F	L973	L40-38	RA877-170	18RA-10X
A72	A18-516	C133	C10-6F	M973	M250-38	RAA21	2RA18
A73	A18-38	C1C	2C14-12	NW23	NW22-10	RAA217-170	2RA18X
A75	A18-12	C220-TB	C10-6FL	NW83	NW14-10	RAA23	2RAA
A85	A18-6	C221	C10-8FL	NW84	NW14-12	RAA24	2A20
A86	A18-8	C222-TB	C10-10FL	RA1153	RA18-10F	RAAS22X	2RAS18X
A87	A18-10	C250	C10-250F	RA1157	18RA-10F	RAD1823	RAD18-182
AA2	2A-18	C252G	C10-250A	RA1163	RA18-14F	RAD1827	18RAD-182
AB51	AB14-6A	C26	C10-10	RA1167	18RA-6F	RAD18277	18RAD-18277
AB52	AB14-8A	C33	C10-6-SK	RA1167-170	18RA-6FX	RAD1833	RAD18-183
AB53	AB14-10A	C52-TB	C10-8A	RA1203	RA18-6FS	RAD1837	18RAD-183
AD182	AD18-182	C53	C10-10A	RA1223	RA18-8FS	RA10SK	RA18-110F
AD183	AD18-183	C70	C10-516	RA1253	RA18-10FS	RA10SK	RA18-110F
B10TB	B14-110F	C71	C10-14	RA147PT	RA18-47PT	RA11	RA18-111F
B115	B14-10F	C73	C10-38	RA2213	RA18-6FL	RA1103	RA18-6F
B11-TB	B14-111F	C75	C10-12	RA2217	18RA-6FL	RA1123	RA18-8F
B132	B14-4	C77	C10-8-SK	RA2217-170	18RA-6FLX	RA1147	18RA-8F
B133	B14-6	CC2-TB	2C-10	RA2243	RA18-8FL	RA1147-170	18RA-8FX
B1B	2B18-16	D1D	2D10-9	RA2247	18RA-8FL	RAD18377	18RAD-18377
B220	B14-6FL	D36	D8-10	RA2253	RA18-10FL	RAD1887F	RAD18-188A
B223	B14-8FL	D71	D8-14-SK	RA2257	18RA-10FL	RB10-SK	RB14-110F
B225	B14-10FL	D72	D8-516	RA2257-170	18RA-10FLX	RB1113	RB14-6F
B23	B14-D	D73	D8-38	RA23	RA18D	RB1123	RB14-8F
B250	B14-250	D75	D8-12	RA250P	RA18-250FP	RB1153	RB14-10F
B250G	B14-250F	DD102	2D-8	RA250TB	RA18-250F	RB1157	14RB-10F
B251	B14-251T	E1E	2E8-7	RA2517	18RA-250T	RB1153	RB14-10F
B251G	B14-250T	E26	E6-10	RA25177	18RA-251T	RB1157	14RB-10F
B252G	B14-250A	E71	E6-14	RA257	18RA-250F	RB1157-200	14RB-10FX
B64	B14-6F	E72	E6-516	RA2573	18RA-2577	RB1163	RB14-14F
B65TB	B14-8F	E73	E6-38	RA2577F	RA18-250A	RB11-TB	RB14-111F
B71	B14-14	E75	E6-12	RA323	RA18-4	RB1203	RB14-6FS
B72	B14-516	EE2	2E-6	RA47PT	18RA-47PT	RB1223	RB14-8FS
B73	B14-38	F1F	2F6-5	RA713	RA18-14	RB1253	RB14-10FS
B75TB	B14-12	F26	F4-10	RA717	18RA-14	RB1323	RB14-4
B86	B14-8	F71-TB	F4-14	RA723	RA18-516	RB1327	14RB-4
B87	B14-10	F72	F4-516	RA727	18RA-516	RB147PT	RB14-47PT
B87	B14-10	F73	F4-38	RA727-170	18RA-516X	RB1717	14RB-14F
B87G	B14-10G	F75	F4-12	RA733	RA18-38	RB2207	14RB-6FL
BB2	2B-14	FF2	2F-4	RA737	18RA-38	RB2207-200	14RB-6FLX

Note: All catalog numbers do not appear in this cross reference. This means it may not be available in one of the package options.

Wire termination technical information

Cat. no. ABB distributor package	Cat. no. ABB bulk package	Cat. no. ABB distributor package	Cat. no. ABB bulk package	Cat. no. ABB distributor package	Cat. no. ABB bulk package
RB2213	RB14-6FL	RBBS22X	2RBS14X	RC364	RC10-10X
RB2233	RB14-8FL	RBC713	RBC14-14	RC367	10RC-10
RB2237	14RB-8FL	RBC717	14RBC-14	RC367-250	10RC-10X
RB2237-200	14RB-8FLX	RBC727	14RBC-516	RC55PT	10RC-55PT
RB2253	RB14-10FL	RBC757	14RBC-12	RC6	RC55
RB2257	14RB-10FL	RBC797	14RBC-38	RC703	RC10-516
RB2257-200	14RB-10FLX	RBC857	14RBC-6	RC704	RC10-516X
RB23	RB14D	RBC863	RBC14-8	RC707	10RC-516
RB250	RB14-250F	RBC877	14RBC-10	RC713	RC10-14
RB250P	RB14-250FP	RBD1823	RBD14-182	RC714	RC10-14X
RB2517	14RB-250T	RBD1827	14RBD-182	RC717	10RC-14
RB25177	14RB-251T	RBD18277	14RBD-18277	RC717-250	10RC-14X
RB257	14RB-250F	RBD1833	RBD14-183	RC733	RC10-38
RB2573	14RB-2577	RBD1837	14RBD-183	RC734	RC10-38X
RB2577F	RB14-250A	RBD18377	14RBD-18377	RC737	10RC-38
RB47PT	14RB-47PT	RC1113	RC10-6F	RC737-250	10RC-38X
RB4-TB	RB44	RC1123	RC10-8F	RC753	RC10-12
RB647	14RB-6F	RC1147	10RC-8F	RC777	10RC-8
RB647-200	14RB-6FX	RC1153	RC10-10F	RC777-250	10RC-8X
RB657	14RB-8F	RC1157	10RC-10F	RC863	RC10-8
RB657-200	14RB-8FX	RC1157-250	10RC-10FX	RC864	RC10-8X
RB713	RB14-14	RC1163	RC10-14F	RCC21	2RC10
RB714	RB14-14X	RC1167	10RC-14F	RCC217-250	2RC10X
RB717	14RB-14	RC1223	RC10-8FS	RCC23	2RCC
RB717-200	14RB-14X	RC1253	RC10-10FS	RCC26	2C-12
RB723	RB14-516	RC1337	10RC-6F	RCCS22X	2RCS10X
RB724	RB14-516X	RC155PT	RC10-55PT	RD367	RD8-10
RB727	14RB-516	RC2203	RC10-6FL	RD717	RD8-14
RB733	RB14-38	RC2207	10RC-6FL	RD727	RD8-516
RB734	RB14-38X	RC2207-250	10RC-6FLX	RD737	RD8-38
RB737	14RB-38	RC2213	RC10-8FL	RD757	RD8-12
RB753	RB14-12	RC2217	10RC-8FL	RDD27	2RD8
RB853	RB14-6	RC2217-250	10RC-8FLX	RE267	RE6-10
RB854	RB14-6X	RC2223	RC10-10FL	RE717	RE6-14
RB857	14RB-6	RC2227	10RC-10FL	RE727	RE6-516
RB857-200	14RB-6X	RC2227-250	10RC-10FLX	RE737	RE6-38
RB863	RB14-8	RC2233	RC10-14FL	RE757	RE6-12
RB864	RB14-8X	RC2237	10RC-14FL	REE28	2RE6
RB867	14RB-8	RC250	RC10-250F	RF267	RF4-10
RB867-200	14RB-8X	RC2517	10RC-250T	RF717	RF4-14
RB873	RB14-10	RC25177	10RC-251T	RF727	RF4-516
RB874	RB14-10X	RC257	10RC-250F	RF737	RF4-38
RB877	14RB-10	RC2573	10RC-2577	RG267	RG2-10
RB877-200	14RB-10X	RC2577F	RC10-250A	RG717	RG2-14
RBB21	2RB14	RC333	RC10-6	RG727	RG2-516
RBB217-200	2RB14X	RC334	RC10-6X	RG737	RG2-38
RBB23	2RBB	RC337	10RC-6	RG757	RG2-12
RBB25	2B-16	RC337-250	10RC-6X	RP7	RP12
RBB250	RB14-250	RC363	RC10-10		

Note: All catalog numbers do not appear in this cross reference. This means it may not be available in one of the package options.

Shrink-Kon® heat-shrinkable tubing

Protect against moisture, corrosion and abrasion!



ABB has you covered when it comes to insulation!

- Easy to use
- Heat shrinkable
- Products for heavy, medium and thin walls
- Covers available for H-type taps and splices

Shrink-Kon heavy-wall heat-shrinkable insulators

When it comes to moisture-proofing connections and terminations, ABB's heat-shrinkable tubing, boots and end caps have proven themselves over years of service to the industry. Made of thermally stabilized cross-linked polyolefin, these heat-shrinkable insulators can be used over lead, steel, aluminum, copper, standard plastic and elastomeric insulating materials.



ABB heat-shrinkable insulators are designed to be easy to use. They provide an appropriate level of insulation and abrasion protection.

Where applicable, ABB heat-shrink insulators are UL® listed. Also, all standard-size insulators have an internally applied adhesive sealant.

ABB heat-shrinkable insulators offer:

- Heavy-duty protection
- A full range of sizes from #14 to 2500 kcmil
- Field-proven reliability
- Internal sealant provides protection against moisture

Featured products include:

- High Shrink Ratio HSHR series with 6:1 shrink ratio designed for applications with extreme differences between cable, connector and back shell sizes
- Flame Retardant HSMR series provides maximum flame retardancy

Shrink-Kon heavy-wall heat-shrinkable end cap and boots

Redesigned for superior durability and performance!

Seals and insulates cable ends at a 600 V rating. Installs fast, while providing insulation resistance to moisture, corrosion and abrasion. The extra thickness at the tip of the end cap prevents sharp ends of the cable from puncturing the seal.

Seals and insulates multiconductor cables and conduit with the same cost savings and superior properties of ABB's heat-shrinkable tubing. These boots replace time-consuming tapes, epoxies, encapsulations and dips. The boots are internally coated with sealant.

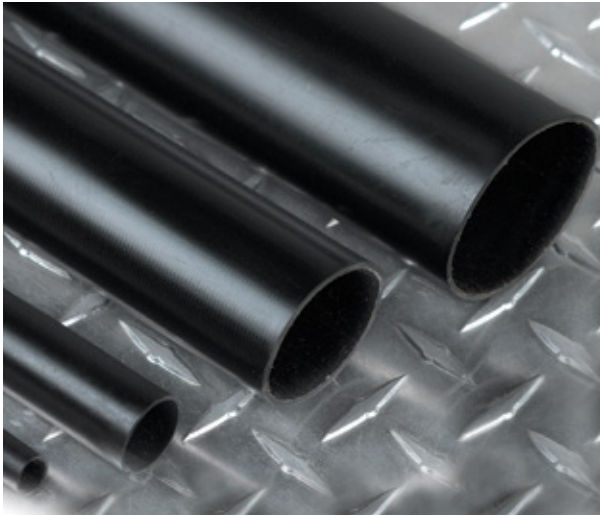

Shrink-Kon medium wall tubing

More flexible than heavy-wall products, with excellent resistance to impact and abrasion.

- Seals and protects cable splices and terminations
- Thermoplastic adhesive liner guarantees complete environmental protection and insulation

Shrink-Kon thin wall tubing

Manufactured from stabilized Polyolefin, these insulators are used to insulate bare Sta-Kon® and Blackburn® connectors and splices. They also provide a degree of strain relief and may be used to harness wires. Available in cut pieces or reels.

Featured products include:

- Standard non-lined 2:1 thin wall tubing
- 3:1 adhesive-lined thin wall CPO-A series provides excellent flexibility with environmental sealing capability
- Extra-clear heat shrink for use on power connections and data connections

Covers

These new insulating covers provide hard-shell insulated protection for “H” type compression taps and splices, and, because there is no taping required, you get uniform quality and appearance each time. The exclusive locking design provides the range-taking capability. Only six H-tap insulating catalog numbers accommodate the range of #6 AWG – 1000 kcmil in the main and #12 AWG – 500 kcmil in the branch.

- Hard-shell outer covers guard against impact, inner seal keeps out dust
- Installs quickly and easily without special tools – Simply snap together
- Eliminates time-consuming taping
- Provides high-quality, neat, uniform installations
- Range-taking design reduces inventory



Shrink-Kon® heat-shrinkable tubing

HS series



3:1 Shrink ratio

- Made of thermally stabilized cross-linked polyolefin, enabling a recovered wall thickness greater than the cable jacket replaced
- Withstands severe mechanical requirements of U.R.D., submersible, and direct-burial installations
- Tubing, featuring an internally applied sealant, offers protection against moisture, and may be used over lead, steel, aluminum, copper, standard plastic and elastomeric insulating materials
- Shrink temperature of 120 °C
- High impact, abrasion, corrosion and chemical resistance
- Rated for 600 V, 90 °C continuous use. Maximum rating 1 kV at 90 °C
- Thermoplastic adhesive liner provides complete environmental protection and insulation
- Meets: UL® 486D, CSA C22.2 No. 198.2, ANSI C119.1, Western Underground Guide Numbers 2.4, 2.5, ICEA and NEMA insulation thickness requirements
- Continuous operating temperature: -55 °C to 110 °C

HS series specifications

Property	Test method	Typical performances
Physical		
Tensile strength	ASTM D412, ISO 37	2100 psi (14.5MPa)
Elongation	ASTM D412, ISO 37	600%
Elongation after heat aging (168 hrs. at 150 °C)	ASTM D2671	500%
Heat shock (4 hrs. at 225 °C)	ASTM D2671	No cracking or flowing
Longitudinal change	ASTM D2671	+1%, -10%
Low temperature flexibility (4 hrs. at -55 °C)	ASTM D2671	No cracking
Specific gravity	ASTM D792	1.1
Hardness (Shore D)	ASTM D2240	50D
Electrical		
Dielectric strength	ASTM D149	500 V/Mil (20k V/mm)
Dielectric voltage withstand	UL 486D	No Breakdown, (2500 V, 60 Hz, 1 min.)
Volume resistivity	ASTM D257	1016 ohm-cm



Property	Test method	Typical performances
Chemical		
Fluid resistance	MIL-DTL-23053	Good to excellent
Fungus resistance	ASTM G21	No growth
Copper corrosion	ASTM D2671	No corrosion
Water absorption	ASTM D570	0.1%
Adhesive		
Adhesive lap shear (1 in./min. at 23 °C)	ASTM D1002	125 psi (.875 MPa)
Adhesive softening point	ASTM E28	92 °C ±5 °C
Adhesive peel strength (300 mm/min. At 23 °C) – To steel, aluminum, P.E. – PVC	ASTM D1000	35 pli 20 pli
Water penetration	STM 706	No penetration after 236 hrs. of continuous immersion

Shrink-Kon® heat-shrinkable tubing

HS series – Heavy wall tubing

HS series heavy-wall heat-shrinkable tubing – Black

Cat. no.	Dimensions (in.)				Fits any listed or certified Al or Cu splice with dim no larger than		Std. cable range (AWG or kcmil)	Pkg. qty.
	Min. expanded I.D.	Max. recovered I.D.	Nom. recovered wall	Std. length	O.D. (in.)	Length (in.)		
 HS16-12	0.35	0.12	0.07	3	0.27	1.00	#16 to #12	25
HS16-12L	0.35	0.12	0.07	6	0.27	1.00	#16 to #12	25
HS16-12-4	0.35	0.12	0.07	48	0.27	1.00	#16 to #12	5
HS12-6	0.51	0.16	0.09	3	0.38	1.75	#12 to #6	25
HS12-6L	0.51	0.16	0.09	6	0.38	1.75	#12 to #6	25
HS12-6-4	0.51	0.16	0.09	48	0.38	1.75	#12 to #6	5
HS6-1	0.75	0.24	0.09	4	0.63	2.50	#6 to #1	25
HS6-1L	0.75	0.24	0.09	8	0.63	2.50	#6 to #1	25
HS6-1-4	0.75	0.24	0.09	48	0.63	2.50	#6 to #1	5
HS4-30	1.10	0.35	0.12	5	0.75	3.25	#4 to 3/0	20
HS4-30L	1.10	0.35	0.12	9	0.75	3.25	#4 to 3/0	10
HS4-30-4	1.10	0.35	0.12	48	0.75	3.25	#4 to 3/0	5
HS40-400	1.50	0.47	0.16	8	–	–	4/0 to 400	10
HS40-400L	1.50	0.47	0.16	12	–	–	4/0 to 400	10
HS40-400-4	1.50	0.47	0.16	48	–	–	4/0 to 400	5
HS500-1000	2.00	0.63	0.16	9	–	–	500–1000	5
HS500-1000L	2.00	0.63	0.16	15	–	–	500–1000	2
HS500-1000-4	2.00	0.63	0.16	48	–	–	500–1000	2
HS12-30*	3.54	1.18	0.16	12	–	–	800–1250	2
HS30-30*	3.54	1.18	0.16	30	–	–	800–1250	2
HS30-4*	3.54	1.18	0.16	48	–	–	800–1250	1
HS12-40*	4.72	1.57	0.17	12	–	–	1500–2500	1
HS30-40*	4.72	1.57	0.17	30	–	–	1500–2500	1
HS40-4-TB*	4.72	1.57	0.17	48	–	–	1500–2500	1

Order multiple is std. pkg. All lengths have factory-applied sealant. UL* file no. E9809, UL 486D. * Not UL listed.

HS series heavy-wall heat-shrinkable tubing – Red

Cat. no.	Dimensions (in.)			Length	For 2-way connector cable sizes (AWG)	Std. pkg. qty.
	Min. expanded I.D.	Max. recovered I.D.	Nominal recovered wall			
 HS12-6LR	0.51	0.16	0.09	6	#8–#6	25
HS6-1LR	0.75	0.24	0.09	8	#6–#2	25
HS4-30LR	1.10	0.35	0.12	9	#1–3/0	10

Order multiple is std. pkg. All lengths have factory-applied sealant. UL File No. E9809, UL 486D

Heavy-wall tubing (25' rolls) – Black

Cat. no.	Dimensions (in.)			Code cable size (AWG or kcmil)	Std. pkg. (rolls)
	Min. expanded I.D.	Max. recovered I.D.	Nominal recovered wall		
 HS16-12-25	0.35	0.12	0.07	#14–#10	1
HS12-6-25	0.51	0.16	0.09	#8–#6	1
HS6-1-25	0.75	0.24	0.09	#6–#2	1
HS4-30-25	1.10	0.35	0.12	#1–3/0	1
HS40-400-25	1.50	0.47	0.16	2/0–350	1
HS500-1000-25	2.00	0.63	0.16	250–500	1

Order by reel, not by feet. 25' reels not supplied with factory-applied sealant. Not UL Listed.

Shrink-Kon® heat-shrinkable tubing

HSHR series – High shrink ratio

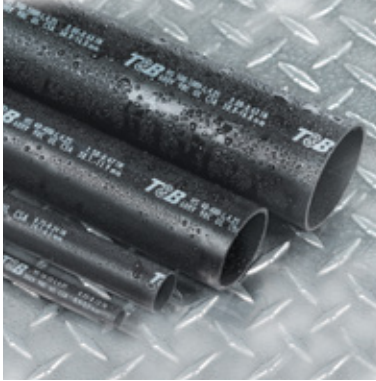

6:1 Shrink ratio

- Accommodates a wide variety of connector shapes and configurations
- Thermoplastic adhesive liner for complete environmental protection and insulation
- Continuous operating temperature: -55 °C to 110 °C
- Shrink temperature: 120 °C
- Flame retardant: UL94 – V0

HSHR series heavy-wall heat-shrinkable tubing

Cat. no.	Dimensions (in.)			Code cable size (AWG or kcmil)	Standard length (in.)	Std. pkg. qty.
	Min. expanded I.D.	Max. recovered I.D.	Nominal recovered walled			
HSHR750-4	0.75	0.13	0.10	#22-#46	48	25
HSHR1300-4	1.30	0.22	0.12	#8-700	48	25
HSHR1750-4	1.75	0.29	0.13	#4-1000	48	25
HSHR2000-4	2.00	0.33	0.13	#2-1250	48	25
HSHR2750-4	2.75	0.46	0.14	1/0-1500	48	15
HSHR3500-4	3.50	0.58	0.15	3/0-1750	48	10
HSHR4700-4	4.70	0.78	0.15	300-2000	48	5

Order multiple is std. pkg. Standard color: black.

HSHR series specifications

Property	Test method	Typical performance
Physical		
Tensile strength	ASTM D412, ISO 37	2100 psi (14.5MPa)
Elongation	ASTM D412, ISO 37	600%
Elongation after heat aging (168 hrs. at 175 °C)	ASTM D2671	500%
Heat shock (4 hrs. at 225 °C)	ASTM D2671	No cracking or flowing
Longitudinal change	ASTM D2671	+1%, -10%
Low-temperature flexibility (4 hrs. at -55 °C)	ASTM D2671	No cracking
Specific gravity	ASTM D792	1.10
Hardness (Shore D)	ASTM D2240	50D
Electrical		
Dielectric strength	ASTM D149, IEC 243	500 V/mil (20 kV/mm)
Dielectric voltage withstand	UL 486D	No breakdown
Volume resistivity	ASTM D257	1016 ohm-cm

Property	Test method	Typical performance
Chemical		
Fluid resistance	MIL-DTL-23053/15	Good to excellent
Fungus resistance	ASTM G21	No growth
Copper corrosion	ASTM D2671	No corrosion
Water absorption	ASTM D570	0.1%
Adhesive		
Adhesive lap shear (1 In./min. at 23 °C)	ASTM D1002	125 psi (.875 MPa)
Adhesive softening point	ASTM E28	92 °C/-5 °C
Adhesive peel strength (300mm/min. at 23 °C) – to steel, aluminum, P.E. – PVC	ASTM D1000	35 pli 20 pli
Adhesive blocking (30 °C)	ASTM D1146	No blocking
Water penetration	STM 706	No penetration after 236 hrs. of continuous immersion

Shrink-Kon® heat-shrinkable tubing

HSFR series – Flame-retardant heavy wall



3:1 Shrink ratio

- Insulates and protects electrical splices and terminations
- High impact and abrasion resistance
- Thermoplastic adhesive liner
- Rated for 600 V, 90 °C continuous use. Continuous operating temperature: -55 °C to 110 °C
- Shrink temperature of 120 °C
- Meets: UL® 486D, CSA 22.2 No. 198.2, ANSI C119.1, Western Underground Guide Nos. 2.4, 2.5, MIL-DTL-23053/15, IEEE 383 Vertical Flame Test, ANSI C37.20.2, ICEA S-19-8 and NEMA insulation thickness requirements

HSFR series heavy-wall heat-shrinkable tubing

Cat. no.	Dimensions (in.)			Code cable size (AWG or kcmil)	Standard length (in.)	Std. pkg. qty.
	Min. expanded I.D.	Max. recovered I.D.	Nominal recovered walled			
HSFR16-12-4	0.35	0.12	0.07	#14-#10	48	25
HSFR12-6-4	0.51	0.16	0.09	#8-#6	48	25
HSFR6-1-4	0.75	0.24	0.09	#6-#2	48	25
HSFR4-30-4	1.10	0.35	0.12	#1-3/0	48	25
HSFR40-400-4	1.50	0.47	0.16	2/0-350	48	25
HSFR500-1000-4	2.00	0.63	0.16	250-500	48	25

Custom lengths available, subject to factory quotations. Minimum quantities may apply.

HSFR series specifications

Property	Test method	Typical performance
Physical		
Tensile strength	ASTM D412, ISO 37	2100 psi (14.5MPa)
Elongation	ASTM D412, ISO 37	600%
Longitudinal change	ASTM D2671	+1%, -10%
Specific gravity	ASTM D792	1.2
Elongation after heat aging (168 hrs. at 175 °C)	ASTM D2671, ISO 37	500%
Heat shock (4 hrs. at 225 °C)	ASTM D2671	No cracking or flowing
Low temperature flexibility (4 hrs. at -55 °C)	ASTM D2671	No cracking or splitting
Hardness (Shore D)	ASTM D2240	50D
Oxygen index	ASTM D2863	27.00
Flammability	ASTM D2671	Flame retardant
Electrical		
Dielectric strength	ASTM D149	500 V/mil (20 kV/mm)
Dielectric voltage withstand (2500 V, 60 Hz, 1 Min.)	UL 486D	No breakdown 24 kV – 1 min., 15 kV – 4 hrs
Volume resistivity	ASTM D257	1016 ohm-cm

Property	Test method	Typical performance
Chemical		
Fluid resistance	MIL-DTL-23053/5	Good to excellent
Copper corrosion	ASTM D2671	No corrosion
Fungus resistance	ASTM G21	No growth
Water absorption	ASTM D570	0.2%
Adhesive		
Adhesive lap shear (1 in./min. at 23 °C)	ASTM D1002	125 psi (.875 MPa)
Adhesive softening point	ASTM E28	92 °C ±5 °C
Adhesive peel strength (300 mm/min. at 23 °C) – to steel, aluminum, P.E. – PVC	ASTM D1000	35 pli 20 pli
Adhesive blocking (30 °C)	ASTM D1146	No blocking
Adhesive water absorption	ASTM D570	Less than 0.3%
Water penetration	STM 706	No penetration after 286 hrs. of continuous immersion

Shrink-Kon® heat-shrinkable tubing

HSC series end caps



3:1 Shrink ratio

- Provides effective method for sealing cable ends, pipe conduit, etc.
- Extra thickness at the tip of the end cap prevents sharp ends of the cable from puncturing the seal
- Flame retardant
- Rated from 600/1000 V, 90° continuous use
- Shrink temperature of 120 °C
- Resistant to common fluids and solvents
- Adhesive liner provides complete environmental protection and insulation
- Heat indicating lines. Continuous operating temperature: -55 °C to 110 °C

HSC series heat-shrinkable end caps

Cat. no.	Dimensions (in.)		Recovered walled	Code cable size (AWG or kcmil)	Standard length (in.)	Std. pkg. qty.
	Min. expanded I.D.	Max. recovered I.D.				
HSC8-4	0.51	0.16	0.09	#8-#6	2.50	10
HSC2-20	0.75	0.24	0.09	#6-#2	2.50	10
HSC30-250	1.10	0.35	0.12	#1-3/0	3.00	5
HSC300-600	1.50	0.47	0.16	2/0-350	3.50	5
HSC700-1000	2.00	0.63	0.16	250-500	3.50	5
HSC750	2.70	0.87	0.16	600-1000	4.00	10
HSC300*	3.50	1.18	0.16	800-1250	4.50	5
HSC500*	4.70	1.57	0.17	1500-2500	5.50	5

Order multiple is std. pkg. *Not UL® listed or CSA certified.

HSC series specifications

Property	Test method	Typical performance
Physical		
Tensile strength	ASTM D412, ISO 37	2100 psi (14.5MPa)
Elongation	ASTM D412, ISO 37	550%
Elongation after heat aging (168 hrs. at 150 °C)	ASTM D2671	500%
Heat shock (4 hrs. at 225 °C)	ASTM D2671	No cracking or flowing
Longitudinal change on recovery	ASTM D2671	+1%, -10% on Recovery
Low-temperature flexibility (4 hrs. at -55 °C)	ASTM D2671	No cracking
Specific gravity	ASTM D792	1.10
Hardness (Shore D)	ASTM D2240	50D
Electrical		
Dielectric strength	ASTM D149	500 V/mil (20 kV/mm)
Dielectric voltage withstand	UL 486D	No breakdown (2500 V, 60 Hz, 1 min.)
Volume resistivity	ASTM D257	1016 ohm-cm

Property	Test method	Typical performance
Chemical		
Fluid resistance	MIL-DTL-23053	Good to excellent
Fungus resistance	ASTM G21	No growth
Copper corrosion	ASTM D2671	No corrosion
Water absorption	ASTM D570	0.1%
Seal integrity		
Adhesive lap shear (1 in./min. at 23 °C)	ASTM D1002	130 psi (0.91 MPa)
Adhesive softening point	ASTM E28	92 °C ±5 °C
Adhesive peel strength (300 mm/min. at 23 °C) - to steel, aluminum, P.E. - PVC	ASTM D1000 (mod.)	35 pli 20 pli
Adhesive blocking (30 °C)	ASTM D1146	No blocking
Water penetration	STM 706	No penetration after 236 hrs. of continuous immersion
Room temperature	168 hrs./40 psi	No leaks
Temp. cycling (-40 °C to 60 °C)	50 cycles/15 psi	No leaks
Burst pressure		100 psi (0.70 MPa)



Shrink-Kon® heat-shrinkable tubing

HSB series – Heat-shrinkable breakout boots



- Boots for 2-, 3- and 4-way cable breakouts
- Thermoplastic adhesive liner provides complete environmental protection and insulation
- Meets ESI 09-11
- Strain relief and mechanical protection
- Continuous operating temperature: -55 °C to 100 °C
- Shrink temperature of 135 °C

HSB series heat-shrinkable breakout boots

Cat. no.	No. legs	D (in.)		Expanded dia. (max.)	Recovered dia. (max.)	L (in.)		TB (in.)		TL (in.)		Application legs 600 V conductor (AWG/kcmil)	Std. pkg. qty.
		Min. expanded I.D.	Max. recovered I.D.			Recovered length (nom.)	Wall thickness of body (nom.)	Wall thickness of leg (nom.)	TL (nom.)				
HSB200-75-2	2	1.97	0.83	0.90	0.20	4.69	0.13	0.13	#3-300	10			
HSB120-50-3	3	1.50	0.65	0.50	0.16	4.47	0.11	0.11	#8-3/0	10			
HSB170-82-3	3	2.20	1.20	0.89	0.35	7.09	0.12	0.12	#1-600	10			
HSB240-112-3	3	2.83	1.46	1.38	0.69	7.01	0.16	0.12	300-1000	10			
HSB125-50-4	4	1.38	0.59	0.47	0.12	3.74	0.10	0.08	#12-2/0	10			
HSB175-82-4	4	2.36	1.18	0.90	0.25	7.95	0.16	0.13	#4-600	10			
HSB265-120-4	4	3.10	1.50	1.40	0.49	9.45	0.13	0.13	3/0-1000	10			
HSB350-138-3	3	3.54	1.38	1.34	0.55	7.87	0.12	0.08	4/0-1000	5			
HSB430-157-3	3	4.33	1.57	1.38	0.69	7.01	0.16	0.12	300-1000	5			
HSB490-200-3	3	4.92	2.00	2.32	1.00	11.14	0.15	0.15	750-1000	5			
HSB520-135-4	4	5.25	1.35	3.00	0.55	10.02	0.13	0.16	4/0-1000	5			

Order multiple is std. pkg.

Heat-shrinkable breakout boots specifications

Property	Test method	Typical performance
Physical		
Tensile strength	ASTM D412, IEC 540	2120 psi (14.6 MPa)
Ultimate elongation	ASTM D412, IEC 540	600%
Elongation after heat aging (168 hrs. at 175 °C)	ASTM D412, IEC 540	520%
Heat shock (4 hrs. at 225 °C)	ASTM D2671	No dripping, cracking, flowing
Low-temperature flexibility (-55 °C)	ASTM D2671	No cracking
Flammability	ASTM D630	Self ext. within 1.97"

Property	Test method	Typical performance
Electrical		
Dielectric strength	ASTM D2671	280 V/Mil (11 kV/mm)
Chemical		
Water absorption	ASTM D570	0.03%

Diagrams

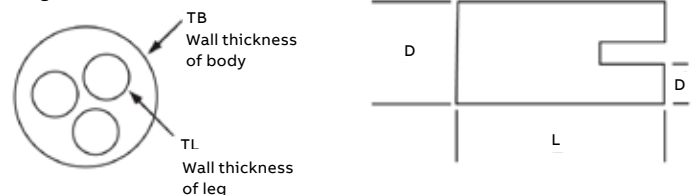

Shrink-Kon® heat-shrinkable tubing

HSMW series – Medium-wall tubing

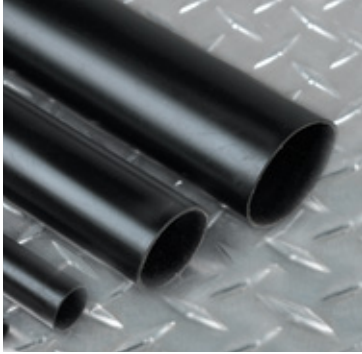

HSMW series medium-wall heat-shrinkable tubing

3:1 Shrink ratio

- More flexible than heavy-wall products
- Seals and protects cable splices and terminations
- High resistance to impact and abrasion
- Shrink temperature of 120 °C
- Continuous operating temperature: -55 °C to 110 °C
- Thermoplastic adhesive liner guarantees complete environmental protection and insulation

Cat. no.	Dimensions (in.)			Code cable size (AWG or kcmil)	Standard length (in.)	Std. pkg. qty.
	Min. expanded I.D.	Max. recovered I.D.	Nominal recovered walled			
HSMW400-48	0.40	0.15	0.080	#4-#14	48	25
HSMW750-48	0.75	0.22	0.080	4/0-#8	48	25
HSMW1100-48	1.10	0.40	0.095	400-#1	48	25
HSMW1300-48	1.30	0.40	0.095	600-#1	48	25
HSMW1500-48	1.50	0.50	0.095	750-3/0	48	25
HSMW1700-48	1.70	0.50	0.100	1000-2/0	48	25
HSMW2050-48	2.05	0.75	0.100	250-600	48	25
HSMW2750-48	2.75	1.00	0.100	500-1000	48	15
HSMW3500-48	3.50	1.18	0.100	750-1250	48	10
HSMW4700-48	4.70	1.57	0.110	1500-2500	48	5
HSMW6700-48	6.70	2.30	0.120	-	48	5
HSMW9000-48	9.00	3.00	0.130	-	48	5

Order multiple is std. pkg.

HSMW series specifications

Property	Test method	Typical performance
Physical		
Tensile strength	ASTM D412, ISO 37	2100 psi (14.5MPa)
Elongation	ASTM D412, ISO 37	550%
Longitudinal change	ASTM D2671	+1%, -10%
Specific gravity	ASTM D792, ISO/R1183	1.1
Elongation after heat aging (168 hrs. at 150 °C)	ASTM D2671, ISO 37	500%
Heat shock (4 hrs. at 225 °C)	ASTM D2671	No cracking or flowing
Low-temperature flexibility (4 hrs. at -55 °C)	ASTM D2671	No Cracking
Hardness (Shore D)	ASTM D2240	50D
Electrical		
Dielectric strength	ASTM D149, IEC 243	500 V/mil (20 kV/mm)
Dielectric voltage withstand (2500 V, 60 Hz, 1 min.)	UL 486D	No breakdown
Volume resistivity	ASTM D257	10 ¹⁶ ohm-cm

Property	Test method	Typical performance
Chemical		
Fluid resistance	MIL-DTL-23053/5, ISO 1817, ISO 37	Good to excellent
Copper corrosion	ASTM D2671	No corrosion
Fungus resistance	ASTM G21	No growth
Water absorption	ASTM D570	0.1%
Adhesive		
Adhesive lap shear (1 in./min. at 23 °C)	ASTM D1002 (mod)	125 psi (0.875 MPa)
Adhesive softening point	ASTM E28	92 °C/-5 °C
Adhesive peel strength (300 mm/min. at 23 °C)	ASTM D1000	35 pli 20 pli
— to steel, aluminum, P.E. — PVC		
Adhesive blocking (30 °C)	ASTM D1146	No blocking
Water penetration	STM 706	No penetration after 286 hrs. of continuous immersion

Shrink-Kon® heat-shrinkable tubing

CPO series – Thin-wall tubing, non-lined



2:1 Shrink ratio

- Flame-retardant, cross-linked polyolefin
- Continuous operating temperature: -55 °C to 135 °C
- Shrink temperature of 120 °C

- Meets UL® 224, 125 °C; CSA C22.2 No. 198.1, 125 °C; MIL-DTL-23053/5 Class 1&2; AMS 3636 & 3637; DEF STAN 59-97, Issue 3, Type 2a

CPO series thin-wall heat-shrinkable tubing



Cat. no.	Dimensions (in.)			Code cable size (AWG or kcmil)
	Min. expanded I.D.	Max. recovered I.D.	Nom. recovered walled	
CPO63-_-	0.06	0.03	0.02	-
CPO93-_-	0.09	0.05	0.02	-
CPO125-_-	0.13	0.06	0.02	#24-#30
CPO187-_-	0.19	0.09	0.02	#14-#22
CPO250-_-	0.25	0.13	0.03	#10-#16
CPO375-_-	0.38	0.19	0.03	#6-#12
CPO500-_-	0.50	0.25	0.03	#1-#6
CPO750-_-	0.75	0.38	0.03	4/0-#2
CPO1000-_-	1.00	0.50	0.04	350-2/0

See catalog construction to complete.

UL recognized file number E137759 and CSA certified. (Note: Clear material not UL recognized.)

When ordering standard package, order by package not feet.

Larger diameters available upon special request; consult technical services.

Order multiple for 4' sticks is 25 sticks.

Order multiple for reels is 1 reel.

Catalog number construction

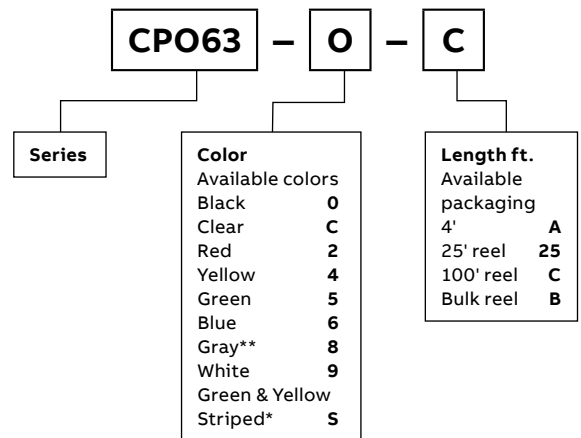

* Contact customer service for bulk reel quantity.

** Minimum order required.

Thin-wall heat-shrinkable tubing kit

Cat. no.	Description	Std. pkg.
HS-KIT	Assortment of six different sizes (from 3/16" to 1") of black thin-wall heat-shrinkable tubing pre-cut to 6" lengths. Exceptional value; also includes handy plastic storage case.	1
CHS-KIT	Assortment of six different sizes (from 3/16" to 1") of multi-colored thin-wall heat-shrinkable tubing pre-cut to 6" lengths. Exceptional value; also includes handy plastic storage case.	1

Order multiple is std. pkg.

Thin-wall heat-shrinkable tubing – 6" lengths

Cat. no.	Dimensions (in.)			Std. pkg. qty.
	Minimum expanded I.D.	Maximum reduced I.D.	Nom. recovered wall thickness	
CPO63-0-6	0.06	0.03	0.02	20
CPO93-0-6	0.09	0.05	0.02	20
CPO125-0-6	0.13	0.06	0.02	20
CPO187-0-6	0.19	0.09	0.02	20
CPO250-0-6	0.25	0.13	0.03	20
CPO375-0-6	0.38	0.19	0.03	20
CPO500-0-6	0.50	0.25	0.03	10
CPO750-0-6	0.75	0.38	0.03	10
CPO1000-0-6	1.00	0.50	0.04	5

Order multiple is std. pkg. Catalog numbers listed are black color; other colors available upon request.

Shrink-Kon® heat-shrinkable tubing

Custom-cut length of bulk packaging – Thin-wall tubing



2:1 Shrink ratio

Custom order lengths for those special jobs!

To best meet your requirements for thin-wall heat-shrinkable tubing, ABB welcomes the opportunity to cut bulk reels of tubing. Minimum order requirement is one standard bulk reel, and multiples thereof. See table for bulk reel length by size. Tubing cannot be cut smaller than ½".

When ordering custom-cut lengths of tubing, order by piece, not by length. To determine the minimum number of pieces to order, simply figure how many pieces of a specific length of tubing are required to make use of a complete bulk reel. See examples to convert bulk reels to cut pieces.

Example 1

If a bulk length of tubing is 1,000' and the desired length of each individual piece is 6", the minimum order requirement is 2,000 pieces.

Given (length of reel).....1,000'
 Convert to inches
 by multiplying by 12.....12 x 1,000
 Length of reel in inches.....= 12,000
 Divide by desired length.....12,000 ÷ 6
 Total number of 6" pieces
 in a 1,000' reel (minimum order).....= 2,000

Example 2

If a bulk reel of tubing is 400' and the desired length of each individual piece is 2", the minimum order requirement is 2,400 pieces.

Given (length of reel).....400'
 Convert to inches by multiplying by 12...12 x 400
 Length of reel in inches= 4,800
 Divide by desired length.....4,800 ÷ 2
 Total number of 2" pieces
 in a 400' reel (minimum order).....= 2,400

2:1 Shrink ratio



Series	Bulk reel length (ft.)	Series	Bulk reel length (ft.)
CPO63 = ¼"	1,000	CPO375 = ¾"	500
CPO93 = ⅜"	1,000	CPO500 = 1"	400
CPO125 = ½"	1,000	CPO750 = ¾"	300
CPO187 = ⅝"	1,000	CPO1000 = 1"	300
CPO250 = ¾"	1,000	-	-

Minimum order quantity for cut pieces.

Contact tech. services for pricing and availability on cut pieces.

Thin-wall tubing specifications

Property	Test method	Typical performance
Physical		
Tensile strength	ASTM D2671, ISO 37	2,200 psi (15.0 MPa)
Elongation	ASTM D2671, ISO 37	400%
Longitudinal change	ASTM D2671	+1%, -10%
2% Secan modulus	ASTM D2671	16,000 psi (110 MPa)
Specific gravity	ASTM D792, ISO/R1183	1.3" (colors) 0.95" (clear)
Restricted shrinkage	ASTM D2671	No cracking
Elongation after heat aging (168 hrs. at 175 °C)	ASTM D2671	350%
Heat shock (4 hrs. at 250 °C)	ASTM D2671	No cracking or flowing
Low-temperature flexibility (4 hrs. at -55 °C)	ASTM D2671	No cracking or splitting
Flammability	ASTM D2671	Flame retardant (except clear)
Electrical		
Dielectric strength	ASTM D2671, IEC 243	600 V/mil (24 kV/mm)
Volume resistivity	ASTM D2671	1016 O HM-CM
Chemical		
Fluid resistance	MIL-DTL-23053/5, ISO 1817, ISO 37	Good to excellent
Copper corrosion	ASTM D2671	No corrosion
Water absorption	ASTM D570	0.2%
Fungus resistance	ASTM G21	No growth

Cut piece catalog no. construction

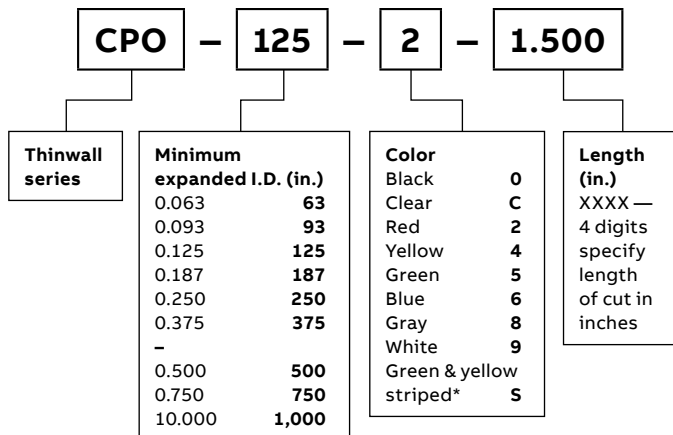

Example: CPO + 125 + 2 + 1.500 = CPO125-2-1.500 CPO thinwall shrink, size 125 (0.125"), red color, 1.5" long

*Contact customer service for bulk reel quantity.

Shrink-Kon® heat-shrinkable tubing

CPO-A series – Thin-wall, adhesive lined

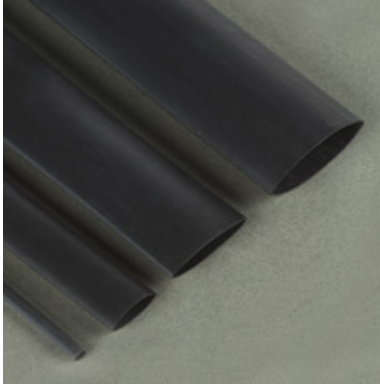

3:1 Shrink ratio

- Adhesive lined for moisture-proof environmental seal
- High 3:1 shrink ratio for covering irregularly shaped objects
- Continuous operating temperature -55 °C to 110 °C
- Shrink temperature 120 °C

CPO-A series thin-wall heat-shrinkable tubing

Cat. no.	Dimensions (in.)			Code cable size (AWG)	Standard length (in.)	Std. pkg. qty.
	Min. expanded I.D.	Max. recovered I.D.	Nominal recovered walled			
CPO-A-125-48	0.13	0.02	0.04	#24-#30	48	25
CPO-A-187-48	0.18	0.06	0.05	#14-#22	48	25
CPO-A-250-48	0.25	0.08	0.05	#10-#22	48	25
CPO-A-375-48	0.38	0.14	0.05	#6-#16	48	25
CPO-A-500-48	0.50	0.19	0.07	#2-#12	48	25
CPO-A-750-48	0.75	0.31	0.07	3/0-#4	48	25

Note: Non-standard colors, sizes and lengths available subject to factory quotation. Standard color: Black

CPO-A series specifications

Property	Test method	Typical performance
Physical		
Tensile strength	ASTM D2671, ISO 37	2200 psi (15.0 MPa)
Elongation	ASTM D2671, ISO 37	400%
Heat shock (4 hrs. at 250 °C)	ASTM D2671	No cracking or flowing
Longitudinal change	ASTM D2671	±5%
Low-temperature flexibility (4 hrs. at -55 °C)	ASTM D2671	No cracking
Specific gravity	ASTM D792, ISO R1183	1.1
2% Secant modulus	ASTM 2671	1600 psi (110 MPa)
Heat-resistant properties (168 hrs. at 175 °C)	MIL-DTL-23053/4	240%
Flammability	ASTM D2671	Moderately flame retardant

Property	Test method	Typical performance
Electrical		
Dielectric strength	ASTM D2671, IEC 243	600 V/mil (24 kV/mm)
Volume resistivity	ASTM D2671	1016 ohm-cm
Chemical		
Fluid resistance	MIL-DTL-23053/4, ISO 1817, ISO 37	Good to excellent
Fungus resistance	ASTM G21	No growth
Copper corrosion	ASTM D2671	No corrosion
Water absorption	ASTM D570	0.2%

Shrink-Kon® heat-shrinkable tubing

CHS series – Clear thin-wall pvc heat shrink



CHS series thin-wall heat-shrinkable tubing

2:1 Shrink ratio

- Clear shrink enables user to inspect die and crimp details after installation
- Flexible PVC tubing is suitable for industrial and electronic applications
- UL® standard UL224, VW-1 rated
- CSA standard C22.2 no. 198.1 of
- Flame retardant
- Low shrink temperature of 110 °C
- Dielectric strength – 600 V/mil



Cat. no.	Dimensions (in.)			Code cable size (AWG or kcmil)	Standard length (in.)	Std. pkg. qty.
	Min. expanded I.D.	Max. recovered I.D.	Nominal recovered wall			
CHS18	0.13	0.06	0.02	#22-#18	50	1
CHS18B	0.13	0.06	0.02	#22-#18	250	1
CHS14	0.25	0.13	0.03	#16-#10	50	1
CHS14B	0.25	0.13	0.03	#16-#10	250	1
CHS38	0.38	0.19	0.03	#8-#6	50	1
CHS38B	0.38	0.19	0.03	#8-#6	250	1
CHS12	0.50	0.25	0.03	#4-#2	50	1
CHS12B	0.50	0.25	0.03	#4-#2	250	1
CHS34	0.75	0.38	0.04	#1-3/0	50	1
CHS34B	0.75	0.38	0.04	#1-3/0	250	1
CHS100	1.00	0.50	0.04	4/0-300	25	1
CHS100B	1.00	0.50	0.04	4/0-300	100	1
CHS112	1.50	0.75	0.04	350-700	25	1
CHS112B	1.50	0.75	0.04	350-700	100	1
CHS200	2.00	1.00	0.05	750-1000	25	1
CHS200B	2.00	1.00	0.05	750-1000	100	1

Standard package is in reels. Order by reel; not by feet.

CHS series specifications

Property	Test method	Typical performance
Physical		
Tensile strength	ASTM D2671, ISO 37	3300 psi (23.0 MPa)
Elongation	ASTM D2671, ISO 37	300%
Longitudinal change	ASTM D2671	±10%
2% Secant modulus	ASTM D2671	16,000 psi (110 MPa)
Specific gravity	ASTM D792, ISO R1183	1.31
Elongation after heat aging (168 hrs. at 136 °C)	ASTM D2671, ISO 37	250%
Heat shock (4 hrs. at 250 °C)	ASTM D2671	No cracking or flowing
Low-temperature flexibility (1 hr. at 10 °C)	ASTM D2671	No cracking or splitting
Flammability	ASTM D2671	Self extinguishing

Property	Test method	Typical performance
Electrical		
Dielectric strength	ASTM D2671, IEC 243	600 V/mil (24 kV/mm)
Volume resistivity	ASTM D2671	1016 ohm-cm
Chemical		
Fluid resistance	MIL-DTL-23053, ISO 1817, ISO 37	Good to excellent
Copper corrosion	ASTM D2671	No corrosion
Water absorption	ASTM D570	0.3%
Fungus resistance	ASTM G21	No growth

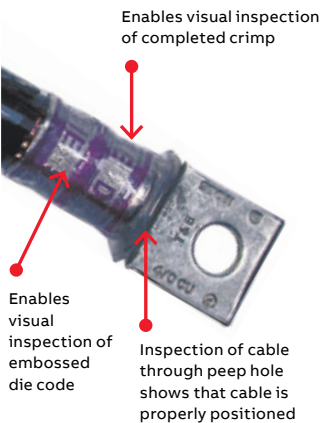

Shrink-Kon® splice insulators and insulating covers

Adhesive insulating covers



- Seals against moisture
- Voltage rating up to 600
- Workable from 14 °F to 120 °F
- Maximum operating temperature of 176 °F
- No installing tools required
- Also available in 10' rolls; consult customer service

Specifications

Electrical

- Dielectric constant: 3.2 ASTM-D150 (60 Hz)
- Power factor: 007 ASTM-D150 (60 Hz)
- Dielectric strength: 340 V/mil ASTM-D1373

Chemical

- Water absorption: 0.06% ASTM-570
- Ozone resistance – Excellent: 03% ASTM-D1373
- Corrosion none visible: per ASTM-D 69

Adhesive insulating covers



Cat. no.	Dimensions (in.)		Std. pkg.
	A	B	
AC 5 x 3	5	3	10
AC 5 x 7	5	7	10
AC 85 x 75	8.5	7.5	5
AC 85 x 105	8.5	10.5	5

Order multiple is std. pkg.

UL listed for use with ABB covers.

For "H" Taps, "C" Taps, two-way connectors, mechanical taps and Color-Keyed* lugs and joints.

Material: 6 mil electrical vinyl backing, butyl rubber mastic adhesive thickness 1/16" approx. Polyethylene release sheet.

UL listed – File No. E9809.

Not for submersion in liquid.

Adhesive insulating covers

Adhesive insulator cat. nos.	Compression														
	Compression lug cat. nos.					Compression two-way connector cat. nos.		"H" tap cat. nos.	"C" tap cat. nos.	Compression cable joints cat. nos.					
AC 5 x 3	60096	60113	60130	60150	54132	54145	54160	54207	54906	54860	60500	54806	63105	54710	54610
size key #2	60097	60114	60132	60151	54134	54108	54162	54208	54942	54862	60501	54807	–	54715	54615
	60099	60116	60134	60230	54105	54147	54163	54255	54947	54864	60507	54806	–	54720	54620
	60101	60117	60135	60236	54135	54148	54111	54209	54909	54866	60512	54504	–	54725	54625
	60102	60118	60136	60238	54136	54150	54165	54210	54910	–	60516	54505	–	54730	54630
	60103	60120	60138	60242	54138	54152	54167	54260	54965	–	60905	54506	–	54735	54635
	60104	60122	60140	60244	54106	54153	54168	54211	54970	–	60910	54507	–	54740	–
	60106	60123	60141	60248	54139	54109	54112	54265	54850	–	60915	54506	–	54745	–
	60107	60124	60142	60250	54140	54155	54170	54212	54852	–	60920	54509	–	54750	–
	60108	60126	60144	54104	54107	54157	54204	54270	54854	–	60925	54510	–	–	–
	60109	60128	60147	54130	54142	54158	54205	54930	54856	–	54804	54511	–	–	–
	60112	60129	60148	54131	54143	54110	54206	54905	54858	–	54805	–	–	–	–

(Continued on next page)

Shrink-Kon® splice insulators and insulating covers

Adhesive insulating covers (continued)

—
Adhesive insulating covers

Adhesive insulator cat. nos.									Compression lug	Compression two-	"H" tap	"C" tap	Compression			
									cat. nos.	way connector	cat. nos.	cat. nos.	cable joints			
								cat. nos.	cat. nos.	cat. nos.	cat. nos.	cat. nos.				
AC 5 x 7 size key #4	-	60152	60169	60267	54173	54115	54129	54222	54920	-	60522	60945	54516	63110	54755	54640
	-	60153	60171	60268	54174	54183	54213	54291	54923	-	60530	60950	54518	63115	54760	54645
	-	60154	60172	60269	54113	54116	54275	54223	54928	-	60538	60955	54809	63120	54765	54650
	-	60156	60174	60271	58161	54185	54214	54295	54868	-	60542	60960	54810	63125	54770	-
	-	60157	60176	60273	58162	54118	54280	54224	54870	-	60548	60965	54811	-	54775	-
	-	60159	60178	60274	58163	54187	54215	54226	54872	-	60554	60970	54812	-	54780	-
	-	60160	60180	60275	58165	54120	54282	54228	54874	-	60560	54509	54813	-	-	-
	-	60162	60254	60276	58166	54122	54216	54913	54876	-	60565	54510	54814	-	-	-
	-	60163	60256	60277	54178	54123	54218	54914	54878	-	60568	54511	54815	-	-	-
	-	60165	60260	60278	54179	54124	54286	54915	54880	-	60571	54512	54816	-	-	-
	-	60166	60262	60280	54114	54126	54220	54916	54882	-	60930	54513	54817	-	-	-
	-	60168	60265	54172	54181	54128	54289	54918	-	-	60935	54514	-	-	-	-
	-	-	-	-	-	-	-	-	-	-	60940	54515	-	-	-	-
AC 85 x 75 size key #6	-	-	-	-	60184	-	-	-	-	-	60574	54522	63130	-	-	-
	-	-	-	-	60284	-	-	-	-	-	60576	54523	63135	-	-	-
	-	-	-	-	-	-	-	-	-	-	60578	54524	63140	-	-	-
	-	-	-	-	-	-	-	-	-	-	60580	54526	63145	-	-	-
	-	-	-	-	-	-	-	-	-	-	60584	54528	63150	-	-	-
	-	-	-	-	-	-	-	-	-	-	60975	54820	-	-	-	-
	-	-	-	-	-	-	-	-	-	-	60980	54823	-	-	-	-
	-	-	-	-	-	-	-	-	-	-	60985	54828	-	-	-	-
	-	-	-	-	-	-	-	-	-	-	54520	-	-	-	-	-
AC 85 x 105 size key #8	-	-	-	-	-	-	-	-	-	-	-	-	63155	-	-	-
	-	-	-	-	-	-	-	-	-	-	-	-	63160	-	-	-
	-	-	-	-	-	-	-	-	-	-	-	-	63165	-	-	-

Diagram

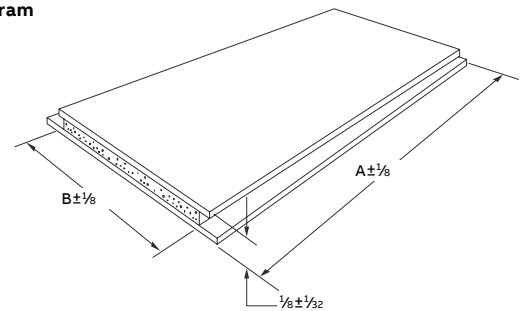

Shrink-Kon® splice insulators and insulating covers

Self-fusing insulation tape

01 TBFT421-36

02 TBFP9-2



01



02

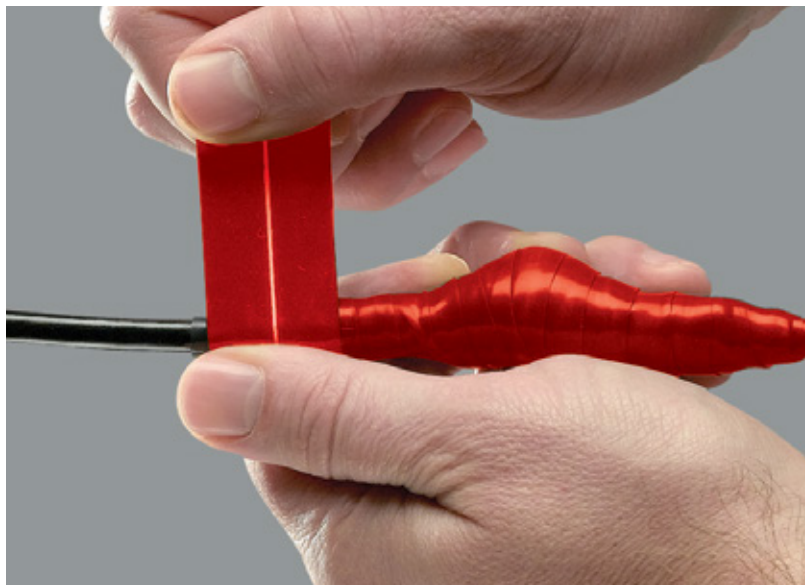

Quick and easy insulation – No heat or adhesive required!

- Just two layers form a moisture-proof, abrasion-resistant, dielectric seal
- Easy-release, non-static-sensitive liner peels right off
- Creates an immediate, permanent bond even when wet
- Suitable for high- and low-voltage applications
- Resistant to UV, moisture and saltwater
- Easily removable – just slice with a knife and pull off – leaves no residue
- Smooth filler putty compound available for use under tape when insulating bolted or dimensionally inconsistent splices and terminations

Typical applications

- Repair deteriorated insulation on cables and conductors
- Insulate and seal underwater, underground and above-ground bonding installations
- Insulate harnessing, bundling, cabling and wiring in aircraft, automotive, marine and other industrial machinery/equipment

Specifications

- Material: Modified silicone rubber compound
- Tensile strength: 1200 psi
- Dielectric strength: 20 mil: 600 vpm; 40 mil: 400 vpm
- Abrasion resistance: 110 lbs./in.
- Water absorption: < 0.5%
- Temperature rating: 80 °C max.
- Voltage rating: 600 V max.

Self-fusing insulation tape



Cat. no.	Width (in.)	Length (ft.)	Thickness (mils)	Color	Std. pkg. qty.
Self-fusing insulation tape					
TBFT421-36	1	36	40	Red	10
TBFT201-36	1	36	20	Black	10
Smooth filler putty compound					
TBFP9-2	1	2.08	–	White	1

Standard package is rolls. Order by rolls; not by feet.

Shrink-Kon® splice insulators and insulating covers

HSTS25 – Tape sealant



- Available in a 25-ft. roll
- Used in conjunction with ABB heat-shrinkable insulators for better moisture sealing

Specifications

Physical

- Description: Butyl rubber polymer
- Application temperature: 40 °F to 100 °F
- Service temperature: -40 °F to 180 °F
- Environmental resistance: Resists ozone and all normal aging processes

Electric

- Dielectric strength: 250 V/mil minimum
- Volume resistivity: 1014 ohms/cm

Chemical

- Chemical resistance: Resists acids, bases and alcohols

Passes Fed. Spec. SS-S-00210, section 3.6

Installation guidelines

- 1) The cable jacket and conductors should be relatively clean and free of greases, oils and other foreign substances.
- 2) It is best to overlap each wrap of tape by $\frac{1}{4}$ to $\frac{1}{2}$ of the width for the best seal.
- 3) When using heat-shrinkable products, most applications require only one or two layers of tape prior to sliding tubing in place.
- 4) Shrink the tubing, cap, boot, etc., following the installation procedure for the applicable heat-shrinkable part.

To seal the junction or crotch of an application requiring two or more cables, conductors, etc. without a common jacket.

- 1) Apply the overlapped one or two layers around each cable, conductor, etc., at the same distance from the connector, or ball up the sealant and press into crotch or junction of the joint.
- 2) Apply two overlapping wraps over the bundle.
- 3) Slide the expanded heat-shrinkable part over the joint and shrink.

HSTS25 – Tape sealant

Cat. no.	Description	Width (in.)	Thickness (in.)	Length (ft.)	Std. pkg. qty.
HSTS25	Tape sealant	1	0.06	25	1

Standard package is reels. Order by reel; not by feet.

Shrink-Kon® insulators and insulating covers

Medium-voltage motor stub splice insulator

Quick and dependable way to insulate and waterproof motor lead connections up to 5 installs in seconds

- Flame retardant
- Flexible boot and impact-resistant cap
- Long lasting and reusable
- Waterproof and abrasion resistant
- One size fits all hookups – Reduces inventory
- Enables easy inspection of connection

This first-generation multi-splice insulator is designed to give you a quick, dependable means of protecting medium-voltage motor stub splice connections up to 5 kV. You can install it in seconds simply by pushing the cover and boot together. Once installed, it completely waterproofs the connection and provides excellent protection against abrasion or mechanical abuse.

One size reduces inventory

The insulator accommodates wire sizes #2 AWG–350 kcmil having outer diameters of 0.375" to 0.840". This range-taking feature should accommodate all of your medium-voltage motor hookups.

Inspectable and reusable

The insulator consists of just two parts: an elastomer boot and thermoplastic cap. The boot has two tapered cable entry legs that fit snugly around the cable to form a watertight seal. The legs are designed to be trimmed during installation to fit the required cable size tightly. The cap simply pushes into a groove in the boot – And pulls out easily when you want to inspect the connection. Removal of the cap does not disturb the seal around the cables, nor does it interrupt the bolted splice connection.

Quality engineered

The boot is made of flexible, abrasion-resistant elastomer, and the cap is made of high impact-resistant thermoplastic – High-performance materials you can depend on. Use the insulator for pigtail applications in motor junction boxes, manholes or wherever a waterproof, impact-resistant insulator is required.

Specifications

- 5 kV wire range: #8–2/0 AWG
- Rating: 90 °C applications
- UL Listed to: 600 V
- CSA certified to: 600 V
- ABB recommended to: 5000 V @ 90 °C
- Material: Cap – NORYL, UL 94V-1
Boot – EPDM Elastomer, UL94V-2 lubricant – Silicone grease



Wide range splice



Cat. no.	Wire range (AWG or kcmil)	Insulation O.D. range (in.)	Bolt max. length (in.)	Dimensions (in.)			Std. pkg. qty.
				Length L	Dia. A	Dia. B Dia. C	
MSCV20	#2–350	0.38–0.84	1.25	6.5	3	2 ^{21/32} 2	5

Diagram

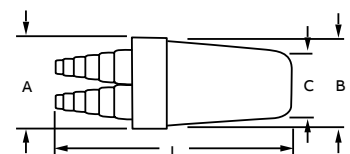

Order in multiples of std. pkg.

Shrink-Kon® splice insulators and insulating covers

Motor stub splice insulators



- Re-enterable motor stub insulator
- Easy installation
- No special tools required

This innovative product has been designed to insulate motor stub splices quickly, easily and dependably. It consists of a boot-type insulator with integral Ty-Rap® cable ties. To install, simply position the insulator over the bolted splice and tighten the cable ties. That's all there is to it. It produces uniform, high-quality installations every time... in about 30 seconds. The completed installation is immediately ready for inspection and use. If required, the insulator can be easily removed. Simply snip the cable ties and slide the insulator off the splice. It leaves no sticky residue.

Specifications

- UL® file E9809. UL and CSA certified (94V-1 flammability class)
- Rated for 600 V and 90 °C application

Material

- Body: Modified neoprene elastomer
- Straps: Nylon

Motor stub splice insulators



Diagram	Cat. no.	Wire range		Dimensions (in.)						Std. pkg. qty.
		(AWG or kcmil)	Length	Bolt max.	B Dia.	C Dia.	D	E		
	MSC14*	#14-#10	3.38	1.5	0.56	0.50	0.38	0.35	15	
	MSC8	#12-#8	3.38	2.39	0.73	0.67	0.38	1.20	10	
	MSC2	#12-#2	0.75	3.25	0.95	0.88	0.38	1.5	10	
	MSC20	#2-2/0	1.5	4.25	1.39	1.05	0.43	1.70	4	
	MSC250	3/0-300	1.5	7.56	1.88	1.80	0.45	1.90	2	
	MSC500	350-500	1.75	8.88	2.56	2.48	0.45	2.10	5	

Order in multiples of std. pkg.

*One Ty-Rap® cable tie only

Insulator connectors

Insulator cat. no.	Wire range (AWG or kcmil)	Lugs						Terminals	Max. bolt length (in.)	
		2-Hole Color-keyed® lugs (Al-Cu wire)	1-Hole Color-Keyed® lugs (Al-Cu wire)	2-Hole cast copper lugs (Cu wire)	1-Hole cast copper lugs (Cu wire)	2-Hole Color-Keyed® lugs (Cu wire)	1-Hole Color-Keyed® lugs (Al-Cu wire)			
MSC14	#14-#10	-	-	-	-	-	-	14RB4-14RB10 RB14-4-RB14-10	10RC6-10R1C0 RC10-6-RC10-10	¾
MSC8	#12-#8	-	60096 60097 60101 60102	-	53104	-	54104	-	-	¾
MSC2	#12-#2	-	60099 60103- 60118	53204 53205 53206	54105 54106	54204 54205 54206	54105 54106	-	-	¾
MSC20	#2-2/0	60230 60236	60118- 60138	53207 53208	53107 53108	54207 54208	54107 54108	-	-	1
MSC250	3/0-300	20238- 60256	60140- 60157	53209- 53113	53109- 53113	53209- 54214	54109- 54114	-	-	1½
MSC500	350-500	60260- 60273	60165- 60172	53115- 53118	53115 53118	54215- 54218	54115- 54118	-	-	1¾

Shrink-Kon® installation tools

Electric heat gun



- UL® Listed
- 600 °F to 950 °F heat range
- 120 V AC 60 Hz

Electric heat gun



Cat. no.	Description	Pkg. qty.
WT1400	Dual-temp. heat gun. 600 °F/950 °F, 1,300 W, 120 V AC, 60 Hz	1

Order multiple is std. pkg.

Portable heat-shrink torch



Separate fuel- and air-flow controls enable precise adjustment of flame and temperature up to 2,500 °F!

- 2,500 °F output capacity satisfies virtually any heat-shrink, brazing or soldering requirement
- Dual fuel- and air-flow controls enable separate adjustment of temperature and flame precision
- Brass and steel construction provides durability

Specifications

- Dimensions (without base): 3.9"L x 1.4"W x 5.4"H
- Weight (when filled): 9.88 oz.
- Fuel tank capacity: 2.03 fl. oz.
- Operating time (per full fuel tank): up to 220 minutes
- Operates on standard butane refills



Portable heat-shrink torch

Cat. no.	Description	Std. pkg. qty.
WT-PTORCH	Portable heat-shrink torch	1

Order multiple is std. pkg.

Shrink-Kon® installation tools

Installation

— 01 Connector and heat-shrinkable tubing prior to installation.

— 02 Crimp connector installed.

— 03 Heat-shrinkable tubing in position.

— 04 Heat-shrinkable tubing after heat application.

- 1) Remove any oil, grease, water, dirt, etc., by wiping the cable ends and connector. Remove all sharp edges and burrs from connector.
- 2) Center tubing over splice connector.
- 3) Use the light blue outer portion of the flame when using the SIT-1 torch. Do not hold the torch still in one position or concentrate the hot inner flame of the torch on the tubing; this may cause scorching.
- 4) Begin heating tubing in the center. Recover the central portion of the tubing first by heating around the circumference of the splice. (Keep heat source moving constantly around the circumference of the insulator to ensure uniform shrinkage of the insulator).
- 5) Continue heating around the tubing and out toward one end. Move torch around the tubing until one end is completely recovered.
- 6) Repeat the above procedure on the opposite end of the splice, again working from the center outward and around the tubing.
- 7) Installation is complete when the tubing conforms to splice and sealant flow is apparent at both ends.

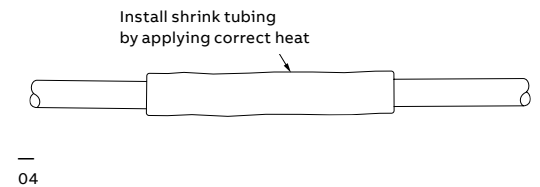
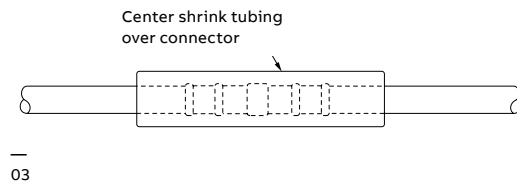
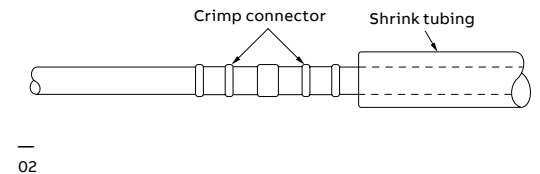
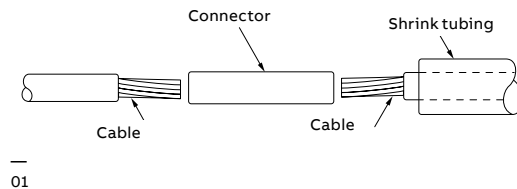

Shrink-Kon® installation tools

Typical specifications

Insulating and sealing of all 600 V, in-line cable splices from #16 AWG through 1000 kcmil shall be done in accordance with the instructions provided with the Shrink-Kon heat-shrinkable insulators, catalog series HS.

The connector insulator must be made of thermally stabilized, homogeneous polyolefin having internally applied sealant. It must have Underwriter's Laboratories Listing (UL® 486, 90 °C, 600 V) and be approved for the use. It must be usable without additional covering or adhesive both indoors and outdoors, in overhead, direct-burial or submersed applications at rated voltage. It must not be adversely affected by moisture, ozone, oils, fuels, mild acids and alkalis or ultraviolet light. It must be compatible with all commonly used cable jacket materials, including rubber, plastic, lead, steel, aluminum and copper.

Factory-applied sealant

A standard sealant is coated on the entire inside surface of most pre-cut sizes. Tubing is also available without sealant – Consult factory. The sealant is rated for continuous 90 °C operation on non-pressurized cable systems and aids in sealing out moisture and corrosion.

Cost and reliability of heat-shrinkable tubing compared to tape

The cost differential in the installation of ABB heat-shrinkable tubing over taping can result in up to a 34% savings in labor and overhead. For example, on a 2/0 AWG aluminum splice, heat-shrinkable tubing can be installed in three minutes, versus 10 minutes of taping. In addition to the direct cost reduction, there are the advantages of assured uniformity of wall thickness and moisture sealing.

Cross reference

ABB	Panduit	3M	Raychem	Sumitomo	Alpha	Coleflex	Insultab
CPO	HSTT	FP 301 (1 & 2)	RNF 100 (1 & 2)	A2 & B2	FIT 221	ST221 / STS221 STU221 / STSU221	HS 101
CPO-A	HSTTA & HSTTVA	EPS300	TAT 125 ATUM 3:1	W3B2	FIT321	ST303	HS101 MW 3:1
HSMW	-	-	MWTM (U) BSTS-M / SST-M	-	-	-	CTV
HS	-	-	WSCM / SST	-	FIT 700	-	-
HS FR	HST	HDT	BSTS FR / SSTFR WCSF / FCSM	-	-	-	CTVH
HSC	HSEC	ICEC	S3C/ESC SSC-FR / ESC-FR	-	-	TYT	-
CPO-HF	-	-	-	NH	-	-	-
HSM-HF	-	-	XFFR	-	-	-	-
CHS	HSTTPN	-	-	-	-	-	-

These competitor names are the property of the respective competitor.

Shield-Kon[®] shield termination system

Shield-Kon – Save time and money over traditional connection methods!

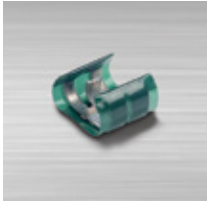

01 One-piece
Shield-Kon connector

Wherever shielded cables and wires are fitted, there is the problem of finding a permanent, repeatable, safe and quick connection of the braided shield.

Conventional connection methods use soldering, which is more time-consuming and more expensive, and can often result in damage to the dielectric or to the internal shield conductor caused by heat. Moreover, the use of lead-based soldering methods can be in conflict with the latest safety regulations.

The Shield-Kon solution from ABB involves a crimp technique for shield termination on shielded cables. The reliability of Shield-Kon terminals has led to a specification for the aeronautical and space technology industry and for military applications (MIL-F-21608).



02 Two-piece
Shield-Kon connector

ABB offers two solutions:

- The one-piece Shield-Kon connector wraps around the shield and has a specific pocket for the ground wire
- The two-piece Shield-Kon connector consists of two sleeves that are compressed between the shielded braid and the drain wire

The essential advantages are clearly visible:

- Saves time and reduces assembly costs
- Safe monitoring
- Simple operation
- Low-profile and compact connectors
- Tried and tested technology
- Quality grounded connections



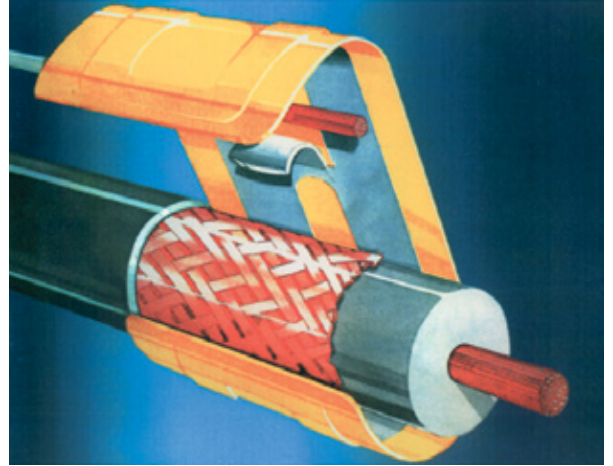

Terminate shielded cable in seconds without heat or power!

This solderless, wraparound connector terminates shielded cable in seconds... with uniform precision. It's particularly well suited for production work in aircraft, aerospace and electronic industries where size and weight are important.

Once crimped, it provides a compact, lightweight, low-resistance, high-strength connection, which meets and exceeds the performance requirements of MIL-F-21608.

The connector works equally well on braided, wrapped or foil shields and has the added advantage of being able to be used as a mid-span termination.

Only four sizes, which can be easily identified by the color of their insulation, are needed to cover a range of shielding diameters from 0.05" to 0.3".

- Compact, low-profile connector
- One piece wraparound design
- Tough polyester insulation (Mylar® type)
- Inventory savings: only four sizes
- Transparent insulation, easily inspected
- MIL-specified, industry-approved technology
- No heat or power required to install
- No damage to inner conductor
- Less installation time required
- Uniform, precise connection every time
- Low installed cost
- Mid-span termination possible, eliminating the need to demount a cable already installed

The one-piece Shield-Kon® connectors meet the MIL-F-21608 standards for the following environmental specifications:

- Voltage Drop: 9 mV max. at 1 A after environmental exposure
- Insulation Dielectric Strength: 500 VRMS at 60 Hz for 1 minute
- Corrosion Resistance: 48 hours in 5% salt fog
- Pullout Strength: 15 lbs. min. for #22 AWG, and 19 lbs. min. for #20 AWG
- Vibration: 0.03" double amplitude between 10 and 55 Hz for 6 hours on each of two axis
- Material: Copper, conform to CDA No. 110
- Plating: Tin, electro-plated (thickness 3 to 8 μm), in accordance with MIL-T-10727A
- Insulation: Polyester film (Mylar type), color coded for size identification
- Temperature: -85 °F to +257 °F (-65 °C to +125 °C)

In addition, hypot tests have shown that the cable manufacturers' specified working voltage rating is maintained after the installation of Shield-Kon RSK connectors. It is, however, still advisable to evaluate the suitability of these connectors and verify their performance for the particular application.

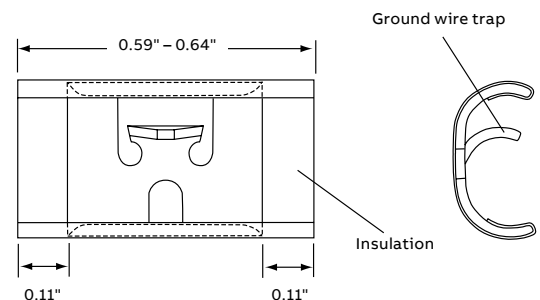

Shield-Kon® shield termination system

Shield-Kon RSK connectors

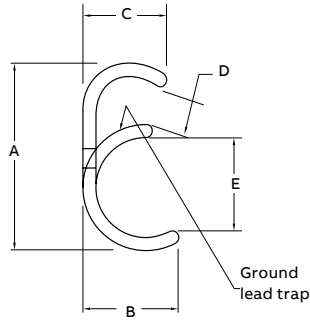





How to use connector die and tool selection chart:

1. Use a calibrated measuring tool lightly over shield for most accurate measurement. Rotate shielded wire to pick up high spots on cable. Use "Shield Diameter" column to match the measured dimension.
2. Select connector and die for ERG740 tool.

Note:

1. Do not solder-dip ends of ground leads.
2. For ground wire combinations not covered in table, consult Technical Service.

One-piece Shield-Kon connectors & die selection table

Connector & color cat. no.	Color	Shield diameter mm (in.)	Metal dies for ERG740	Ground wire range (AWG)	Application tool cat. no.
RSK101 	Red	1.27–1.78 (0.050–0.070)	D-101A	(1) or (2) #24 Str.	Hand tool ERG740
		1.80–2.26 (0.071–0.089)	D-101B	or (1) #22 Str.	
RSK201 	Blue	2.29–2.54 (0.090–0.100)	D-201C	(1) or (2) #22 Str.	
		2.56–3.00 (0.101–0.118)	D-201D	or (1) #20 Str.	
		3.022–3.33 (0.119–0.131)	D-201E		
		3.35–3.63 (0.132–0.143)	D-201F		
RSK301 	Yellow	3.66–4.11 (0.144–0.162)	D-301G	(1) or (2) #22 Str.	
		4.14–4.70 (0.163–0.185)	D-301H	or (1) or (2) #20 Str.	
		4.72–5.10 (0.186–0.201)	D-301J		
RSK401 	Green	5.13–5.84 (0.202–0.230)	D-401K	(1) or (2) #20 Str.	
		5.87–6.35 (0.231–0.250)	D-401L	or (1) #18 Str.	
		6.37–6.98 (0.251–0.275)	D-401M		
		7.01–7.62 (0.276–0.300)	D-401N		

Cat. no.	Color	Dimensions (in.)						Std. pkg.
		A	B	C	D	E	Thickness	
RSK-101	Red	0.31	0.16	0.18	0.06	0.15	0.02	1,000
RSK-201	Blue	0.38	0.22	0.18	0.06	0.18	0.02	1,000
RSK-301	Yellow	0.47	0.28	0.24	0.07	0.22	0.03	1,000
RSK-401	Green	0.69	0.43	0.37	0.08	0.37	0.03	500

Order multiple is std. pkg.

Shield-Kon® shield termination system

Installation methods and installation procedure

Installation methods

- 01 Standard method
- 02 Fold-back method 1
- 03 Fold-back method 2
- 04 Mid-span method

Standard method

Use the standard method when the shielded cable or the inner conductors are embedded in a dielectric.

Fold-back method 1

If there is no common dielectric for several interior cables but the gaps are filled by textile threads or something similar, care should be taken to ensure that the insulating thickness of the individual cables is not less than 0.38mm for PVC,

and not less than 0.25mm for Teflon. If this insulation thickness falls below this value, Fold-Back Method 1 should be used.

Fold-back method 2

Fold-back method 2 should be used if the cable shield is applied spirally or if a foil shield is being used.

Mid-span method

Enables installation anywhere along the cable.

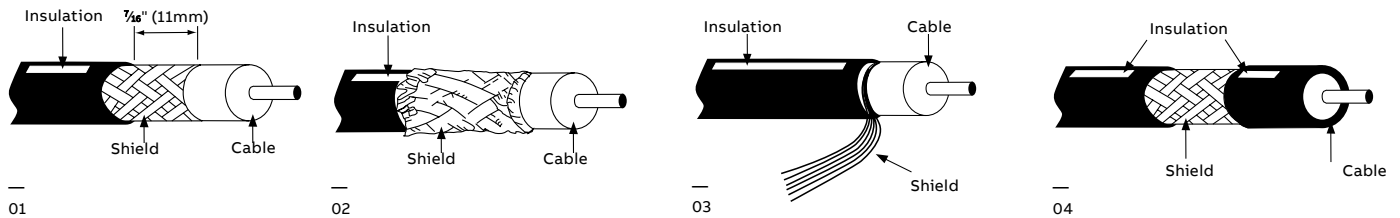

Installation procedure

- 01 Step 1
- 02 Step 2*
- 03 Step 3*

Step 1

Prepare shielded wire and ground wire insulation as shown. If two ground wires are required in a Shield-Kon connection, twist both conductors before insertion into the connector.

Step 2*

Select the appropriate connector according to the size of the shielded cable (see page 108). Place the ground wire around the trap hook and the shielded wire into the bottom of the connector. When inserting the shielded cable and grounding wire, care must be taken to ensure that their insulation is overlapped by the connector's polyester insulation film. 100% insulation is possible after crimping when the stripped length of outer jacket (visible shielding) is $\frac{1}{16}$ " (11 mm) maximum.

Step 3*

Select the appropriate die set for the crimp tool, according to the size of the shielded cable (see page 108) and mount the dies on the tool. Insert the connector (with the shielded cable and the ground wire) between the dies of the tool. Squeeze the tool handles firmly to crimp the connector around the shielding and the ground wire.

*For a complete listing of One-piece connector dies, see page 108.

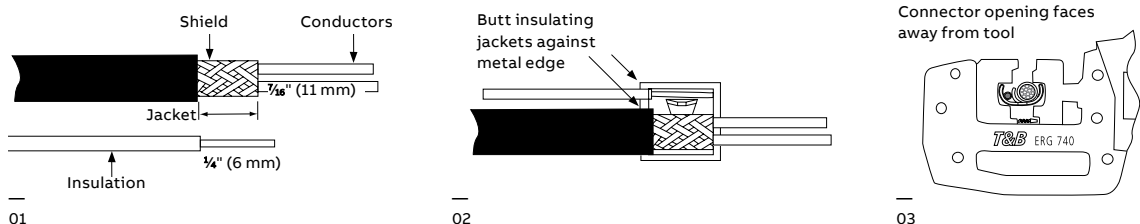

Shield-Kon® shield termination system

Shield-Kon ergonomic hand tool for one-piece connectors



Comfort and versatility!

- Robust construction: metallic frame, partially covered with plastic
- Use with metal dies for low-, medium- or high-volume applications
- All dies are easily interchangeable (to be ordered separately)
- Parallel action crimp
- ShureStake® mechanism: once pressing has commenced, the tool can be re-opened only after successful completion of the crimping cycle

Specifications

- Dimensions of tool:
8.27"L x 6.10"W x 0.98"H
- Weight of tool: 1.04 lbs.

Shield-Kon ergonomic hand tool for one-piece connectors

Cat. no.	Description	Std. pkg.
ERG740	Ergonomic hand tool	1

Ergonomic hand tool kit



Everything you need in a handy kit!

Same as ERG740, but supplied in a plastic case with one tool, one benchmount stand for easier use in mass production, one RSK-LEHRE gauge for instant selection of the die and four metal dies: D-101A, D-201C, D-301J, D-401M.

Specifications

- Dimensions of plastic case:
9.65"L x 8.27"W x 2.17"H
- Weight of plastic case & contents: 2.65 lbs.

Ergonomic hand tool kit

Cat. no.	Description	Std. pkg.
ERG740-01	Ergonomic hand tool kit	1

Shield-Kon® shield termination system

Metal dies for ERG740



- For mass production and medium to high volumes
- Made of hardened steel – Does not wear
- Only for the ERG740 hand tool
- The product ref. is engraved on the upper part and on the lower part of the die set
- Marked with a dot having the same color as the corresponding connector
- Weight – Approximately 2.6 oz.

Metal dies for ERG740

Die cat. no.	Die color	Shield diameter (in.)	For connector	Std. pkg.
D-101A	Red	0.050–0.070	RSK 101 Red	1
D-101B		0.071–0.089	RSK 101 Red	1
D-201C	Blue	0.090–0.100	RSK 202 Blue	1
D-201D		0.101–0.118	RSK 202 Blue	1
D-201E		0.119–0.131	RSK 202 Blue	1
D-201F		0.132–0.143	RSK 202 Blue	1
D-301G	Yellow	0.144–0.162	RSK 301 Yellow	1
D-301H		0.163–0.185	RSK 301 Yellow	1
D-301J		0.186–0.201	RSK 301 Yellow	1
D-401K	Green	0.202–0.230	RSK 401 Green	1
D-401L		0.231–0.250	RSK 401 Green	1
D-401M		0.251–0.275	RSK 401 Green	1
D-401N		0.276–0.300	RSK 401 Green	1

Order multiple is std. pkg.

RSK-LEHRE gauge

Select the connectors you need quickly!

The choice of the appropriate connector and die set mainly depends on the size of the shielded cable. The selection can be done very quickly with the RSK-LEHRE gauge.

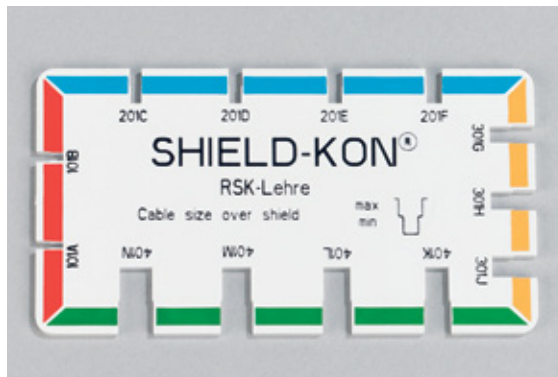

RSK-LEHRE gauge

Cat. no.	Description	Std. pkg.
RSK-LEHRE	Connector & die gauge	1

1) Remove the outer jacket from the shielded cable, making the shielding visible.

2) Insert this stripped end of the cable into the slots located around the gauge. The correct slot will be found when the cable can slide only in the upper part of the slot. If the cable can slide completely to the bottom of the slot, you should try with the smaller adjacent slot.

3) Once the appropriate slot is found, the corresponding RSK connector is defined by the color of the strip around the slot, whereas the corresponding plastic die set is given by the number marked below the slot (for the metal die set, add prefix "D" to this number).

4) The table on page G-80 summarizes the different combinations of connector/die set, as well as the size of ground wire that can be used.

Shield-Kon® shield termination system

- 01 Circular range
- 02 Hexagonal range

Unique shield termination system gets the job done right!

The Shield-Kon two-piece shield termination system from ABB consists of two sleeves: an inner sleeve with a smaller diameter, and an outer sleeve that has a larger diameter but is shorter and less hard than the inner sleeve. All inner and outer sleeves are color coded according to their size.

The conductors of the cable are inserted through the inner sleeve, whereas the shield (braided or foiled) and the ground wire are inserted between the two sleeves. The crimp operation is done by compressing the outer sleeve with a tool, while the inner sleeve provides mechanical protection for the inner conductors.

This unique shield termination system can be used with cables having a diameter of dielectric (after removing the outer insulation and the shield) between 0.043" and 2.87".

In the “Hexagonal Range” (diameters of dielectric

between 0.043" and 0.38"), the outer sleeve is crimped with a hand tool and the result is a hexagonal-shaped crimp. This range is used to crimp shielded and coaxial cables.

The “Circular Range” for multiple or overall shielded cables refers to larger diameters of dielectric (between 0.39" and 2.87") and owes its name to the circular shape of the crimp.

Two-piece connector – The hexagonal range

The ABB hexagonal compression (for diameters of dielectric up to 0.37") is a reliable method for grounding, terminating and insulating shielded and coaxial cable.

It has literally millions of installations in communications, aerospace, electronic, telephone, radio and TV applications.



01



02

Shield-Kon® shield termination system

Quick and neat terminations made easy!

Three installation methods are possible in the hexagonal range for a quick, neat and accurately completed termination...at a greatly reduced production cost.

Standard

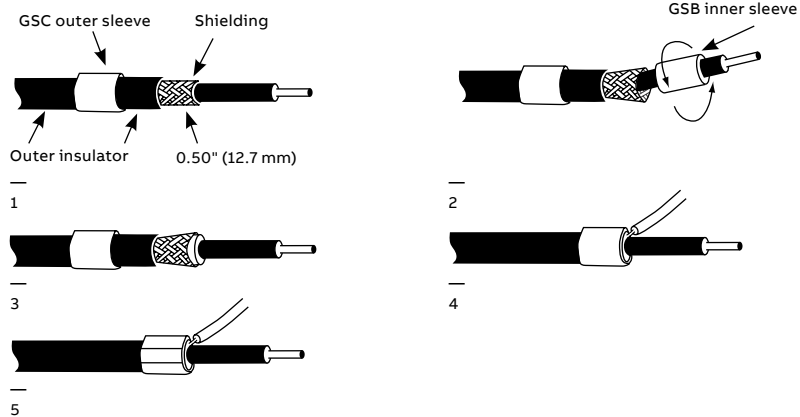

Method 1: Standard

1. After stripping the shield (0.50" in length), slip the outer sleeve over the outer insulation. If this is too big, slip the outer sleeve on, after technique described in Method 3.
2. Widen the braided shield by gently rotating the inner conductor, then slip the inner sleeve under the braided shield.
3. Position the inner sleeve so that about 0.06" protrudes beyond the end of the braided shield.
4. Slip the ground wire (#22-#20 AWG) under the outer sleeve (from the front or behind) and slip the outer sleeve over the braided shield.
5. Position the outer sleeve and ensure that the ends of all wires in the braided shield and ground wire are covered. Crimp both sleeves with the correct tool and die. Finished.

Fold back

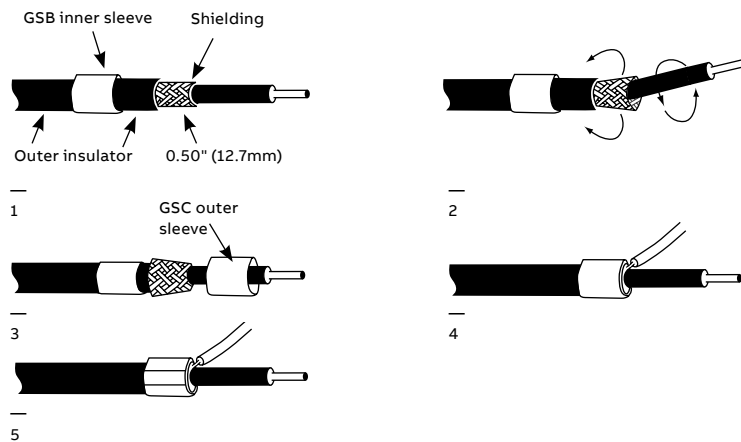

Method 2: Fold back

1. After stripping the shield (0.50" in length), slip the inner sleeve over the outer insulation.
2. Widen the braided shield by gently rotating the inner conductor.
3. Fold back the braided shield over the inner sleeve and slip the outer sleeve over the braided shield.
4. Slip the drain wire (#22-#20 AWG) under the outer sleeve (from the front or behind) and slip the outer sleeve over the braided shield.
5. Position the outer sleeve and ensure that the ends of all wires in the braided shield and ground wire are covered. Crimp both sleeves with the correct tool and die. Finished.

Large insulation

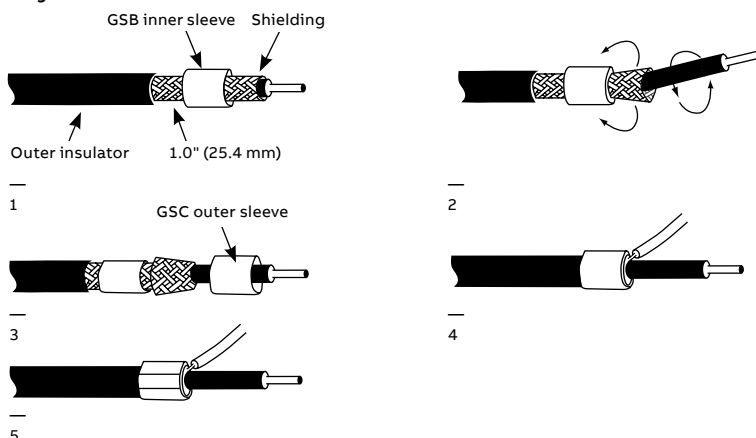

Method 3: Large insulation

1. After stripping the shield (1.0" in length), slip the inner sleeve over the braided shield.
2. Widen the braided shield by gently rotating the inner conductor.
3. Fold back the braided shield over the inner sleeve and slip the outer sleeve over the braided shield.
4. Slip the ground wire (#22-#20 AWG) under the outer sleeve (from the front or behind) and slip the outer sleeve over the braided shield.
5. Position the outer sleeve and ensure that the ends of all wires in the braided shield and ground wire are covered. Crimp both sleeves with the correct tool and die. Finished.

Shield-Kon® shield termination system

Select connectors and dies in three easy steps!

The choice of the appropriate combination of inner sleeve, outer sleeve and crimp tool/die will depend on the diameter of the dielectric.

However, a direct correlation with the diameter of the dielectric is not possible, because several different inner sleeves can be combined with the same outer sleeve (according to the type of shield).

With the directions shown below, a measuring instrument (caliper) is all that is required to make the right selection in three steps:

1. Selection of the inner sleeve (GSB)

- Strip the outer insulator and remove the shield
- Measure the maximum value of the diameter of the dielectric (diameter without shield) by gently rotating the cable. When doing so, it should be possible to turn the cable easily between the jaws of the caliper
- Add 0.01" to the measured value. The sum will give the Inner Diameter (I.D.) of the GSB inner sleeve
- In the table on page 115, select the GSB inner sleeve having this I.D. or the nearest larger I.D.

2. Selection of the outer sleeve (GSC)

Normal method:

- Slide the selected inner sleeve underneath the shield of the cable
- Measure the maximum diameter with the shield over the inner sleeve
- Add 0.03" to the measured value. The sum will give the Inner Diameter (I.D.) of the GSC sleeve
- In the table on page 115, select the GSC outer sleeve having this I.D. or the nearest larger I.D.

Quick method:

In most cases, a quicker method can be used to define the correct GSC outer sleeve:

- Once the appropriate GSB inner sleeve is found, the table on page 115 will give the Outer Diameter (O.D.) of this GSB sleeve
- Add 0.06" to this O.D. and the sum will give the Inner Diameter (I.D.) of the GSC sleeve
- In the table on page 115, select the GSC sleeve having this I.D. or the nearest larger I.D.

3. Selection of the die

- Dies for GSB/GSC Shield-Kon can be found on page 115.
- Tools for GSB/GSC Shield-Kon can be found on page 116. See GSC outer sleeve table.

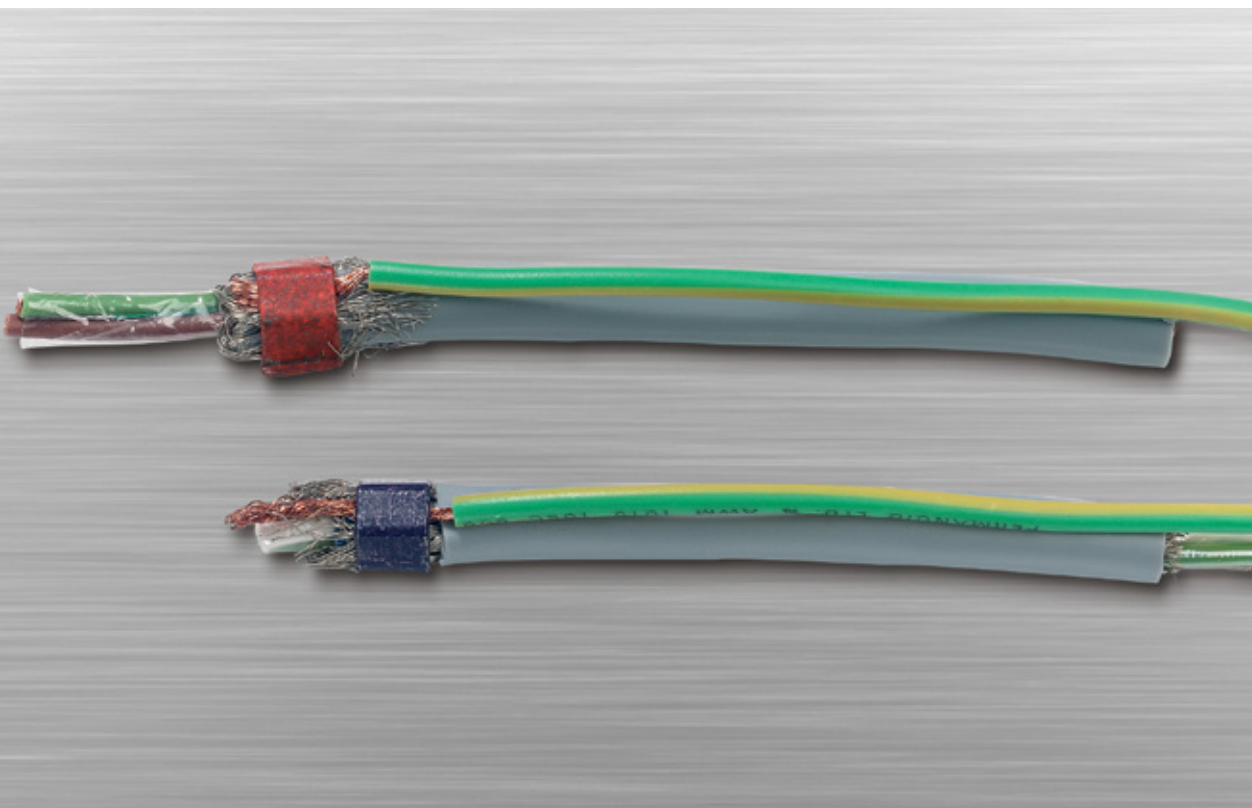

Shield-Kon® shield termination system

Connector inner and outer sleeves

—
01 Non-insulated
inner sleeve – GSB

—
02 Non-insulated
outer sleeve – GSC

Stay grounded with easy-to-install connectors!

- Hard bronze inner sleeve is installed under braid
- Length $\frac{5}{16}$ "
- Tin plated per MIL-T-10727A

- Soft bronze outer sleeve slips over the braid and ground wire
- Length $\frac{1}{4}$ "
- Tin plated per MIL-T-10727A



01

Inner sleeves

Cat. no.	Color code	Dimensions (in.)		Military spec. no.	Std. pkg.
		I.D.	O.D.		
GSB046	Gray	0.046	0.075	21981-046	1,000
GSB058	Yellow	0.058	0.083	21981-058	1,000
GSB063	Red	0.063	0.088	21981-063	1,000
GSB071	Green	0.071	0.096	21981-071	1,000
GSB080	Blue	0.080	0.103	21981-080	1,000
GSB090	Orange	0.090	0.113	21981-090	1,000
GSB096	Purple	0.096	0.119	21981-096	1,000
GSB101	Yellow	0.101	0.124	21981-101	1,000
GSB109	Red	0.109	0.131	21981-109	1,000
GSB115	Gray	0.115	0.146	21981-115	1,000
GSB124	Green	0.124	0.145	21981-124	1,000
GSB128	Gray	0.128	0.152	21981-128	1,000
GSB134	Orange	0.134	0.156	21981-134	1,000
GSB149	Blue	0.149	0.179	21981-149	1,000
GSB156	Red	0.156	0.193	21981-156	1,000
GSB165	Gray	0.165	0.194	21981-165	1,000
GSB175	Green	0.175	0.215	21981-175	1,000
GSB187	Yellow	0.187	0.227	21981-187	1,000
GSB194	Blue	0.194	0.226	21981-194	1,000
GSB205	Orange	0.205	0.245	21981-205	1,000
GSB219	Gray	0.219	0.250	21981-219	1,000
GSB225	Yellow	0.225	0.256	21981-225	1,000
GSB232	Red	0.232	0.263	21981-232	1,000
GSB250	Green	0.250	0.281	21981-250	1,000
GSB261	Blue	0.261	0.297	21981-261	1,000
GSB266	Gray	0.266	0.297	21981-266	1,000
GSB275	Orange	0.275	0.306	21981-275	1,000
GSB281	Yellow	0.281	0.331	21981-281	1,000
GSB287	Gray	0.287	0.327	21981-287	1,000
GSB297	Red	0.297	0.335	21981-297	1,000
GSB312	Purple	0.312	0.362	21981-312	1,000
GSB348	Orange	0.348	0.400	21981-348	1,000
GSB375	Blue	0.375	0.406	21981-375	1,000

Order multiple is standard package.



02

Outer sleeves

Cat. no.	Color code	Dimensions (in.)		Tools		Military spec. no.	Std. pkg.
		I.D.	O.D.	Die nos. for WT440/ WT540*	Die nos. for 11901A		
GSC101	Gray	0.101	0.124	4419	11989	21980-101	1,000
GSC128	Blue	0.128	0.152	4400	11970	21980-128	1,000
GSC149	Purple	0.149	0.179	4401	11971	21980-149	1,000
GSC156	Yellow	0.156	0.193	4402	11972	21980-156	1,000
GSC175	Blue	0.175	0.215	4403	11973	21980-175	1,000
GSC187	Orange	0.187	0.227	4406	11976	21980-187	1,000
GSC194	Red	0.194	0.226	4406	11976	21980-194	1,000
GSC199	Gray	0.199	0.235	4406	11976	21980-199	1,000
GSC205	Yellow	0.205	0.245	4408	11978	21980-205	1,000
GSC219	Green	0.219	0.250	4408	11978	21980-219	1,000
GSC225	Purple	0.225	0.256	4409	11979	21980-225	1,000
GSC232	Orange	0.232	0.263	4410	11980	21980-232	1,000
GSC261	Yellow	0.261	0.297	4411	11981	21980-261	1,000
GSC275	Gray	0.275	0.306	4412	11982	21980-275	1,000
GSC281	Purple	0.281	0.331	4414	11984	21980-281	1,000
GSC287	Blue	0.287	0.327	4414	11984	21980-287	1,000
GSC297	Green	0.297	0.335	4414	11984	21980-297	1,000
GSC312	Yellow	0.312	0.362	4415	11985	21980-312	1,000
GSC327	Gray	0.327	0.372	4416	11986	21980-327	1,000
GSC348	Orange	0.348	0.393	4417	11987	21980-348	1,000
GSC359	Purple	0.359	0.399	5450	–	21980-359	1,000
GSC375	Yellow	0.375	0.406	5451	–	21980-375	1,000
GSC405	Red	0.405	0.453	5452	11988	21980-405	1,000
GSC415	Blue	0.415	0.463	5452	11988	21980-415	1,000
GSC425	Gray	0.425	0.475	5454	–	–	1,000
GSC460	Gray	0.460	0.510	5456	–	21980-460	1,000
GSC500	Green	0.500	0.550	5457	–	21980-500	1,000

*Dies 4419 to 4417 are for WT440. Dies 5450 to 5457 are for WT540.
Order multiple is standard package.

Shield-Kon® shield termination system

WT440 and WT540 ratchet hand tools



- Parallel-action hand tools
- MIL specified
- Frame, with the option of interchangeable steel dies
- A versatile tool, one frame with a selection of dies covers the whole range of shield diameters in the hexagonal range
- ShureStake® mechanism: once pressing has started, the tool can be re-opened only after successful completion of the crimping cycle
- Packaging: wood box containing one frame (dies to be ordered separately; see specifications for die nos.)

Specifications

WT440

- Length: 8"
- Weight: 1.0 lbs.
- Dies: Series 4400

WT540

- Length: 10.4"
- Weight: 1.19 lbs.
- Dies: Series 5450

WT440 and WT540 ratchet hand tools

Cat. no.	Description	Std pkg.
WT440	Ratchet hand tool	1
WT540	Ratchet hand tool	1

Shield-Kon® shield termination system

Multi-shielded cable connector installation procedure

The design advantages are:

- Positive selection of inner and outer sleeves and installing die by a complete color-coded system
- A more reliable grounding termination because only one ground wire connection is made – conventional daisychain jumper method is eliminated
- Smaller, more compact bundle is easy to inspect
- Only one ground wire is required; however, additional ground wires may be used if needed
- Smooth insulator protects conductor insulation
- With one stroke of the tool, the interlace die will produce a 360° compression, uniformly securing all individual shields around the connector

The Shield-Kon connector system for multiple-conductor shielded cable is based on the principle of cold swaging. It utilizes a two-piece compression connector color coded to match the proper die. The connector consists of a hard brass collector inner ring with a tough, smooth insulator and a soft copper compression outer ring. Each set of rings and matching installing die will connect a minimum of five shielding braids with one ground wire. The maximum number of braids is limited only by the space between the inner and outer rings.

Terminate multiple-conductor shielded cable quickly and easily!

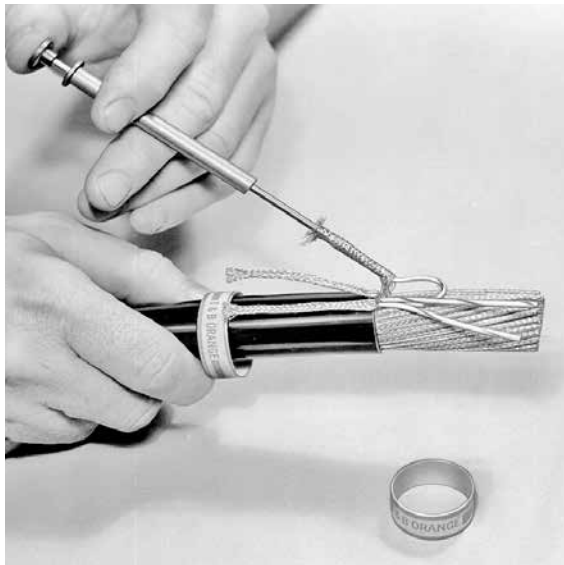

Step 1

After overall insulation is removed to expose shielded cables, each conductor must be freed from the shielding braid. The ABB lead extractor tool simplifies this operation by pushing the inner conductor through an opening in the shielding braid. The braid is then folded back until all conductors are freed.



Step 2

Flattened shielding braids are evenly distributed around the periphery of the inner collector ring.

(Continued on next page)

Shield-Kon® shield termination system

Multi-shielded cable connector installation procedure (continued)



Step 3

Position outer compression ring over the flattened shielding braid, locating it over the center of the inner collector ring. Braid may be trimmed even with the edge of the outer compression ring before or after compression. Ground wire or wires may be inserted between the outer compression ring and the shield prior to compression.



Step 4

Selection of compression dies is determined by color coding on rings. The dies are color coded to match the rings. The appropriate dies are easily inserted or removed by depressing die-locking button shown.



Step 5

The prepared cable is placed in the installing die and compressed. Tool operates on hydraulic power output, developing 9800 ±200 psi operating pressure.

Step 6

Completed installation of the “single fold–fold forward” method typifies the reliability, compactness and neatness that is obtained with all ABB recommended installation methods.

Shield-Kon® shield termination system

Two-piece connectors for multiple conductor shielded cable

Connector and die selection in the circular range

The choice of the appropriate combination of inner ring, outer ring and crimp tool/die depends on the overall diameter of the inner conductors (underneath the shield).

In the case of the circular range, there is a direct correlation between the diameter of the inner conductors and the inner and outer rings. With the directions (shown below), a measuring instrument (caliper) is all that is required to make the right selection.

Selection of the GSB inner ring

- Measure the maximum value of the overall diameter of the inner conductors (underneath the flattened shield) by gently rotating the cable. When doing so, it should be possible to turn the cable easily between the jaws of the caliper.
- Add 0.060" to the measured value. the sum will give the inner diameter (I.D.) of the GSB inner ring.
- In the table, select the GSB inner ring having this I.D. or the nearest larger I.D.

Selection of the GSC outer ring and of the die

Once the appropriate GSB inner ring is found, the table (below) immediately gives the corresponding GSC outer ring and the appropriate die for the 13640 hydraulic head.

Specifications

Inner sleeve

- Material: copper alloy ASTM B135
- Finish: electro tin-plated (per MIL-T-10727A)

Outer sleeve

- Material: copper ASTM B188
- Finish: electro tin-plated (per MIL-T-10727A)

Connectors come full circle
with circular connectors!

Two-piece connectors for multiple conductor shielded cable

Cat. no.	Color code	Dimensions (in.)		Std. pkg.
		I.D.	O.D.	
Inner sleeves				
GSB430	Red	0.430	0.500	50
GSB550	Blue	0.550	0.620	50
GSB670	Gray	0.670	0.750	50
GSB810	Brown	0.810	0.880	50
GSB920	Green	0.920	1.000	50
GSB1040	Pink	1.040	1.120	50
GSB1353	Yellow	1.353	1.423	50
GSB1425	Red	1.425	1.545	50

Order multiple is std. pkg.

Cat. no.	Color code	Dimensions (in.)		Dies nos. for 1340	Std. pkg.
		I.D.	O.D.		
Outer rings					
GSC590	Red	0.590	0.670	GS590	50
GSC710	Blue	0.710	0.790	GS710	50
GSC840	Gray	0.840	0.920	GS840	50
GSC1010	Brown	1.010	1.090	GS1010	50
GSC1130	Green	1.130	1.210	GS1130	50
GSC1250	Pink	1.250	1.330	GS1250	50
GSC1440	Purple	1.440	1.520	GS1440	50
GSC1563	Yellow	1.563	1.643	GS1563	50
GSC1670	Red	1.670	1.750	GS1670	5

Order multiple is std. pkg.

Shield-Kon® shield termination system

Hydraulic head installing tool

01 All the two-piece Shield-Kon in the circular range need to be crimped with the 13640 hydraulic head equipped with the appropriate die.

- 3.5-ton nominal pressure (output)
- For two-piece Shield-Kon terminals in the circular range
- Coupling for quick assembly
- Requires a 9,800-psi (approx. 690 bar) operating service pressure
- Quick interchangeable steel dies (to be ordered separately)
- Interlace die with 360° compression – Provides uniform pressure around circumference of connector

Hydraulic head installing tool

Cat. no.	Description	Std. pkg.
13640	Installing head (order dies separately)	1
13606	Hand-foot pump	1
13600	Electric hydraulic pump	1
13620	Hand switch	1
13589A	Foot switch	1
13619	10-ft. non-metallic hydraulic hose	1
13760	Air-operated hydraulic pump	1

Order multiple is std. pkg.



Dragon Tooth[®] magnet wire termination system

Splice, tap and terminate magnet wire quickly and easily!

- 01 Transformer manufacturers depend on Dragon Tooth connectors for reliable magnet wire applications.
- 02 Splice application
- 03 Termination application
- 04 Parallel splice application
- 05 Tap application

Splice, tap and terminate magnet wire quickly and easily!

The tough, high-temperature insulation on magnet wire used by electrical motor and transformer manufacturers creates problems in splicing and terminating. The durability of magnet wire insulation has made dip-soldering or brazing extremely difficult without stripping the insulation.

Another splicing and terminating challenge involves the use of aluminum for magnet applications. A manufacturer connecting aluminum magnet wire to copper is faced with the problem of the different coefficients of thermal expansion of the two metals, galvanic corrosion, cold flow and the rapid formation of oxide film on the wire surface.

ABB offers a solution for a highly reliable connection method for magnet wire. It eliminates welding, no longer requires removal of insulation and it can be installed in seconds. No special operator skills are needed. The connector and matching tooling do the entire job. To meet the essential requirements of magnet wire connections, ABB offers the insulation piercing Dragon Tooth compression connector.

Dragon Tooth magnet wire connectors

Dragon Tooth connectors and installing tools are designed to splice, tap and terminate magnet wire from #32 AWG to 460,000 CMA copper and from #18 AWG to 460,000 CMA aluminum conductors in motor and transformer applications. Dragon Tooth magnet wire connectors penetrate the insulation and oxide layers to make electrical contact on magnet wiring. The result is permanent, low-resistance electrical connections, capable of maintaining contact integrity throughout the life of the connection.

- Designed to penetrate magnet wire insulation during application, eliminating the need for stripping, brazing, welding or other methods of joining magnet wire
- Can be installed in seconds
- Requires minimal training for installation
- Made of copper alloy, tin plated, with teeth on the inner surface
- Splices and taps have an open side enabling easy access to wire and making internal coil tapping possible
- For aluminum to copper, aluminum to aluminum or copper to copper magnet wire connections
- Supplied with bolt holes to accommodate #6 through ½" studs and includes male and female 0.250" x 0.032" disconnects
- Rings and fork terminals accommodate wire sizes #24 to #12 AWG in a variety of combinations, including combining magnet wire with stripped wire lead. For solid or stranded wire #20 to 4/0 AWG
- Larger connectors accommodate circular mil range from 50,000 to 460,000 CMA
- Connector and matching tooling do the entire job

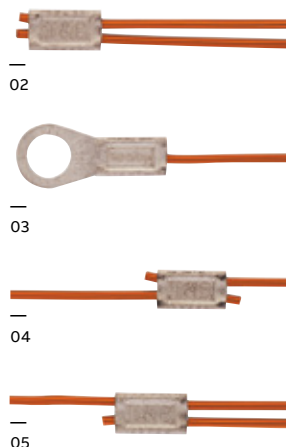

Dragon Tooth[®] magnet wire termination system



Dragon Tooth connectors transform the perpendicular compression force, which would normally contribute to conductor creep, into distributive forces that effectively resist cold flow, as indicated by the illustration below.



These connectors are made of copper alloy, tin plated, with a number of teeth on the inner surface. When compressed onto an insulated magnet wire, the sharp, hardened teeth penetrate both the insulation and oxide and bite into the conductor. An electrically sound, low-resistance connection is established as a result of the combination of high pressures at the edges of the teeth, and the sliding action between the teeth and the conductor. The open barrel design permits midspan splicing and tapping.

How to select a connector

- 1) Determine total circular mil area (CMA).
All wires to be installed in a connector barrel including stripped, stranded wire.
For example, two #6 AWG = 52,480 CMA.
- 2) Refer to circular mil column of chart and find the connector series corresponding to the total CMA. For example, 204XXX.
- 3) Next, refer to either round wire column or rectangular wire column, depending on the type you are using, and check for any limitations, (such as max. wire width/height). If there are limitations, you may have to make a selection from the next larger size.
- 4) Select the tool and die appropriate for the application.

Formula for calculating circular mil area (CMA)

For square or rectangular wire:

$$\text{Thickness} \times \text{width} \times 1.273 \times 10^6 = \text{CMA}$$

For round wire:

$$\text{Diameter}^2 \times 10^6 = \text{CMA (or see chart on p. 128)}$$

For wire sizes and combinations other than shown, contact ABB technical services at 888-862-3289.

These connectors are made of copper alloy, tin plated, with a number of teeth on the inner surface. When the connector is compressed onto an insulated magnet wire, the sharp, hardened teeth penetrate the insulation and the oxide and bite into the conductor. An electrically sound, low-resistance connection is established as a result of the combination of high pressures at the tip and edges of the teeth, and the sliding action between the teeth and the conductor.

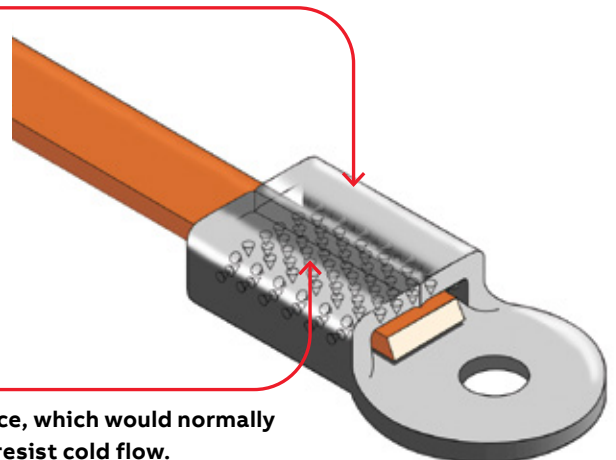

Dragon Tooth connectors transform the perpendicular compression force, which would normally contribute to conductor creep, into distributive forces that effectively resist cold flow.

Dragon Tooth® magnet wire termination system



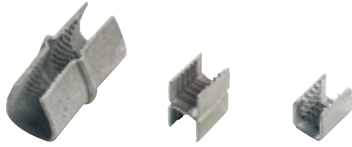



Splices

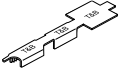

Splices for copper and aluminum magnet wire!

- Penetrate all standard copper and aluminum magnet wire insulations
- Perfect for heavy Formvar, poly-thermaleze, polyester and polyurethane insulations
- For special insulations, consult technical services.

Splices

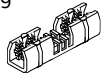
	Cat. no.	Dimensions (in.)				Circular mil area	Round wire range (AWG) min.-max.	Rectangular wire range (in.)		Pkg. qty.
		A	B	C	D*			Thickness	Width	
1 	214420	0.43	0.25	0.22	0.135	–	21 (4)–13 (2)	–	–	1000
2 	220004	0.17	0.11	0.08	0.03	468–1,724	32–24**	–	–	8400†
	220001	0.34	0.17	0.14	0.09	1,277–4,205	26–17**	0.02–0.04	0.02–0.09	3000†
	220002–TB	0.34	0.25	0.18	0.09	2,985–6,687	24–14**	0.02–0.05	0.02–0.10	3000†
	220006	0.47	0.25	0.19	0.09	5,162–12,330	16–12	0.05–0.08	0.05–0.16	2500†
3 	22L004	0.15	0.11	0.09	0.03	128–2,028	32–24**	–	–	1000
	22L001	0.32	0.16	0.16	0.10	808–5,162	26–17**	0.02–0.04	0.02–0.10	1000
	22L002	0.32	0.25	0.19	0.10	2,048–9,110	24–15**	0.02–0.05	0.02–0.11	1000
	22L006	0.44	0.25	0.22	0.13	2,580–12,330	16–12	0.05–0.08	0.05–0.16	1000
	22L008	0.70	0.50	0.35	0.13	12,960–30,550	18–14	0.04–0.06	0.06–0.38	100
	22L009	0.70	0.55	0.46	0.20	36,120–86,000	16–5	0.08–0.18	0.08–0.38	100
	22L010	0.70	0.78	0.71	0.22	69,750–173,090 (f)	–	0.10–0.23 (Cu) 0.10–0.18 (Al)	0.30–0.63	50
4 	210214S	0.63	0.38	0.37	0.17	4,110–20,760	14(a)–10	0.08–0.09	0.08–0.18	250
	204210S	0.69	0.53	0.53	0.25	10,380–52,480	12(b)–4(e)	0.10–0.16	0.10–0.26	100
5 	204210SH	0.69	0.53	1.05	0.48	20,760–104,960	12(c)–2(d)	0.10–0.16	0.10–0.26	100
6 	22L009H	0.70	0.55	0.93	0.37	72,000–132,000	16–5	0.08–0.18	0.08–0.38	100
7 	220015	1.50	0.88	0.77	(e)	50,000–115,000	10–6	0.100–0.175	0.300–0.625	50
	220019	1.50	0.88	0.85	(e)	110,000–175,000	6–2	0.175–0.250	0.300–0.625	25
	220023	1.75	0.88	0.93	(e)	165,000–230,000	2–1/0	0.250–0.325	0.300–0.625	25
8 	314118S	0.63	0.38	0.30	0.14	3,260–12,330	15–13	0.05–0.06	0.05–0.18	250
9 	220016	3.13	0.88	0.77	(e)	50,000–115,000	10–6	0.100–0.175	0.300–0.625	25
	220020	3.13	0.88	0.85	(e)	110,000–175,000	6–2	0.175–0.250	0.300–0.625	25
	220024	3.63	0.88	0.93	(e)	165,000–230,000	2–1/0	0.250–0.325	0.300–0.625	25

Diagrams

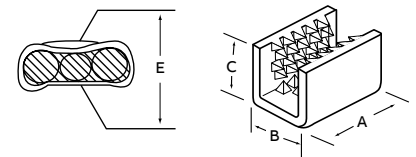

* Reference dimension. See installing die illustration for gauging. ** Not recommended for aluminum magnet wire finer than 21 gauge. (a) Four wires max. (b) Six wires max. (c) Six wires max. each barrel. (d) Conductors heavier than #6 AWG require special dies. Contact ABB for assistance. (e) Crimping dies may not bottom. Connector height will depend on number and size of wires in barrel. Pump must deliver 9800 psi minimum. (f) Copper CMA, aluminum CMA=52,136–124,561. † On a reel. Note: Wire sizes and combinations shown have been tested to and meet or exceed ABB specifications. Connectors may be suitable for other wire sizes or combinations. ABB sells these connectors with the understanding that the user will perform necessary tests to determine their suitability for the intended purpose.

Dragon Tooth® magnet wire termination system

Splices (continued)

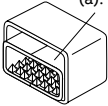
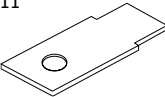
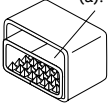
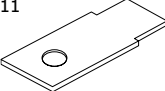

Splices

Cat. no.	Stud size (in.)	Dimensions (in.)					Circular mil area	Round wire range (AWG)	Rectangular wire range (in.)		Pkg. qty.	
		A	B	C	D	E			Thickness	Width		
10 See Note (a). 	210214MT	-	0.63	0.63	0.75	0.25	0.19*	20,000-105,000	5-13	Lower half	250	
										0.08-0.15		0.08-0.49
												Upper half
										0.25 max.	0.75 max.	
11 	210MT14	1/4	1.00	1.44	0.81	-	0.08		5-13	For conn	25	
	210MT38	3/8	1.00	1.44	0.81	-	0.08		5-13	210214MT	25	
10 See Note (a). 	204210MT	-	0.92	0.94	1.03	0.25	0.25*	90,000-215,000	3-10	Lower half	100	
										0.10-0.25		0.10-0.92
												Upper half
										0.25 max.	1.03 max.	
11 	204MT14	1/4	1.00	1.44	0.91	-	0.10		3-10	For conn	25	
	204MT38	3/8	1.00	1.44	0.91	-	0.10		3-10	204210MT	25	

Diagrams

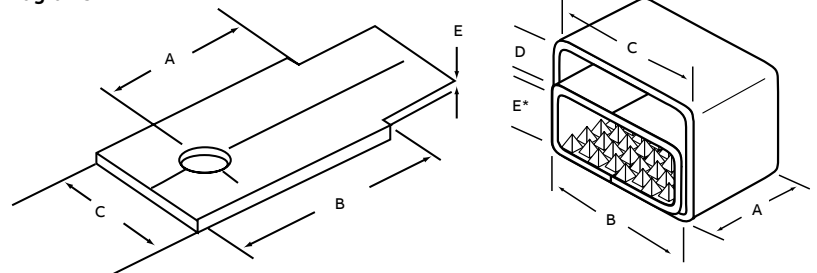

(a) This space may be used for terminal tongue insert, stripped stranded copper wire, stripped copper magnet wire or left empty.
* Between teeth.

Note: Wire sizes and combinations shown have been tested to and meet or exceed ABB specifications. Connectors may be suitable for other wire sizes or combinations. ABB sells these connectors with the understanding that the user will perform necessary tests to determine their suitability for the intended purpose.

Dragon Tooth® magnet wire termination system

Ring terminals



Secure connections easily!

Ring terminals

	Cat. no.	Stud size (in.)	Dimensions (in.)					Circular mil area	Round wire range (AWG)	Rectangular wire range (in.)		Pkg. qty.	
			A	B	C	D	E*			Thickness	Width		
	1	314125	10	0.38	0.56	1.22	0.41	0.14	3,260–12,330	15–13	0.05–0.06	0.05–0.18	250
		314123	1/4"	0.38	0.56	1.41	0.41	0.14	3,260–12,330	15–13	0.05–0.06	0.05–0.18	250
		210219	8	0.38	0.56	1.22	0.41	0.17	4,110–20,760	14(a)–10	0.08–0.09	0.08–0.18	250
		210217	10	0.38	0.56	1.22	0.41	0.17	4,110–20,760	14(a)–10	0.08–0.09	0.08–0.18	250
		210216	1/4	0.38	0.56	1.41	0.41	0.17	4,110–20,760	14(a)–10	0.08–0.09	0.08–0.18	250
		204217	10	0.53	0.61	1.58	0.50	0.25	10,380–52,480	12(b)–4(c)	0.10–0.16	0.10–0.26	100
		204212	1/4	0.53	0.61	1.58	0.50	0.25	10,380–52,480	12(b)–4(c)	0.10–0.16	0.10–0.26	100
	2	210214–1	1/4	0.38	0.56	1.41	0.69	0.17	4,110–20,760	14(a)–10	0.08–0.09	0.08–0.18	250
		210214–2	5/16	0.38	0.56	1.41	0.69	0.17	4,110–20,760	14(a)–10	0.08–0.09	0.08–0.18	250
		210214–3	3/8	0.38	0.56	1.41	0.69	0.17	4,110–20,760	14(a)–10	0.08–0.09	0.08–0.18	250
		204210–1	1/4	0.53	0.61	1.58	0.81	0.25	10,380–52,480	12(b)–4(c)	0.10–0.16	0.10–0.26	100
		204210–2	5/16	0.53	0.61	1.58	0.81	0.25	10,380–52,480	12(b)–4(c)	0.10–0.16	0.10–0.26	100
		204210–3	3/8	0.53	0.61	1.58	0.81	0.25	10,380–52,480	12(b)–4(c)	0.10–0.16	0.10–0.26	100
		204210–5	1/2	0.53	0.61	1.58	0.81	0.25	10,380–52,480	12(b)–4(c)	0.10–0.16	0.10–0.26	100
	3	204210–1H	1/4	0.53	0.61	1.58	0.81	0.47	20,760–104,960	12(b)–4(c)	0.10–0.16	0.10–0.26	100
		204210–3H	3/8	0.53	0.61	1.58	0.81	0.47	20,760–104,960	12(b)–4(c)	0.10–0.16	0.10–0.26	100
	4	220017	3/8	0.88	1.50	2.76	1.06	(d)	50,000–115,000	0.100–0.175	–	0.300–0.625	25
		220018	1/2	0.88	1.50	2.76	1.06	(d)	50,000–115,000	0.100–0.175	–	0.300–0.625	25
		220021	3/8	0.88	1.50	2.76	1.06	(d)	110,000–175,000	–	0.175–0.250	0.300–0.625	25
		220022	1/2	0.88	1.50	2.76	1.06	(d)	110,000–175,000	–	0.175–0.250	0.300–0.625	25
		220025	3/8	0.88	1.50	2.76	1.06	(d)	110,000–230,000	–	0.175–0.325	0.300–0.625	25
		220026	1/2	0.88	1.50	2.76	1.06	(d)	110,000–230,000	–	0.175–0.325	0.300–0.625	25
		5	22R061**	6	0.16	0.32	0.78	0.30	0.10	404–4100	15–24	0.02–0.05	0.02–0.10
		22R081**	8	0.16	0.32	0.78	0.30	0.10	404–4100	15–24	0.02–0.05	0.02–0.10	1000
		22R101**	10	0.16	0.32	0.78	0.30	0.10	404–4100	15–24	0.02–0.05	0.02–0.10	1000
		22R086	8	0.25	0.45	0.91	0.30	0.13	2,580–12,330	12–16	0.05–0.08	0.05–0.16	1000
		22R106	10	0.25	0.45	0.91	0.30	0.13	2,580–12,330	12–16	0.05–0.08	0.05–0.16	1000
		6	22R146	1/4	0.25	0.45	0.95	0.42	0.13	2,580–12,330	12–16	0.05–0.08	0.05–0.16

Diagrams

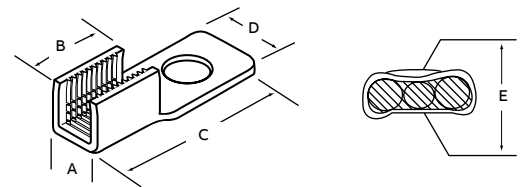

* Reference dimension. See installing die illustration for gauging. (a) Four wires max. (b) Six wires max. (c) Conductors heavier than #6 AWG require special dies. Contact ABB for assistance. (d) Crimping dies may not bottom. Connector height will depend on number and size of wires in barrel. Pump must deliver 9800 psi minimum.

Note: Wire sizes and combinations shown have been tested to and meet or exceed ABB specifications. Connectors may be suitable for other wire sizes or combinations. ABB sells these connectors with the understanding that the user will perform necessary tests to determine their suitability for the intended purpose.

** #22–#24 AWG and equivalent rectangular CMA, copper only.

Dragon Tooth® magnet wire termination system

Fork terminals and disconnects



Connectors for every application!

Fork terminals

	Cat. no.	Stud size (in.)	Dimensions (in.)					Circular mil area	Round wire range (AWG)	Rectangular wire range (in.)		Pkg. qty.
			A	B	C	D	E*			Thickness	Width	
1	22F061**	6	0.16	0.32	0.78	0.30	0.10	404-4100	15-24	0.02-0.05	0.02-0.10	1000
	22F081**	8	0.16	0.32	0.78	0.30	0.10	404-4100	15-24	0.02-0.05	0.02-0.10	1000
	22F101**	10	0.16	0.32	0.78	0.30	0.10	404-4100	15-24	0.02-0.05	0.02-0.10	1000
	22F066	6	0.25	0.45	0.91	0.30	0.13	2,580-12,330	12-16	0.05-0.08	0.05-0.16	1000
	22F086	8	0.25	0.45	0.91	0.30	0.13	2,580-12,330	12-16	0.05-0.08	0.05-0.16	1000
	22F106	10	0.25	0.45	0.91	0.30	0.13	2,580-12,330	12-16	0.05-0.08	0.05-0.16	1000
2	210219F	6	0.25	0.45	0.91	0.30	0.13	2,580-12,330	12-16	0.05-0.08	0.05-0.16	1000
	210217F	8	0.25	0.45	0.91	0.30	0.13	2,580-12,330	12-16	0.05-0.08	0.05-0.16	1000
	210216F	10	0.25	0.45	0.91	0.30	0.13	2,580-12,330	12-16	0.05-0.08	0.05-0.16	1000

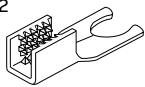
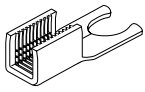

Diagrams

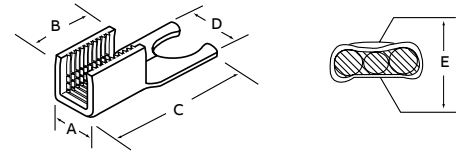

* Reference dimension. See installing die illustration for gauging.

** #22-#24 AWG and equivalent rectangular CMA, copper only.



Durable and convenient!

Disconnects

	Cat. no.	Tab size (in.)	Dimensions (in.)					Circular mil area	Round wire range (AWG)	Rectangular wire range (in.)		Pkg. qty.
			A	B	C	D	E*			Thickness	Width	
1	22LM01**	0.250 x 0.032	0.16	0.32	0.76	0.25	0.10	404-4100	15-24	0.02-0.05	0.02-0.10	1000
	22LM06	0.250 x 0.032	0.25	0.45	0.91	0.25	0.13	2,580-12,330	12-16	0.05-0.08	0.05-0.16	1000
2	22LF01**	0.250 x 0.032	0.16	0.32	0.79	0.25	0.10	404-4100	15-24	0.02-0.05	0.02-0.10	1000
	22LF06	0.250 x 0.032	0.25	0.45	0.91	0.25	0.13	2,580-12,330	12-16	0.05-0.08	0.05-0.16	1000

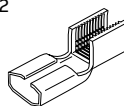
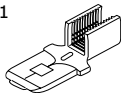

Diagrams



* Reference dimension. See installing die illustration for gauging.

Note: Wire sizes and combinations shown have been tested to and meet or exceed ABB specifications. Connectors may be suitable for other wire sizes or combinations. ABB sells these connectors with the understanding that the user will perform necessary tests to determine their suitability for the intended purpose.

** #22-#24 AWG and equivalent rectangular CMA, copper only.

Dragon Tooth® magnet wire termination system

Taps and washers



Quick and easy connections!

Taps

Cat. no.	Stud size (in.)	Dimensions (in.)					Circular mil area	Rectangular wire range (in.)		Pkg. qty.
		A	B	C	D	E*		Thickness	Width	
204T14	1/4	1.62	1.22	0.70	0.50	0.22	10,310–52,480	0.090–0.114	0.090–0.320	100
204T38	3/8	1.62	1.22	0.70	0.50	0.22	10,310–52,480	0.090–0.114	0.090–0.320	100

Diagram

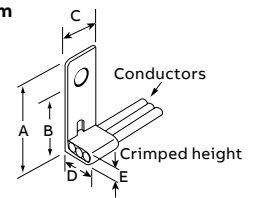

* Reference dimension. See installing die illustration for gauging.



Copper to aluminum connections!

- Teeth on the transition washers penetrate aluminum and copper oxides
- Enables copper to aluminum connections to be made in a bolted joint without the use of inhibiting compounds
- Accommodates the difference in thermal expansion between copper and aluminum, and enhances the efficiency of bolted grounding connections

Washers

Cat. no.	Bolt size (in.)	Dimensions (in.)		Recommended installing torque in.-lbs.	Pkg. qty.
		A	B		
FPW14	1/4	0.27	0.68	50–80	250
FPW516	5/16	0.34	1.00	125–160	250
FPW38	3/8	0.43	1.00	160–240	250
FPW12	1/2	0.56	1.25	390–540	250
FPW58	5/8	0.68	1.40	540–730	250

Diagrams

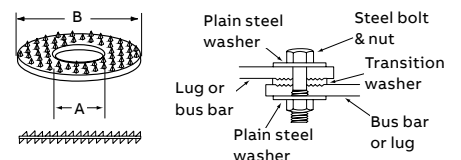

Note: Wire sizes and combinations shown have been tested to and meet or exceed ABB specifications. Connectors may be suitable for other wire sizes or combinations. ABB sells these connectors with the understanding that the user will perform necessary tests to determine their suitability for the intended purpose.

Dragon Tooth® magnet wire termination system

Conversion of AWG to circular mils and decimal equivalents

Additional magnet wire ordering information

- 1) For wire sizes and combinations other than shown, consult factory.
- 2) Maximum of two layers of conductors in each connector.
- 3) Consult factory for gauging other than shown.
- 4) When terminating wires with an AWG size difference of four or more, samples should be tested in completed connections before using.

Conversion of AWG to circular mils

Wire size AWG	Nom. diameter		Circular mils
	(in.)	(mm)	
4/0	0.4600	11.68	211,600
3/0	0.4096	11.40	167,800
2/0	0.3648	9.266	133,100
1/0	0.3249	08.52	105,600
1	0.2893	7.348	83,690
2	0.2576	6.543	66,360
3	0.2294	5.827	52,620
4	0.2043	5.189	41,740
5	0.1819	4.620	33,090
6	0.1620	4.115	26,240
7	0.1443	3.665	20,820
8	0.1285	3.264	16,510
9	0.1144	2.906	13,090
10	0.1019	2.588	10,380
11	0.0907	2.30	8230
12	0.0808	2.05	6530
13	0.0720	1.83	5180
14	0.0641	1.63	4110
15	0.0571	1.45	3260
16	0.0508	1.29	2580
17	0.0453	1.15	2050
18	0.0403	1.02	1620
19	0.0359	0.912	1290
20	0.032	0.813	1020
21	0.0285	0.724	812
22	0.0253	0.643	640
23	0.0226	0.574	511
24	0.0201	0.511	404

Decimal equivalents

Wire size AWG	Nom. diameter		Circular mils
	(in.)	(mm)	
1/64	0.0156	3/16	0.1875
1/32	0.0312	13/64	0.2031
3/64	0.0469	7/32	0.2188
1/16	0.0625	15/64	0.2344
5/64	0.0784	1/4	0.25
3/32	0.0938	–	–
7/64	0.1094	17/64	0.2656
1/8	0.125	9/32	0.2812
9/64	0.1406	19/64	0.2969
5/32	0.1562	5/16	0.3125
11/64	0.1719	211/64	0.3281
11/32	0.3438	33/64	0.5156
23/64	0.3594	17/32	0.5312
3/8	0.375	35/64	0.5469
25/64	0.3906	9/16	0.5625
13/32	0.4062	37/64	0.5781
27/64	0.4219	19/32	0.5938
7/16	0.4375	39/64	0.6094
29/64	0.4531	5/8	0.625
15.32	0.4688	41/64	0.6406
31/64	0.4844	21/32	0.6562
1/2	0.5	43/64	0.6719

Note: Multiply inches x 25.4 to get millimeters.
Example: .5" x 25.4 = 12.7 mm.

Stud size (in.)	#6	#8	#10	3/4"	5/16"	3/8"	1/2"
Hole Dia. (in.)	0.143	0.169	0.196	0.260	0.323	0.386	0.516

Dragon Tooth® magnet wire termination system

Ergonomic manual installation tools



- Fixed die tool
- Incorporates the ergonomically designed Comfort Crimp® tool handles, which distribute the force more evenly across the hand
- Shure-Stake® mechanism ensures a complete crimp cycle before the tool releases
- Rubberized thermoplastic handles combine maximum friction with a soft, comfortable feel that reduces muscle tension
- Two-piece movable die nest provides easy connector removal (ERG811 has a fixed die nest)
- Crimp with comfort!

Ergonomic manual installation tools

Cat. no.	Tool gauging (in.)	Connector	Pkg. qty.
ERG1801	0.069 max.	22F, L, R-1 Series	1
ERG1802	0.076 max.	22L002	1
ERG1804	0.034 max.	22L004	1
ERG1806	0.095 max.	22F, L, R-6 Series	1
ERG811	0.103 max.	214420	1

Contact customer services for availability and most recent additions to the ergonomic tool series.

ABB tool warranty

You can choose ABB tools with confidence, because we stand behind them with our warranty. The chart below shows the standard length of warranty for different types of tools. See below for additional warranty details.

ABB tool warranty

90 Days	1 Year	2 Years	Lifetime
Batteries	Pneumatic tools	Mechanical hand tools with ratchet or Shure-Stake mechanism	Mechanical hand tools without ratchet or Shure-Stake mechanism
Individual dies	Cable cutters & strippers	Hydraulic pumps	
Duct tools	Ty-Rap® tools	Battery-operated tools	
		Manual hydraulic tools	

Limited warranty for tools

ABB sells tools with the understanding that the user will perform all necessary tests to determine the suitability of each tool for the user's intended application. ABB warrants that its tools will be free from defects in materials and workmanship for the period of time specified above. Upon prompt notification of any warranted defect, ABB will, at its option, repair or replace the defective product or refund the purchase price. Proof of purchase is required. Misuse or unauthorized modification of the product voids all warranties.

Limitations and exclusions

The warranty above is the sole warranty concerning this product, and is in lieu of all other warranties expressed or implied, including but not limited

to any implied warranty of merchantability or fitness for a particular purpose, which are specifically disclaimed. Liability for breach of the above warranty is limited to cost of repair or replacement of the product, and under no circumstances will ABB be liable for any indirect, special, incidental or consequential damages.

Direct all warranty inquiries to ABB tool services: 1-800-284-TOOL (8665).

Replacement batteries and chargers

can be purchased from ABB Tool Services:

Call Toll-Free 1-800-284-TOOL (8665)

For more information about ABB Tool Services:

E-mail us at toolservice@tnb.com

Dragon Tooth® magnet wire termination system

Battery-powered crimping tool – BAT22-6



ABB's newest battery-powered tool is fast and portable for making high-volume and difficult-to-reach terminal installations in a snap. The BAT22-6 delivers 1.5 tons of crimping force with an easy, pushbutton trigger. The lightweight, ergonomic design minimizes the risk of repetitive motion injuries that can occur with traditional hand crimping tools. And at less than three pounds, one-hand operation is easy while still packing enough power to crimp up to #6 AWG terminals in seconds.

- Interchangeable dies can be quickly changed to crimp non-insulated and insulated terminals up to #6 AWG
- Dies are the same as our hand tools – Crimps will be exactly the same between Dragon Tooth hand tools such as our ERG1804 and the BAT22-6
- 360° rotating head gives the user the added flexibility when crimping hard-to-reach connections
- Short cycle time equates to crimping times of less than two seconds
- Quick, lightweight and maneuverable
- NiCd battery operation provides long-lasting battery life to complete up to 150 crimps on a single charge
- Extra battery and charger are included with the tool, ensuring round-the-clock operation
- Battery charger provides full battery life in under an hour
- Linear crimping motion gives a symmetric, high-quality crimp every time

01 Easy to rotate with your wrist – Delivers fast and effective crimping power.

02 Uses the exact dies of the Comfort Crimp® line of ergonomic tools for Sta-Kon® and Dragon Tooth connectors.



01



02

1½ tons of grip that weighs less than three pounds!

Included accessories

- Sturdy, plastic carrying case for portability
- Two 9.6V NiCd batteries and battery charger
- Sturdy tray for convenient storage of crimp dies

Specifications

- Crimping Force: 2,900 lbs. max.
- Wire crimping range: up to #6 AWG
- Crimp cycle time: 2 seconds
- Power supply: 9.6 V NiCd battery
- Recharging time: 1 hour
- Crimps per charge: 150
- Dimensions:
 - 25.4" (645 mm) length
 - 3.1" (79 mm) width
 - 2.1" (53 mm) height
- Tool weight (with battery): 2¾ lbs.

Battery-powered crimping tool – BAT22-6

Cat. no.	Description	Pkg. qty.
BAT22-6	Battery crimping tool 1.5 ton with 120 V AC charger	1
Crimp dies*		
DIE1801	22 F, L, R-1 series	1
DIE1802	22L002	1
DIE1804	22L004	1
DIE1806	22 F,L,R-6 series	1

Tool purchase includes crimping tool, two 9 V batteries, charger and case.

* Dies sold separately.

Dragon Tooth® magnet wire termination system

Heavy-duty air crimp tools



BAIR22-6 – Heavy-duty bench-top air crimp tool

Perfect for high-speed installation!

- Bench mounted for stability and operator control
- Compact size, all-metallic construction
- Delivers 1.8 tons of crimping force at 100 psi
- Heavy-duty and installs wide range of Dragon Tooth connectors

Specifications

- Height: 12"
- Operating pressure: 85–100 psi
- Base: 8" square
- Weight: 17 lbs.

Cat. no.	Description
BAIR22-6	Equipped with Shure-Stake® mechanism, ensuring full crimp cycle before release



PAIR22-6 – Heavy-duty portable air crimp tool

Pneumatic power!

- Installs Dragon Tooth® terminals
- Hand actuated
- Delivers 1.25 tons of crimping force at 100 psi
- Three interchangeable dies can crimp the 22xxx1, 22xxx2, 22xxx4 and 22xxx6 series terminals

Specifications

- Overall length: 14"
- Diameter: 2¼"
- Operating pressure: 90–100 psi
- Weight: 2.5 lbs.

Cat. no.	Description
PAIR22-6	Open "C" yoke; hand actuated

Installing dies for BAIR22-6 and PAIR22-6

Cat. no.	Description	Pkg. qty.
Crimp dies		
DIE1801	22 F, L, R-1 series	1
DIE1802	22L002	1
DIE1804	22L004	1
DIE1806	22 F,L,R-6 series	1

Dragon tooth® magnet wire termination system

6-ton hydraulic head and 12-ton crimping tool



Rugged and portable!

- Lightweight design – Weighs less than 7 lbs. including dies
- Includes steel carrying case
- Tool carrying case included
- Dies are ordered as a set (two pieces)

Specifications

- Output force: 6 tons nominal
- Operating pressure: 10,000 psi nominal
- Tool weight: 6½ lbs. (Without dies)
- Tool dimensions: 13½" long, 3½" wide

6-ton hydraulic head

Cat. no.	Description
TBM6H	The TBM6H remote hydraulic crimping head is a lightweight but powerful compression tool. The TBM6H operates from any 10,000-psi hydraulic pump.

See die chart on page 135-136 for complete listing of dies and connectors used with TBM6H.



Military listed and 12 tons of crimping power!

12-ton crimping tool (Military Spec. MS25441-1)

Cat. no.	Description	Pkg. qty.
13642M	Hydraulic-operated 12-ton tool installs #8 AWG through 250 kcmil Sta-Kon® terminals (dies ordered separately)	1

See die chart on page 135-136 for complete listing of dies and connectors used with 13642M.

Dragon tooth® magnet wire termination system

Type WASC-CF and 14-ton hydraulic head



Powerful and reliable!

- 12-ton hydraulic head
- 12 tons output (nominal)
- 10,000 psi max. hydraulic operating pressure
- Weighs 15 lbs.

Specifications

- Output: 12 tons (nominal)
- Hydraulic operating pressure: 10,000 psi (max.)
- Length (with coupling): 14½"
- Width: 3¼"
- Weight (without dies): 15 lbs.

Type WASC-CF – Weld spherical coupler, pipe to pipe

Cat. no.	Description	Pkg. Qty.
13400	12-ton crimping tool supplied with adapter TBM12D-AR is used for installing both insulated and non-insulated Sta-Kon® terminals #8 AWG to 250 kcmil (dies ordered separately)	1

Diagram

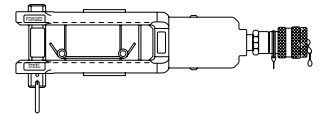

See die chart on page 135-136 for complete listing of dies and connectors used with 13400.



Lightweight design!

- 14 tons output (nominal)
- 10,000-psi max. hydraulic operating pressure
- Weighs 10 lbs.

Specifications

- Output: 14 tons (nominal)
- Hydraulic operating pressure: 10,000 psi (max.)
- Length (with coupling): 11½"
- Width: 2½"
- Height: 4¼"
- Weight (without dies): 10 lbs.

14-ton hydraulic head

Cat. no.	Description	Pkg. qty
13100A	Remote 14-ton hydraulic head (dies ordered separately)	1

See die chart on page 135-136 for complete listing of dies and connectors used with 13100A.

Dragon tooth® magnet wire termination system

15-ton hydraulic head and electric hydraulic pumps



Crimp larger connectors easily!

- Longer, slimmer profile enables easier access into tight spaces
- Wider jaw opening eases crimping of larger connectors
- Head made of forged steel and insulated with rubber boot
- Steel carrying case is included

Specifications

- Output force: 15 tons nominal
- Operating pressure: 10,000 psi nominal
- Tool weight: 16½ lbs. (without dies)
- Installs:
 - #8 AWG–1500 kcmil copper; #10 AWG–1000 kcmil aluminum

15-ton hydraulic head

Cat. no.	Description	Pkg. qty.
TBM15I	Insulated 15-ton hydraulic tool; carrying case included	1

See die chart on page 135-136 for complete listing of dies and connectors used with TBM15I.

01 13810

02 13610A

- Up to 10,000-psi output pressure
- Durable construction
- Hand or foot actuated

Electric hydraulic pumps

Cat. no.	Description
13810	Heavy-duty electric hydraulic pump with Shure-Stake® control – Hand or foot switch and non-metallic hose (sold separately) required for operation

You may also need...

13611	Hand switch
13612	Foot switch
13613	High pressure, steel reinforced hydraulic hose; 6 ft.
13614	High pressure, steel reinforced hydraulic hose; 10 ft.
13619	High pressure, plastic hydraulic hose; 10 ft.
13600	Electric hydraulic pump – Hand or foot switch and non-metallic hose (sold separately) required for operation

You may also need...

13620	Hand switch
13589A	Foot switch
13619	10-ft. non-metallic hose
13618	20-ft. non-metallic hose

A remote control switch is required. Order Cat. No. 13620 for hand operation or Cat. No. 13589A for foot operation. All pumps are supplied with a metal carrying case.

13610A	Shure-Stake electric hydraulic pump has same features as 13600, but includes the Shure-Stake control mechanism; hand or foot switch and non-metallic hose (sold separately) required for operation
--------	--

You may also need...

13611	Hand switch
13612	Foot switch
13797	In-line hydraulic pressure inspection gauge with male and female pioneer-type coupler.

A remote control switch is required to operate this unit. Use either a 13611 (hand) or 13612 (foot) switch.



01



02

Dragon tooth® magnet wire termination system

An easy-to-use reference guide for tools and connectors!

Connector	Manual	BAT 22-6 BAIR 22-6 PAIR 22-6	TBM6H	13100A	13400 13642M	TBM15I
DIES						
204210MT	-	-	-	-	13682	-
204210S	-	-	-	13671B	13671A	13671B with 15500TB
204210SH	-	-	-	13673B	13673	13673B with 15500TB
204210-1	-	-	-	13671B	13671A	13671B with 15500TB
204210-1H	-	-	-	13673B	13673	13673B with 15500TB
204210-2	-	-	-	13671B	13671A	13671B with 15500TB
204210-3	-	-	-	13671B	13671A	13671B with 15500TB
204210-3H	-	-	-	13673B	13673	13673B with 15500TB
204210-5	-	-	-	13671B	13671A	13671B with 15500TB
204212	-	-	-	13671B	13671	13671B with 15500TB
204217	-	-	-	13671B	13671A	13671B with 15500TB
204MT14	-	-	-	-	-	-
204MT38	-	-	-	-	-	-
204T14	-	-	-	13689B	-	13689B with 15500TB
204T38	-	-	-	13689B	-	13689B with 15500TB
210214MT	-	-	-	13681B	13681	13681B with 15500TB
210214S	-	-	-	13670B	13670A	13670B with 15500TB
210214-2	-	-	-	13670B	13670A	13670B with 15500TB
210214-3	-	-	-	13670B	13670A	13670B with 15500TB
210216, 210216F	-	-	-	13670B	13670A	13670B with 15500TB
210217, 210217F	-	-	-	13670B	13670A	13670B with 15500TB
210219, 210219F	-	-	-	13670B	13670A	13670B with 15500TB
210MT14	-	-	-	-	-	-
210MT38	-	-	-	-	-	-
214420	ERG811/WT811	DIE 811	-	-	-	-
220001	-	-	-	-	-	-
220002-TB	-	-	-	-	-	-
220004	-	-	-	-	-	-
220005	-	-	-	-	-	-
220006	-	-	-	-	-	-
220015	-	-	-	13713B	-	13713
220016	-	-	-	13713B	-	13713
220017	-	-	-	13713B	-	13713
220018	-	-	-	13713B	-	13713
220019	-	-	-	13713B	-	13713
220020	-	-	-	13713B	-	13713
220021	-	-	-	13713B	-	13713
220022	-	-	-	13713B	-	13713
220023	-	-	-	13713B	-	13713
220024	-	-	-	13713B	-	13713
220025	-	-	-	13713B	-	13713
220026	-	-	-	13713B	-	13713
22F061	ERG1801	DIE1801	-	-	-	-
22F066	ERG1806	DIE1806	-	-	-	-
22F081	ERG1801	DIE1801	-	-	-	-
22F086	ERG1806	DIE1806	-	-	-	-

Note: Dies that fit 13100A also work in TBM15I with use of adapter 15500TB.

(Continued on next page)

Dragon tooth® magnet wire termination system

An easy-to-use reference guide for tools and connectors! (continued)

Connector	Manual	BAT 22-6 BAIR 22-6 PAIR 22-6	TBM6H	13100A	13400 13642M	TBM15I
	Dies					
22F101	ERG1801	DIE1801	-	-	-	-
22F106	ERG1806	DIE1806	-	-	-	-
22L001	ERG1801	DIE1801	-	-	-	-
22L002	ERG1802	DIE1802	-	-	-	-
22L004	ERG1804	DIE1804	-	-	-	-
22L006	ERG1806	DIE1806	-	-	-	-
22L008	-	-	6TON-MW-08	13683B	13683	13683B with 15500TB
22L009	-	-	6TON-MW-09	13684B	13684	13684B with 15500TB
22L009H	-	-	-	13686B	13686	13686B with 15500TB
22L010	-	-	-	13690B	-	-
22LF01	ERG1801	DIE1801	-	-	-	-
22LF06	ERG1806	DIE1806	-	-	-	-
22LM01	ERG1801	DIE1801	-	-	-	-
22LM06	ERG1806	DIE1806	-	-	-	-
22R061	ERG1801	DIE1801	-	-	-	-
22R106	ERG1806	DIE1806	-	-	-	-
22R146	ERG1806	DIE1806	-	-	-	-
314118S	-	-	-	13685B	13685	13685B with 15500TB
314123	-	-	-	13685B	13685	13685B with 15500TB
314125	-	-	-	13685B	13685	13685B with 15500TB

Note: Dies that fit 13100A also work in TBM15I with use of adapter 15500TB.

Appendix

Part number index

Cat. no.	Page	Cat. no.	Page	Cat. no.	Page	Cat. no.	Page
10RC-10	12	11784M	64	13642M	63, 132	14RB-8FLX	26
10RC-10CP	52	11785M	64	13643	65	14RB-8FX	25
10RC-10F	24	11786M	64	13644	65	14RB-8X	13
10RC-10FCP	52	11787M	64	13645	65	14RBC-10	18
10RC-10FL	25	11788M	64	13650	65	14RBC-12	18
10RC-10FLX	26	11789M	64	13654	65	14RBC-14	18
10RC-10FX	25	11802	58	13655	65	14RBC-38	18
10RC-10X	13	11803	58	13656	65	14RBC-516	18
10RC-14	12	11805	58	13657	65	14RBC-6	18
10RC-14CP	52	11806	58	13658	65	14RBC-8	18
10RC-14F	24	11807	58	13659	65	14RBD-182	39
10RC-14FL	25	11808	58	13760	120	14RBD-18277	39
10RC-14FLX	26	11809	58	13797	134	14RBD-183	39
10RC-14FX	25	11810	58	13810	67, 134	14RBD-18377	39
10RC-14X	13	11811	58	14RB-10	12	14RBD-187	40
10RC-250F	37	11821	58	14RB-10CP	52	14RBD-188	40
10RC-250FCP	52	11822	58	14RB-10F	24	14RBS-251TX	36
10RC-250T	40	11823	58	14RB-10FCP	52	18RA-10	12
10RC-251T	40	11824	58	14RB-10FL	25	18RA-10CP	52
10RC-2577	37	11825	58	14RB-10FLX	26	18RA-10F	24
10RC-38	12	11826	58	14RB-10FX	25	18RA-10FCP	52
10RC-38X	13	11827	58	14RB-10X	13	18RA-10FL	25
10RC-516	12	11828	58	14RB-14	12	18RA-10FLX	26
10RC-516X	13	11829	58	14RB-14F	24	18RA-10FX	25
10RC-55PT	27	12050	59	14RB-14X	13	18RA-10X	13
10RC-6	12	12051	59	14RB-250F	37	18RA-14	12
10RC-6F	24	12052	59	14RB-250FCP	52	18RA-14X	13
10RC-6FL	25	12054	59	14RB-250T	40	18RA-250F	37
10RC-6FLX	26	12055	59	14RB-251T	40	18RA-250FCP	52
10RC-6X	13	12056	59	14RB-2577	37	18RA-250T	40
10RC-8	12	12057	59	14RB-38	12	18RA-251T	40
10RC-8F	24	12058	59	14RB-38X	13	18RA-2577	37
10RC-8FCP	52	12059	59	14RB-4	12	18RA-38	12
10RC-8FL	25	12060	59	14RB-47PT	27	18RA-38X	13
10RC-8FLX	26	12061	59	14RB-4X	13	18RA-4	12
10RC-8FX	25	12062	59	14RB-516	12	18RA-47PT	27
10RC-8X	13	13100A	133	14RB-516X	13	18RA-4X	13
10RCS-251TX	36	13400	63, 133	14RB-6	12	18RA-516	12
11732	64	13589A	67, 120, 134	14RB-6CP	52	18RA-6	12
11733	64	13600	66, 120, 134	14RB-6F	24	18RA-6F	24
11734	64	13600S	67	14RB-6FCP	52	18RA-6FCP	52
11735	64	13606	120	14RB-6FL	25	18RA-6FL	25
11736	64	13610A	66, 134	14RB-6FLX	26	18RA-6FLX	26
11737	64	13611	67, 134	14RB-6FS	24	18RA-6FX	25
11738	64	13612	67, 134	14RB-6FX	25	18RA-6X	13
11739	64	13613	134	14RB-6X	13	18RA-8	12
11740	64	13614	134	14RB-8	12	18RA-8CP	52
11771	64	13618	67, 134	14RB-8CP	52	18RA-8F	24
11781M	64	13619	67, 120, 134	14RB-8F	24	18RA-8FCP	52
11782M	64	13620	67, 120, 134	14RB-8FCP	52	18RA-8FL	25
11783M	64	13640	120	14RB-8FL	25	18RA-8FLX	26

Appendix

Part number index

Cat. no.	Page	Cat. no.	Page	Cat. no.	Page	Cat. no.	Page
18RA-8FX	25	21735	65	2B-16	30	54131	97
18RA-8X	13	21736	65	2C-10	30	54132	97
18RAD-182	39	21737	65	2C-12	30	54134	97
18RAD-18277	39	21738	65	2D-8	30	54135	97
18RAD-183	39	21739	65	2E-6	30	54136	97
18RAD-18377	39	21740	65	2F-4	30	54138	97
18RAD-187	40	21741	65	2G21	30	54139	97
18RAD-188	40	220001	123	2RA18	29	54140	97
18RAS-251TX	36	220002-TB	123	2RA18X	28	54142	97
204210-1	125	220004	123	2RA18XCP	52	54143	97
204210-1H	125	220006	123	2RAA	28	54145	97
204210-2	125	220015	123	2RAS18X	36	54147	97
204210-3	125	220016	123	2RB14	29	54148	97
204210-3H	125	220017	125	2RB14X	28	54150	97
204210-5	125	220018	125	2RB14XCP	52	54152	97
204210MT	124	220019	123	2RBB	28	54153	97
204210S	123	220020	123	2RBS14X	36	54155	97
204210SH	123	220021	125	2RC10	29	54157	97
204212	125	220022	125	2RC10X	28	54158	97
204217	125	220023	123	2RC10XCP	52	54160	97
204MT14	124	220024	123	2RCC	28	54162	97
204MT38	124	220025	125	2RCS10X	36	54163	97
204T14	127	220026	125	2RD8	29	54165	97
204T38	127	22F061	126	2RE6	29	54167	97
210214-1	125	22F066	126	2RF4	29	54168	97
210214-2	125	22F081	126	2RZZ	28	54170	97
210214-3	125	22F086	126	314118S	123	54172	98
210214MT	124	22F101	126	314123	125	54173	98
210214S	123	22F106	126	314125	125	54174	98
210216	125	22L001	123	54104	97	54178	98
210216F	126	22L002	123	54105	97	54179	98
210217	125	22L004	123	54106	97	54181	98
210217F	126	22L006	123	54107	97	54183	98
210219	125	22L008	123	54108	97	54185	98
210219F	126	22L009	123	54109	97	54187	98
210MT14	124	22L009H	123	54110	97	54204	97
210MT38	124	22L010	123	54111	97	54205	97
214420	123	22LF01	126	54112	97	54206	97
21707M	64	22LF06	126	54113	98	54207	97
21708M	64	22LM01	126	54114	98	54208	97
21709M	64	22LM06	126	54115	98	54209	97
21710M	64	22R061	125	54116	98	54210	97
21711M	64	22R081	125	54118	98	54211	97
21712M	64	22R086	125	54120	98	54212	97
21713M	64	22R101	125	54122	98	54213	98
21714M	64	22R106	125	54123	98	54214	98
21715M	64	22R146	125	54124	98	54215	98
21731	65	25000	62	54126	98	54216	98
21732	65	2A-18	30	54128	98	54218	98
21733	65	2A20	30	54129	98	54220	98
21734	65	2B-14	30	54130	97	54222	98

Appendix

Part number index

Cat. no.	Page	Cat. no.	Page	Cat. no.	Page	Cat. no.	Page
54223	98	54750	97	54928	98	60154	98
54224	98	54755	98	54930	97	60156	98
54226	98	54760	98	54942	97	60157	98
54228	98	54765	98	54947	97	60159	98
54255	97	54770	98	54965	97	60160	98
54260	97	54775	98	54970	97	60162	98
54265	97	54780	98	58161	98	60163	98
54270	97	54804	97	58162	98	60165	98
54275	98	54805	97	58163	98	60166	98
54280	98	54806	97	58165	98	60168	98
54282	98	54807	97	58166	98	60169	98
54286	98	54809	98	60096	97	60171	98
54289	98	54810	98	60097	97	60172	98
54291	98	54811	98	60099	97	60174	98
54295	98	54812	98	60101	97	60176	98
54504	97	54813	98	60102	97	60178	98
54505	97	54814	98	60103	97	60180	98
54506	97	54815	98	60104	97	60184	98
54507	97	54816	98	60106	97	60230	97
54509	97-98	54817	98	60107	97	60236	97
54510	97-98	54820	98	60108	97	60238	97
54511	97-98	54823	98	60109	97	60242	97
54512	98	54828	98	60112	97	60244	97
54513	98	54850	97	60113	97	60248	97
54514	98	54852	97	60114	97	60250	97
54515	98	54854	97	60116	97	60254	98
54516	98	54856	97	60117	97	60256	98
54518	98	54858	97	60118	97	60260	98
54520	98	54860	97	60120	97	60262	98
54522	98	54862	97	60122	97	60265	98
54523	98	54864	97	60123	97	60267	98
54524	98	54866	97	60124	97	60268	98
54526	98	54868	98	60126	97	60269	98
54528	98	54870	98	60128	97	60271	98
54610	97	54872	98	60129	97	60273	98
54615	97	54874	98	60130	97	60274	98
54620	97	54876	98	60132	97	60275	98
54625	97	54878	98	60134	97	60276	98
54630	97	54880	98	60135	97	60277	98
54635	97	54882	98	60136	97	60278	98
54640	98	54905	97	60138	97	60280	98
54645	98	54906	97	60140	97	60284	98
54650	98	54909	97	60141	97	60500	97
54710	97	54910	97	60142	97	60501	97
54715	97	54913	98	60144	97	60507	97
54720	97	54914	98	60147	97	60512	97
54725	97	54915	98	60148	97	60516	97
54730	97	54916	98	60150	97	60522	98
54735	97	54918	98	60151	97	60530	98
54740	97	54920	98	60152	98	60538	98
54745	97	54923	98	60153	98	60542	98

Appendix

Part number index

Cat. no.	Page	Cat. no.	Page	Cat. no.	Page	Cat. no.	Page
60548	98	A18-12	15	AD18-183	39	B65-TB	26
60554	98	A18-14	15	AD182	39	B71	15
60560	98	A18-250	38	AD183	39	B72	15
60565	98	A18-250A	38	B10-TB	41	B73	15
60568	98	A18-250T	40	B115	26	B75-TB	15
60571	98	A18-251T	40	B11-TB	41	B85	15
60574	98	A18-38	15	B132	15	B85G	79
60576	98	A18-4	15	B133	15	B86	15
60578	98	A18-516	15	B134	15	B87	15
60580	98	A18-6	15	B14-10	15	B87G	79
60584	98	A18-6F	26	B14-10F	26	BAIR22-6	62, 131
60905	97	A18-6FL	27	B14-10FL	27	BAT22-6	60, 130
60910	97	A18-8	15	B14-110F	41	BB2	30
60915	97	A18-8F	26	B14-111F	41	BC14-10	19
60920	97	A18-8FL	27	B14-12	15	BC14-12	19
60925	97	A18-PS-M	31	B14-14	15	BC14-14	19
60930	98	A221	27	B14-14F	26	BC14-38	19
60935	98	A224	27	B14-250	38	BC14-516	19
60940	98	A225	27	B14-250A	38	BC14-6	19
60945	98	A250	38	B14-250F	38	BC14-8	19
60950	98	A251	40	B14-250T	40	BC71	19
60955	98	A252G	38	B14-251T	40	BC72	19
60960	98	A47PT	27	B14-38	15	BC75	19
60965	98	A480	21	B14-4	15	BC79	19
60970	98	A481	21	B14-516	15	BC85	19
60975	98	A482	21	B14-6	15	BC86	19
60980	98	A483	21	B14-6F	26	BC87	19
60985	98	A484	21	B14-6FL	27	BD14-182	39
63105	97	A485	21	B14-8	15	BD14-183	39
63110	98	A486	21	B14-8F	26	BD183	39
63115	98	A71	15	B14-8FL	27	C10-10	15
63120	98	A72	15	B14-D	42	C10-10A	22
63125	98	A73	15	B14-PS-M	31	C10-10F	26
63130	98	A75	15	B19	26	C10-10FL	27
63135	98	A85	15	B220	27	C10-12	15
63140	98	A85G	79	B223	27	C10-14	15
63145	98	A86	15	B225	27	C10-14F	26
63150	98	A87	15	B23	42	C10-14FL	27
63155	98	A87G	79	B250	38	C10-250A	38
63160	98	AA2	30	B250G	38	C10-250F	38
63165	98	AB14-10A	22	B251	40	C10-251T	40
A10-TB	41	AB14-6A	22	B252G	38	C10-38	15
A11	41	AB14-8A	22	B47PT	27	C10-516	15
A114	26	AB51	22	B480	21	C10-6F	26
A115-TB	26	AB52	22	B481	21	C10-6FL	27
A116	26	AB53	22	B482	21	C10-6-SK	15
A18-10	15	AC 5 x 3	97	B483	21	C10-8A	22
A18-10F	26	AC 5 x 7	97	B484	21	C10-8F	26
A18-10FL	27	AC 85 x 105	97	B485	21	C10-8FL	27
A18-110F	41	AC 85 x 75	97	B486	21	C10-8-SK	15
A18-111F	41	AD18-182	39	B64	26	C10-PS-D	31

Appendix

Part number index

Cat. no.	Page	Cat. no.	Page	Cat. no.	Page	Cat. no.	Page
C114	26	CPO187	93	D8-516	16	F10711	17
C115	26	CPO187-0-6	93	D8-PS-D	31	F10721	17
C116-TB	26	CPO250	93	D975	17	F10731	17
C133	26	CPO250-0-6	93	DD102	30	F2020	46
C220-TB	27	CPO375	93	DIE1801	130-131	F2021	46
C221	27	CPO375-0-6	93	DIE1802	130-131	F2022	46
C222	27	CPO500	93	DIE1804	130-131	F2023	46
C250	38	CPO500-0-6	93	DIE1806	130-131	F2024	46
C252G	38	CPO63	93	DIE2001	60-62	F2025	46
C26	15	CPO63-0-6	93	DIE2002	60-62	F2026	46
C33	15	CPO750	93	DIE2005	60-62	F2027	46
C36	15	CPO750-0-6	93	DIE2007	60-62	F2028	46
C480	21	CPO93	93	DT22-10	45	F2029	46
C481	21	CPO93-0-6	93	DWS02	57	F2030	46
C482	21	CPO-A-125-48	95	E10261	17	F2031	47
C483	21	CPO-A-187-48	95	E10711	17	F2032	47
C484	21	CPO-A-250-48	95	E10721	17	F2033	47
C485	21	CPO-A-375-48	95	E10731	17	F2034	47
C486	21	CPO-A-500-48	95	E226	22	F2035	47
C51	22	CPO-A-750-48	95	E26	16	F2036	47
C52	22	D10161	17	E271	22	F2037	47
C53	22	D-101A	111	E272	22	F2038	47
C55PT	27	D-101B	111	E6-10	16	F2039	47
C70	15	D10361	17	E6-12	16	F2040	47
C71	15	D10711	17	E6-14	16	F2041	47
C72	15	D10721	17	E6-38	16	F2042	47
C73	15	D10731	17	E6-516	16	F2043	47
C75	15	D-201C	111	E6-PS-D	31	F2044	47
C77	15	D-201D	111	E71	16	F2045	47
CC2	30	D-201E	111	E72	16	F2046	47
CHS100	96	D-201F	111	E73	16	F2047	47
CHS100B	96	D226	22	E75	16	F2048	47
CHS112	96	D236	22	EE2	30	F2049	47
CHS112B	96	D26	16	ERG1801	129	F2050	47
CHS12	96	D271	22	ERG1802	129	F2051	47
CHS12B	96	D-301G	111	ERG1804	129	F2052	47
CHS14	96	D-301H	111	ERG1806	129	F2053	47
CHS14B	96	D-301J	111	ERG1-WS	57	F2054	47
CHS18	96	D36	16	ERG4	50	F226	22
CHS18B	96	D-401K	111	ERG4001	55	F250TA	41
CHS200	96	D-401L	111	ERG4002	55	F26	16
CHS200B	96	D-401M	111	ERG4004	55	F271	22
CHS34	96	D-401N	111	ERG4005	55	F272	22
CHS34B	96	D71	16	ERG4006	55-56	F273	22
CHS38	96	D72	16	ERG4007	55	F4000	50
CHS38B	96	D73	16	ERG4008	55	F4001	50
CHS-KIT	93	D75	16	ERG4255	56	F4002	50
CPO1000	93	D8-10	16	ERG740	110	F4003	50
CPO1000-0-6	93	D8-12	16	ERG740-01	110	F4004	46
CPO125	93	D8-14-SK	16	ERG811	129	F4005	46
CPO125-0-6	93	D8-38	16	F10261	17	F4006	46

Appendix

Part number index

Cat. no.	Page	Cat. no.	Page	Cat. no.	Page	Cat. no.	Page
F4007	46	F9021	51	GSB115	115	GSC281	115
F4008	46	F9022	51	GSB124	115	GSC287	115
F4009	46	F9023	51	GSB128	115	GSC297	115
F4020	50	F9024	51	GSB134	115	GSC312	115
F4021	50	F9025	51	GSB1353	119	GSC327	115
F4023	50	F9026	51	GSB1425	119	GSC348	115
F4024	50	F9027	51	GSB149	115	GSC359	115
F4027	50	F9028	51	GSB156	115	GSC375	115
F4028	50	F9029	51	GSB165	115	GSC405	115
F4-10	16	F9030	51	GSB175	115	GSC415	115
F4-12	16	F9031	51	GSB187	115	GSC425	115
F4-14	16	F9032	51	GSB194	115	GSC460	115
F4-38	16	F9033	51	GSB205	115	GSC500	115
F4-516	16	F9034	51	GSB219	115	GSC590	119
F4-PS-W	31	F9035	51	GSB225	115	GSC710	119
F71-TB	16	F9036	51	GSB232	115	GSC840	119
F72	16	F9037	51	GSB250	115	H1/0-PS-C	31
F73	16	F9038	51	GSB261	115	H10-14	17
F75	16	F9039	51	GSB266	115	H672	22
F8000	49	F975	17	GSB275	115	H673	22
F8001	49	FF2	30	GSB281	115	H971	17
F8002	49	FPW12	127	GSB287	115	H972	17
F8003	49	FPW14	127	GSB297	115	H973	17
F8005	49	FPW38	127	GSB312	115	H975	17
F8006	49	FPW516	127	GSB348	115	HS12-30	87
F8007	49	FPW58	127	GSB375	115	HS12-40	87
F8008	49	FTA250	41	GSB430	119	HS12-6	87
F8009	49	G2-12	17	GSB550	119	HS12-6-25	87
F8010	49	G2-14	17	GSB670	119	HS12-6-4	87
F8011	49	G2-38	17	GSB810	119	HS12-6L	87
F9000	51	G2-516	17	GSB920	119	HS12-6LR	87
F9001	51	G2-PS-W	31	GSC101	115	HS16-12	87
F9002	51	G671	22	GSC1010	119	HS16-12-25	87
F9003	51	G672	22	GSC1130	119	HS16-12-4	87
F9004	51	G673	22	GSC1250	119	HS16-12L	87
F9005	51	G926	17	GSC128	115	HS30-30	87
F9006	51	G971	17	GSC1440	119	HS30-4	87
F9007	51	G972	17	GSC149	115	HS30-40	87
F9008	51	G973	17	GSC156	115	HS40-400	87
F9009	51	G975	17	GSC1563	119	HS40-400-25	87
F9010	51	GG2	30	GSC1670	119	HS40-400-4	87
F9011	51	GSB046	115	GSC175	115	HS40-400L	87
F9012	51	GSB058	115	GSC187	115	HS40-4-TB	87
F9013	51	GSB063	115	GSC194	115	HS4-30	87
F9014	51	GSB071	115	GSC199	115	HS4-30-25	87
F9015	51	GSB080	115	GSC205	115	HS4-30-4	87
F9016	51	GSB090	115	GSC219	115	HS4-30L	87
F9017	51	GSB096	115	GSC225	115	HS4-30LR	87
F9018	51	GSB101	115	GSC232	115	HS500-1000	87
F9019	51	GSB1040	119	GSC261	115	HS500-1000-25	87
F9020	51	GSB109	115	GSC275	115	HS500-1000-4	87

Appendix

Part number index

Cat. no.	Page	Cat. no.	Page	Cat. no.	Page	Cat. no.	Page
HS500-1000L	87	HSTS25	100	NW10-10	20	RA18-516	8
HS6-1	87	J2/0-PS-C	31	NW10-12	20	RA18-6	8
HS6-1-25	87	J20-38	17	NW10-8	20	RA18-6F	23
HS6-1-4	87	J672	22	NW14-10	20	RA18-6FL	23
HS6-1L	87	J673	22	NW14-12	20	RA18-6FS	24
HS6-1LR	87	J675	22	NW14-8	20	RA18-8	8
HSB120-50-3	91	J971	17	NW18-10	20	RA18-8F	23
HSB125-50-4	91	J972	17	NW52	20	RA18-8FL	23
HSB170-82-3	91	J973	17	NW81	20	RA18-8FS	24
HSB175-82-4	91	J974	17	NW83	20	RA18D	42
HSB200-75-2	91	J975	17	NW84	20	RA2213	23
HSB240-112-3	91	J976	17	P400-PS-X	31	RA2217	25
HSB265-120-4	91	K3/0-PS-L	31	PAIR22-6	61, 131	RA2217-170	26
HSB350-138-3	91	K30-38	17	PT60M	33	RA2227	25
HSB430-157-3	91	K672	22	PT66M	33	RA2243	23
HSB490-200-3	91	K673	22	PT6M	33	RA2247	25
HSB520-135-4	91	K675	22	PT70	33	RA2253	23
HSC2-20	90	K971	17	PT70M	33	RA2257	25
HSC300	90	K972	17	PT80	33	RA2257-170	26
HSC300-600	90	K973	17	R500-PS-V	31	RA23	42
HSC30-250	90	K974	17	RA10-SK	41	RA250	37
HSC500	90	K975	17	RA11	41	RA250P	38
HSC700-1000	90	L4/0-PS-L	31	RA1103	23	RA2517	40
HSC750	90	L40-38	17	RA1123	23	RA25177	40
HSC8-4	90	L971	17	RA1147	24	RA257	37
HSFR12-6-4	89	L972	17	RA1147-170	25	RA257-170	37
HSFR16-12-4	89	L973	17	RA1153	23	RA2573	37
HSFR40-400-4	89	L974	17	RA1157	24	RA2577F	38
HSFR4-30-4	89	L975	17	RA1157-170	25	RA323	8
HSFR500-1000-4	89	LD2	44	RA1163	23	RA333	8
HSFR6-1-4	89	LD2-D	44	RA1167	24	RA47PT	27
HSHR1300-4	88	LD2P-D	43	RA1167-170	25	RA480	21
HSHR1750-4	88	LD2P-Q	43	RA1203	24	RA481	21
HSHR2000-4	88	LD3	44	RA1223	24	RA482	21
HSHR2750-4	88	LD3-D	44	RA1253	24	RA483	21
HSHR3500-4	88	M250-38	17	RA147PT	27	RA484	21
HSHR4700-4	88	M250-PS-Q	31	RA18-10	8	RA485	21
HSHR750-4	88	M673	22	RA18-10F	23	RA486	21
HS-KIT	93	M675	22	RA18-10FL	23	RA713	8
HSMW1100-48	92	M972	17	RA18-10FS	24	RA717	12
HSMW1300-48	92	M973	17	RA18-110F	41	RA723	8
HSMW1500-48	92	M974	17	RA18-111F	41	RA727	12
HSMW1700-48	92	M975	17	RA18-12	8	RA727-170	13
HSMW2050-48	92	MSC14	102	RA18-14	8	RA733	8
HSMW2750-48	92	MSC2	102	RA18-14F	23	RA737	12
HSMW3500-48	92	MSC20	102	RA18-250A	38	RA753	8
HSMW400-48	92	MSC250	102	RA18-250F	37	RA77	12
HSMW4700-48	92	MSC500	102	RA18-250FP	38	RA833	8
HSMW6700-48	92	MSC8	102	RA18-38	8	RA853	8
HSMW750-48	92	MSCV20	101	RA18-4	8	RA857	12
HSMW9000-48	92	N300-PS-X	31	RA18-47PT	27	RA857-170	13

Appendix

Part number index

Cat. no.	Page	Cat. no.	Page	Cat. no.	Page	Cat. no.	Page
RA863	8	RB11-TB	41	RB2237	25	RB867	12
RA867	12	RB1203	24	RB2237-200	26	RB867-200	13
RA867-170	13	RB1204	24	RB2253	23	RB873	9
RA873	8	RB1223	24	RB2254	23	RB874	9
RA877	12	RB1224	24	RB2257	25	RB877	12
RA877-170	13	RB1253	24	RB2257-200	26	RB877-200	13
RAA21	29	RB1323	9	RB23	42	RBB21	29
RAA217	28	RB1327	12	RB250	37	RBB217	28
RAA217-170	28	RB1333	9	RB250P	38	RBB217-200	28
RAA23	28	RB14-10	9	RB2517	40	RBB23	28
RAA24	30	RB14-10F	23	RB25177	40	RBB25	30
RAAS22X	36	RB14-10FL	23	RB257	37	RBB250	41
RAAT21	29	RB14-10FS	24	RB257-200	37	RBBS22X	36
RAD18-182	39	RB14-10X	9	RB2573	37	RBBT21	29
RAD18-183	39	RB14-110F	41	RB2577F	38	RBC14-10	18
RAD18-187A	39	RB14-111F	41	RB4, RB44, RB4-10M	34	RBC14-12	18
RAD18-188A	39	RB14-12	9	RB44	32	RBC14-14	18
RAD1823	39	RB14-14	9	RB44-HT	34	RBC14-38	18
RAD1827	39	RB14-14F	23	RB47PT	27	RBC14-516	18
RAD18277	39	RB14-14X	9	RB480	21	RBC14-6	18
RAD1833	39	RB14-250	41	RB481	21	RBC14-8	18
RAD1837	39	RB14-250A	38	RB482	21	RBC713	18
RAD18377	39	RB14-250F	37	RB483	21	RBC717	18
RAD1877F	39	RB14-250FP	38	RB484	21	RBC727	18
RAD1887F	39	RB14-38	9	RB485	21	RBC753	18
RAS18-10FLX	35	RB14-38X	9	RB486	21	RBC797	18
RAS18-10X	35	RB14-4	9	RB4-HT	34	RBC857	18
RAS18-250AX	36	RB14-47PT	27	RB4-TB	32	RBC863	18
RAS18-6FLX	35	RB14-4X	9	RB4-TB/RB44	32	RBC867	18
RAS18-6X	35	RB14-516	9	RB647	24	RBC877	18
RAS18-8FLX	35	RB14-516X	9	RB647-200	25	RBD14-182	39
RAS18-8X	35	RB14-6	9	RB657	24	RBD14-183	39
RAT713	20	RB14-6F	23	RB657-200	25	RBD14-187A	39
RAT853	20	RB14-6FL	23	RB713	9	RBD14-188A	39
RAT863	20	RB14-6FS	24	RB714	9	RBD1823	39
RAT873	20	RB14-6X	9	RB717	12	RBD1827	39
RAX103	8	RB147PT	27	RB717-200	13	RBD18277	39
RAX23	8	RB14-8	9	RB723	9	RBD1833	39
RAX43	8	RB14-8F	23	RB724	9	RBD1837	39
RAX63	8	RB14-8FL	23	RB727	12	RBD18377	39
RAX83	8	RB14-8FS	24	RB733	9	RBD1877F	39
RB10-SK	41	RB14-8X	9	RB734	9	RBD1887F	39
RB1103	23	RB14D	42	RB737	12	RBS14-10FLX	35
RB1113	23	RB1717	24	RB753	9	RBS14-10X	35
RB1123	23	RB2207	25	RB757	18	RBS14-250AX	36
RB1124	23	RB2207-200	26	RB853	9	RBS14-6FLX	35
RB1153	23	RB2213	23	RB854	9	RBS14-6X	35
RB1154	23	RB2214	23	RB857	12	RBS14-8FLX	35
RB1157	24	RB2217	25	RB857-200	13	RBS14-8X	35
RB1157-200	25	RB2217-200	26	RB863	9	RBT713	20
RB1163	23	RB2233	23	RB864	9	RBT853	20

Appendix

Part number index

Cat. no.	Page	Cat. no.	Page	Cat. no.	Page	Cat. no.	Page
RBT863	20	RC2217	25	RCC21	29	RE6-12	10
RBT873	20	RC2223	23	RCC217	28	RE6-14	10
RC10-10	9	RC2224	23	RCC217-250	28	RE6-38	10
RC10-10F	23	RC2227	25	RCC23	28	RE6-516	10
RC10-10FL	23	RC2227-250	26	RCC26	30	RE717	10
RC10-10FS	24	RC2233	23	RCCS22X	36	RE727	10
RC10-10X	9	RC2237	25	RCCT21	29	RE737	10
RC10-12	9	RC250	37	RCS10-10FLX	35	RE757	10
RC10-12X	9	RC2517	40	RCS10-10X	35	REE28	29
RC10-14	9	RC25177	40	RCS10-14FLX	35	REV267	14
RC10-14F	23	RC257	37	RCS10-14X	35	REV717	14
RC10-14FL	23	RC2573	37	RCS10-250AX	36	REV727	14
RC10-14X	9	RC2577F	38	RCS10-6FLX	35	REV737	14
RC10-250A	38	RC333	9	RCS10-6X	35	REV757	14
RC10-250F	37	RC334	9	RCS10-8FLX	35	RF10261	10
RC10-38	9	RC337	12	RCS10-8X	35	RF10711	10
RC10-38X	9	RC337-250	13	RCT333	20	RF10721	10
RC10-516	9	RC363	9	RCT363	20	RF10731	10
RC10-516X	9	RC364	9	RCT703	20	RF267	10
RC10-55PT	27	RC367	12	RCT713	20	RF4-10	10
RC10-6	9	RC367-250	13	RCT733	20	RF4-14	10
RC10-6F	23	RC480	21	RCT863	20	RF4-38	10
RC10-6FL	23	RC481	21	RD10161	10	RF4-516	10
RC10-6X	9	RC482	21	RD10361	10	RF717	10
RC10-8	9	RC483	21	RD10711	10	RF727	10
RC10-8F	23	RC484	21	RD10721	10	RF737	10
RC10-8FL	23	RC485	21	RD10731	10	RF757	10
RC10-8FS	24	RC486	21	RD167	10	RG2-10	11
RC10-8X	9	RC55	32	RD367	10	RG2-12	11
RC1113	23	RC551-HT	34	RD717	10	RG2-14	11
RC1123	23	RC55PT	27	RD727	10	RG2-38	11
RC1124	23	RC6	32	RD737	10	RG2-516	11
RC1147	24	RC6, RC6-5M, RC55	34	RD757	10	RG267	11
RC1147-250	25	RC6/RC55	32	RD8-10	10	RG717	11
RC1153	23	RC6-HT	34	RD8-12	10	RG727	11
RC1154	23	RC703	9	RD8-14	10	RG737	11
RC1157	24	RC704	9	RD8-38	10	RG757	11
RC1157-250	25	RC707	12	RD8-516	10	RG9711	11
RC1163	23	RC713	9	RDD27	29	RG9731	11
RC1167	24	RC714	9	RDV167	14	RG9751	11
RC1223	24	RC717	12	RDV367	14	RH717	11
RC1224	24	RC717-250	13	RDV717	14	RH727	11
RC1253	24	RC733	9	RDV727	14	RH737	11
RC1254	24	RC734	9	RDV737	14	RH757	11
RC1337	24	RC737	12	RDV757	14	RH9711	11
RC155PT	27	RC737-250	13	RE10261	10	RH9731	11
RC2203	23	RC753	9	RE10711	10	RH9751	11
RC2204	23	RC777	12	RE10721	10	RJ717	11
RC2207	25	RC777-250	13	RE10731	10	RJ727	11
RC2207-250	26	RC863	9	RE267	10	RJ737	11
RC2213	23	RC864	9	RE6-10	10	RJ757	11

Appendix

Part number index

Cat. no.	Page	Cat. no.	Page
RJ9711	11	wt115A	57
RJ9731	11	WT129	56
RJ9751	11	WT1377	56
RK717	11	WT1400	103
RK727	11	WT161M	54
RK737	11	WT2000	54
RK9721	79	WT2130A	56
RK9731	11	WT3185	56
RK9751	11	WT440	116
RL737	11	WT540	116
RL757	11	WT-PTORCH	103
RL9731	11		
RL9751	11		
RM737	11		
RM747	11		
RM757	11		
RM9731	11		
RM9751	11		
RP12	32		
RP12-HT	34		
RP7	32		
RP7, RP-12	34		
RP7/RP12	32		
RP7-HT	34		
RSK-101	108		
RSK-201	108		
RSK-301	108		
RSK-401	108		
RSK-LEHRE	111		
RZ22-10	8		
RZ22-2	8		
RZ22-4	8		
RZ22-6	8		
RZ22-8	8		
RZZ23	28		
STAKIT	53		
STA-ORG	53		
SWS01	57		
T1	50		
T3	50		
TBFP9-2	99		
TBFT201-36	99		
TBFT421-36	99		
TBM15I	134		
TBM6	58		
TBM6H	132		
TBM6S	58		
VBC-1	57		
WT110M	54		
WT111M	54		
WT112M	54		

Additional information

We reserve the right to make technical changes or modify the contents of this document without prior notice. With regard to purchase orders, the agreed particulars shall prevail. ABB AG does not accept any responsibility whatsoever for potential errors or possible lack of information in this document.

We reserve all rights in this document and in the subject matter and illustrations contained therein. Any reproduction, disclosure to third parties or utilization of its contents – in whole or in parts – is forbidden without prior written consent of ABB AG.



—
US

ABB Installation Products
Electrification business
860 Ridge Lake Blvd.
Memphis, TN 38120
+1 901-252-5000

tnb.abb.com

For other ABB locations visit new.abb.com/low-voltage